

# Valadares

ORIGINAL BATHROOMS

SINCE 1921



# 2022

TABELA DE PREÇOS  
TARIFA DE PRECIOS  
PRICE LIST



# Índice | Index



COLEÇÕES SANITÁRIAS  
COLECCIONES SANITARIAS  
SANITARY COLLECTIONS

012



ESTRUTURAS  
ESTRUCTURAS  
STRUCTURES

066



LAVATÓRIOS  
LAVABOS  
WASHBASINS

074



MÓVEIS  
MUEBLES  
FURNITURE

110



TORNEIRAS  
GRIFERIA  
TAPS

118



ESPAÇOS PÚBLICOS  
ESPACIOS PÚBLICOS  
PUBLIC SPACES

178



BASES DE CHUVEIRO  
PLATOS DE DUCHA  
SHOWER TRAYS

204



BANHEIRAS  
BAÑERAS  
BATHTUBS

214



RESGUARDOS  
MAMPARAS  
SHOWER CABINS

224



ACESSÓRIOS CERÂMICOS  
ACCESORIOS EN CERÁMICA  
CERAMIC ACCESSORIES

234

<b>COMPACTA / CLOSE COUPLED</b>		<b>NORMAL</b>
Preço/ Precio/ Price		Preço/ Precio/ Price
Bacia+tanque+mec.+tampo SC		Bacia+tampo
Inodoro+tanque+mec.+tapa SC		Inodoro+tapa
WC+cistern+mechan.+SC seat		WC+seat
Branco/ Blanco/ White	<b>PAG.</b>	Branco/ Blanco/ White

EGG	1.033 €	<b>20</b>	
NAUTILUS RIMLESS	612 €	<b>25</b>	
ONE	578 €	<b>30</b>	
TWO	449 €	<b>34</b>	
TWO RIMLESS			
LIGHT			
NEOCLÁSSICA*	594 €	<b>42</b>	681 €
100 RIMLESS	392 €	<b>51</b>	
OPUS	290 €	<b>55</b>	
OCEANUS **	185 €	<b>60</b>	113 €

\* O conjunto Neoclássica Normal considerada é Neoclássica com tanque alto. Neste caso estão considerados bacia + tanque + mecanismo + tampo SC

El conjunto Neoclássica Normal considerado es Neoclássica con tanque alto. En este caso, se considera lavabo + tanque + mecanismo + tapa SC

The set Neoclássica Normal is Neoclássica with high level cistern. In this case includes WC + Cistern + mechanism + SC seat

\*\* Conjunto Oceanus apenas dispõe de tampo de descida normal

El conjunto Oceanus solo tiene tapa de queda normal  
Oceanus set only has normal toilet seat

<b>BTW</b>		<b>SUSPENSA SUSPENDIDA WALL HUNG</b>	
	Preço/ Precio/ Price		Preço/ Precio/ Price
	Bacia+tampo SC		Bacia+tampo SC
	Inodoro+tapa SC		Inodoro+tapa SC
	WC+SC seat		WC+SC seat
<b>PAG.</b>	Branco/ Blanco/ White	<b>PAG.</b>	Branco/ Blanco/ White
	525 €	<b>21</b>	504 €
			404 €
			338 €
			247 €
	294 €	<b>35</b>	259 €
			341 €
<b>44</b>	437 €	<b>46</b>	523 €
			224 €
	199 €	<b>56</b>	198 €
<b>61</b>			119 €
			<b>62</b>

**Coleções** | Colecciones | Collections

<b>Cores</b> Colores Colors	<b>Egg</b>	<b>Nautilus</b>	<b>One</b>	<b>Neoclassica</b>	<b>Two</b>	<b>Light</b>	<b>100</b>	<b>Opus</b>
00 - Branco Blanco White	•	•	•	•	•	•	•	•
07 - Azul York York Blue	•		•	•				
12 - Azul Pastel Pastel Blue								
13 - Rosa Imperial Imperial Rose	•							
15 - Cappuccino	•	•	•					
18 - Amarelo Saara Amarillo Saara Saara Yellow	•		•					
20 - Pergamon				•				
21 - Azul Capri Capri Blue								
23 - Branco Ártico Blanco Ártico White Artic	•	•	•	•	•	•		
27 - Verde Amazônia Amazon Green								
28 - Verde Jade Jade Green								
33 - Cereja Cereza Cherry								
37 - Cinza Basalto Gris basalto Gray Basalt	•		•					
38 - Cinza Bruma Gris Bruma Gray Bruma	•	•	•					
41 - Rosa Quartzo Rosa Cuarzo Rose Quartz	•		•					
44 - Azul Petróleo Blue Petroleum	•		•			•		
46 - Marfim Marfil Ivory								
47 - Ardósia Pizarra Slate	•	•	•	•	•	•		
48 - Preto Negro Black	•	•	•	•	•	•		
50 - Cacau Cacao Cocoa								
98 - Branco-Preto Blanco-Negro White - Black						•		
10 - HighPor								
60 - HighCer								

# o seu menu de cores

su menu de colores

your color menu



Oceanus	Junior	Infantil	PMR	Urinois Urinaris Urinals	Lavatórios Pousar Sobre mueble Standing	Lavatórios Especiais Especiales specials	Outros Lavatórios Otros Lavabos Other Washbasins	Bases de Chuveiro Platos de ducha Shower trays	Peças técnicas Piezas técnicas Technical pieces	Acessórios Accesorios Accessories	Torneiras Luna Grifo luna Tap luna	Placa Cerâmica Encim- nera cerâmica Ceramic Top
•	•	•	•	•	•	•	•	•	•	•	•	•
					•							
					•							
					•							
					•							
					•							
					•							
					•	•					•	•
					•							
					•	•						
					•							
					•							
					•	•						
	•			•	•	•	•				•	•
					•							
								•				
					•			•			•	•

# informações

información · information

## abreviaturas

abreviaturas · abbreviations

	<b>PT</b>	<b>ES</b>	<b>EN</b>
<b>SC</b>	Tampo soft-close	Tapa soft-close	Soft-close toilet seat
<b>CM</b>	Tampo em contraplacado marítimo	Tapa en laminado marino	Toilet seat in marine plywood
<b>V</b>	Bacia de descarga vertical	Inodoro de descarga vertical	Vertical outlet WC
<b>H</b>	Bacia de descarga horizontal	Inodoro de descarga horizontal	Horizontal outlet WC
<b>VCC</b>	Válvula clic-clac	Válvula clic-clac	Pop-up waste
<b>DD</b>	Mecanismo de dupla descarga	Mecanismo de doble descarga	Dual flush mechanism
<b>PMR</b>	Pessoas com mobilidade reduzida	Personas de movilidad reducida	People with reduced mobility
	<b>CORES STANDARD:</b>	<b>COLORES STANDARD:</b>	<b>STANDARD COLORS:</b>
	Preto   Ardósia   Branco Ártico	Negro   Pizarra   Blanco Ártico	Black   Slate   Artic White

### NOTAS IMPORTANTES | NOTA IMPORTANTE | IMPORTANT NOTES:

Qualquer alteração de especificação dos produtos constantes da presente tabela de preços terá um agravamento de 10% aos preços indicados.

Cualquier cambio en la especificación de los productos enumerados en esta lista de precios dará lugar a un incremento de 10% en relación a los precios indicados.

Any change in the specification of the products listed in this price list will result in an increase of 10% in relation to the indicated prices.

A presente tabela de preços entra em vigor em Fevereiro 2022

Esta tarifa de precios entra en vigor en Febrero de 2022

This price list takes effect in February 2022



# simbologia

simbologia · symbology



#### Descarga eficaz c/ 2,5L/ 4L

Descarga efectiva c/ 2,5L/ 4L  
Effective discharge w/ 2,5L/ 4L



#### Descarga eficaz c/ 3L/ 5L

Descarga efectiva c/ 3L/ 5L  
Effective discharge w/ 3L/ 5L



#### Estruturas de bacia suspensa com 10 anos de garantia

Estructuras para inodoro suspenso con 10 años de garantía  
Concealed systems for wall - hung WC with 10 year warranty



#### Bacia c/ comprimento 60cm

Inodoro con longitud 60cm  
WC length 60cm



#### Resistência ao escorregamento

Resistencia a la resbaladad  
Resistance slip



#### Artigos cerâmico com 20 anos de garantia

Artículos cerámicos con 20 años de garantía  
Ceramic articles with 20 years warranty



#### Torneiras com 5 anos de garantia

Grifos con 5 años de garantía  
Taps with 5 years warranty



#### Tampo soft-close

Tapa soft-close  
Soft-close toilet seat

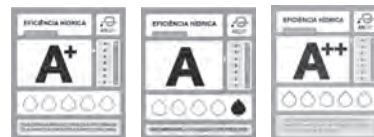

#### Certificação hídrica do autoclismo

Certificación hídrica  
Hydric certification toilet







# COLEÇÕES SANITÁRIAS

COLECCIONES SANITARIAS  
SANITARY COLLECTIONS



<b>EGG</b>	20
<b>NAUTILUS</b>	24
<b>ONE</b>	29
<b>TWO</b>	34
<b>LIGHT</b>	40
<b>NEOCLÁSSICA</b>	41
<b>100</b>	51
<b>OPUS</b>	55
<b>OCEANUS</b>	60





EGG



**BACIA COMPACTA**  
INODORO P/ TANQUE BAJO  
CLOSE COUPLED WC  
PAG 20

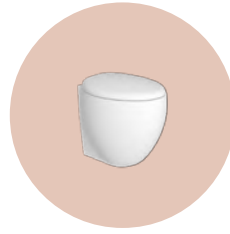

**BACIA NORMAL BTW**  
INODORO P/ TANQUE EMPOTRADO BTW  
WC CONCEALED BTW  
PAG 21

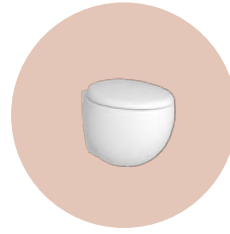

**BACIA SUSPENSA**  
INODORO SUSPENDIDO  
WALL-HUNG WC  
PAG 22

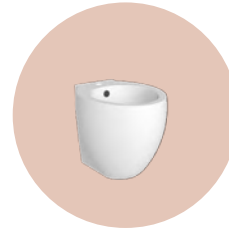

**BIDÉ**  
BIDÉ  
BIDET  
PAG 21

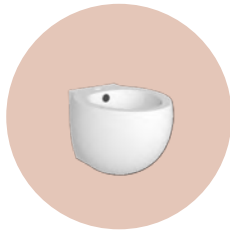

**BIDÉ SUSPENSO**  
BIDÉ SUSPENDIDO  
WALL-HUNG BIDET  
PAG 22



**LAVATÓRIO**  
LAVABO  
WASHBASIN  
PAG 20



**LAVATÓRIO SUSPENSO**  
LAVABO SUSPENDIDO  
WALL-HUNG WASHBASIN  
PAG 21

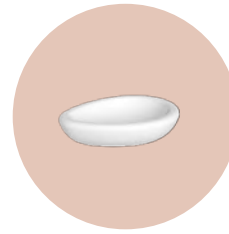

**LAVATÓRIO POUSAR**  
LAVABO SOBRE MUEBLE  
STANDING WASHBASIN  
PAG 20



NAUTILUS

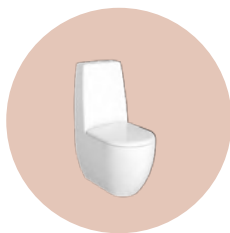

**BACIA COMPACTA**  
INODORO P/ TANQUE BAJO  
CLOSE COUPLED WC  
PAG 25

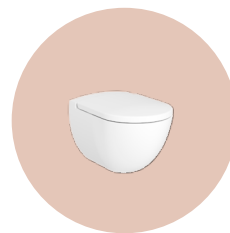

**BACIA SUSPENSA**  
INODORO SUSPENDIDO  
WALL-HUNG WC  
PAG 26

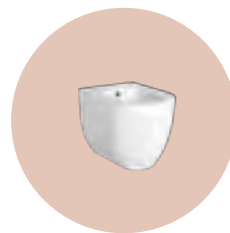

**BIDÉ**  
BIDÉ  
BIDET  
PAG 25



**BIDÉ SUSPENSO**  
BIDÉ SUSPENDIDO  
WALL-HUNG BIDET  
PAG 27



**LAVATÓRIO MÉDIO**  
LAVABO MÉDIO  
WASHBASIN MEDIUM  
PAG 24



**LAVATÓRIO SUSPENSO**  
LAVABO SUSPENDIDO  
WALL-HUNG WASHBASIN  
PAG 26



**LAVATÓRIO POUSAR**  
LAVABO SOBRE MUEBLE  
STANDING WASHBASIN  
PAG 24



ONE



**BACIA COMPACTA**  
INODORO P/ TANQUE BAJO  
CLOSE COUPLED WC  
PAG 30



**BACIA SUSPENSA**  
INODORO SUSPENDIDO  
WALL-HUNG WC  
PAG 31

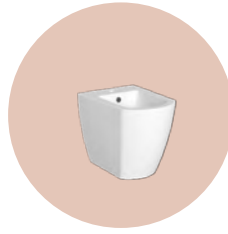

**BIDÉ**  
BIDÉ  
BIDET  
PAG 30



**BIDÉ SUSPENSO**  
BIDÉ SUSPENDIDO  
WALL-HUNG BIDET  
PAG 32

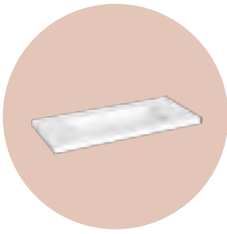

**LAVATÓRIO ONE LINE**  
LAVABO ONE LINE  
WASHBASIN ONE LINE  
PAG 29

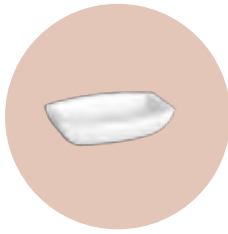

**LAVATÓRIO ONE BOLD**  
LAVABO ONE BOLD  
WASHBASIN ONE BOLD  
PAG 31

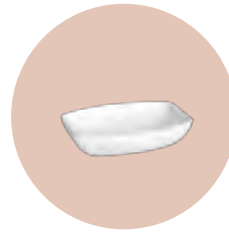

**LAVATÓRIO ONE SLIM**  
LAVABO ONE SLIM  
WASHBASIN ONE SLIM  
PAG 31

TWO



**BACIA COMPACTA**  
INODORO P/ TANQUE BAJO  
CLOSE COUPLED WC  
PAG 34

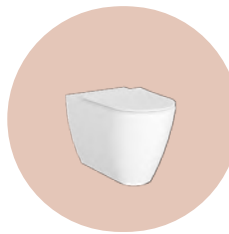

**BACIA NORMAL BTW**  
INODORO P/ TANQUE EMPOTRADO BTW  
WC CONCEALED BTW  
PAG 35

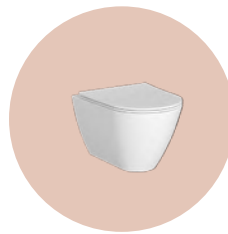

**BACIA SUSPENSA**  
INODORO SUSPENDIDO  
WALL-HUNG WC  
PAG 36

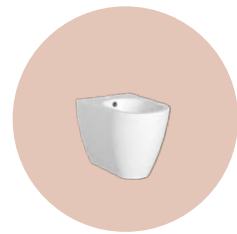

**BIDÉ**  
BIDÉ  
BIDET  
PAG 36

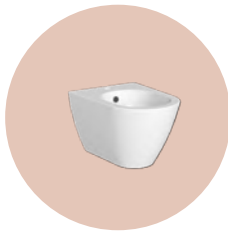

**BIDÉ SUSPENSO**  
BIDÉ SUSPENDIDO  
WALL-HUNG BIDET  
PAG 37





LIGHT



**BACIA SUSPensa**  
INODORO SUSPENDIDO  
WALL-HUNG WC  
PAG 40



**BIDÉ SUSPENS**  
BIDE SUSPENDIDO  
WALL-HUNG BIDET  
PAG 40

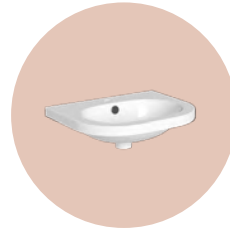

**LAVATÓRIO**  
LAVABO  
WASHBASIN  
PAG 40



NEOCLÁSSICA



**BACIA COMPACTA**  
INODORO P/ TANQUE BAJO  
CLOSE COUPLED WC  
PAG 42



**BACIA NORMAL BTW**  
INODORO P/ TANQUE EMPOTRADO BTW  
WC CONCEALED BTW  
PAG 46

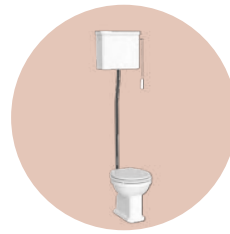

**BACIA NORMAL TANQUE ALTO**  
INODORO NORMAL TANQUE ALTO  
WC CONCEALED HIGH LEVEL CISTERN  
PAG 44



**BACIA NORMAL**  
INODORO P/ TANQUE EMPOTRADO  
WC CONCEALED  
PAG 44



**BACIA SUSPensa**  
INODORO SUSPENDIDO  
WALL-HUNG WC  
PAG 47

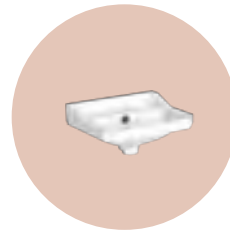

**LAVA MÃOS C/ ESPALDAR**  
LAVA-MANOS C/ COPETE  
HAND WASHBASIN W/ BACK SPLASH  
PAG 44



**LAVATÓRIO MÉDIO C/ ESPALDAR**  
LAVABO MEDIO C/ COPETE  
WASHBASIN MEDIUM W/ BACK SPLASH  
PAG 43

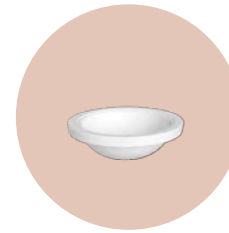

**LAVATÓRIO NEO EMBUTIR**  
LAVABO NEO SOBRE ENCIMERA  
EMBEDDED WASHBASIN NEO  
PAG 46



**LAVATÓRIO NORMAL/MÉDIO**  
LAVABO NORMAL/MEDIO  
WASHBASIN NORMAL/MEDIUM  
PAG 41

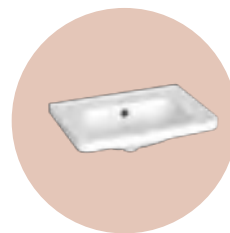

**LAVATÓRIO NEO RETANGULAR EMBUTIR**  
LAVABO SOBRE ENCIMERA NEO RETANGULAR  
EMBEDDED RECTANGULAR WASHBASIN NEO  
PAG 41

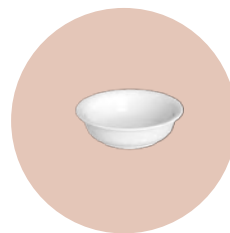

**LAVATÓRIO SERRAS**  
LAVABO SERRAS  
WASHBASIN SERRAS  
PAG 47



100



**BACIA COMPACTA**  
INODORO P/ TANQUE BAJO  
CLOSE COUPLED WC  
PAG 51



**BACIA SUSPENSÁ**  
INODORO SUSPENDIDO  
WALL-HUNG WC  
PAG 53



**BIDÉ**  
BIDÉ  
BIDET  
PAG 52

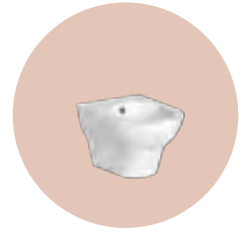

**BIDÉ SUSPENSO**  
BIDÉ SUSPENDIDO  
WALL-HUNG BIDET  
PAG 54

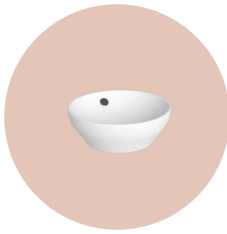

**LAVATÓRIO POUAR**  
LAVABO SOBRE MUEBLE  
STANDING WASHBASIN  
PAG 51

OPUS



**BACIA COMPACTA**  
INODORO P/ TANQUE BAJO  
CLOSE COUPLED WC  
PAG 55



**BACIA NORMAL**  
INODORO P/ TANQUE EMPOTRADO  
WC CONCEALED  
PAG 56



**BACIA SUSPENSÁ**  
INODORO SUSPENDIDO  
WALL-HUNG WC  
PAG 57



**BIDÉ**  
BIDÉ  
BIDET  
PAG 56



**BIDÉ BTW**  
BIDÉ BTW  
BIDET BTW  
PAG 56

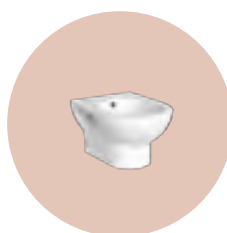

**BIDÉ SUSPENSO**  
BIDÉ SUSPENDIDO  
WALL-HUNG BIDET  
PAG 58



**LAVATÓRIO MÉDIO/JÚNIOR**  
LAVABO MÉDIO/JUNIOR  
WASHBASIN MEDIUM/JUNIOR  
PAG 55



**LAVATÓRIO SUSPENSO**  
LAVABO SUSPENDIDO  
WALL-HUNG WASHBASIN  
PAG 57





OCEANUS



**BACIA COMPACTA**  
INODORO P/ TANQUE BAJO  
CLOSE COUPLED WC  
PAG 60



**BACIA SUSPENSA**  
INODORO SUSPENDIDO  
WALL-HUNG WC  
PAG 62



**BACIA NORMAL**  
INODORO P/ TANQUE EMPOTRADO  
WC CONCEALED  
PAG 61



**BIDÉ**  
BIDÉ  
BIDET  
PAG 61



**LAV. NORMAL/MÉDIO/JÚNIOR**  
LAV. NORMAL/MEDIO/JUNIOR  
WASHBASIN NORMAL/MED./JUN.  
PAG 60



**LAVATÓRIO SUSPENSO**  
LAVABO SUSPENDIDO  
WALL-HUNG WASHBASIN  
PAG 62







**LAVATÓRIO POUSAR****REF**BRANCO  
BLANCO  
WHITECORES STANDARD  
COLORES STANDARD  
STANDARD COLORSCORES ESPECIAIS  
COLORES ESPECIALES  
SPECIAL COLORSLavabo sobre mueble  
Standing washbasin

XX=

00

23 / 47 / 48

PÁG. 8

(50x38x12 cm)

39357xx2C

168 €

295 €

336 €

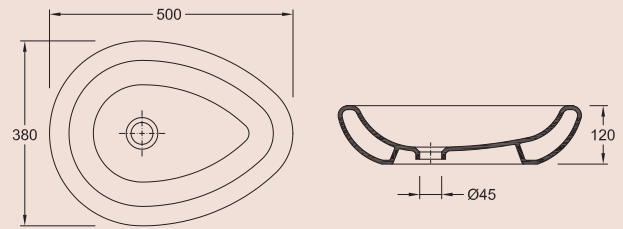
**LAVATÓRIO COLUNA INTEGRADA****REF**BRANCO  
BLANCO  
WHITECORES STANDARD  
COLORES STANDARD  
STANDARD COLORSCORES ESPECIAIS  
COLORES ESPECIALES  
SPECIAL COLORSLavabo columna  
Washbasin with integrated pedestal

XX=

00

23 / 47 / 48

PÁG. 8

(48x52x90 cm)

39881xx2C

1.025 €

1.794 €

2.050 €

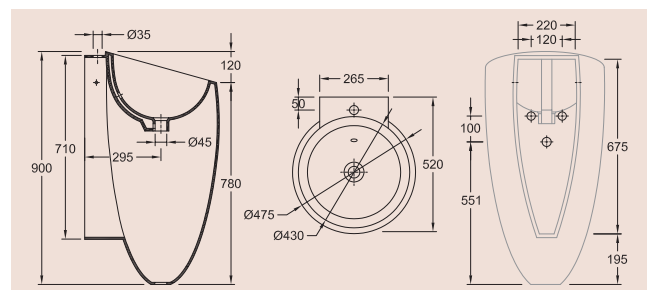
**BACIA COMPACTA V/H****REF**BRANCO  
BLANCO  
WHITECORES STANDARD  
COLORES STANDARD  
STANDARD COLORSCORES ESPECIAIS  
COLORES ESPECIALES  
SPECIAL COLORSInodoro p/ tanque baixo V/H  
Close coupled WC V/H

XX=

00

23 / 47 / 48

PÁG. 8

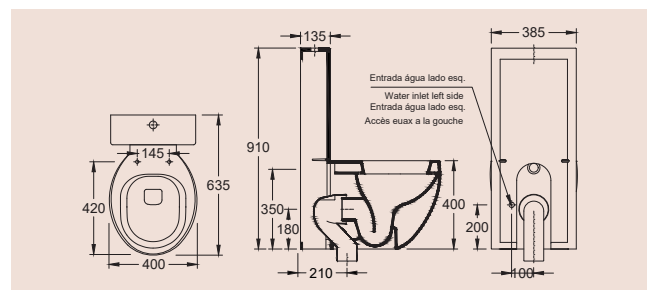

(50x40x40 cm)

39071xx2V

508 €

888 €

1.015 €

(50x40x40 cm)

39071xx2H

508 €

888 €

1.015 €

**TANQUE CERÂMICO C/  
MECANISMO**Tanque cerâmico con mecanismo  
Ceramic cistern with mechanism

(91x39x14 cm)

39142xx2K

400 €

700 €

799 €

BRANCO BLANCO WHITE	CORES STANDARD COLORES STANDARD STANDARD COLORS	CORES ESPECIAIS COLORES ESPECIALES SPECIAL COLORS	REF	BACIA NORMAL BTW V/H
XX= 00	23 / 47 / 48	PÁG. 8		Inodoro p/ tanque empotrado BTW V/H WC concealed BTW V/H (50x40x40 cm)
400 €	700 €	799 €	39071xx2K	
400 €	700 €	799 €	39071xx2W	(50x40x40 cm)

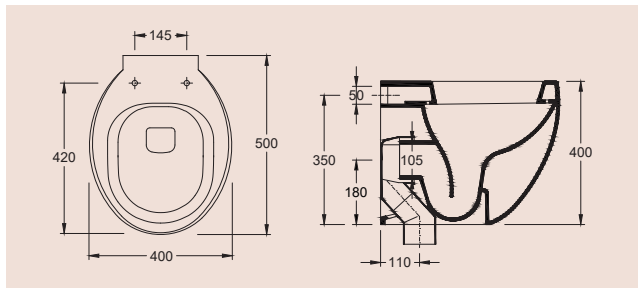

BRANCO BLANCO WHITE	CORES STANDARD COLORES STANDARD STANDARD COLORS	CORES ESPECIAIS COLORES ESPECIALES SPECIAL COLORS	REF	TAMPO SC TAKE-OFF
XX= 00	23 / 47 / 48	PÁG. 8		Tapa SC take-off Toilet seat SC take-off
125 €	218 €	249 €	50264xx5	

BRANCO BLANCO WHITE	CORES STANDARD COLORES STANDARD STANDARD COLORS	CORES ESPECIAIS COLORES ESPECIALES SPECIAL COLORS	REF	BIDÉ
00	23 / 47 / 48	PÁG. 8		Bidé Bidet
348 €	609 €	695 €	39411xx2K	(50x40x40cm)

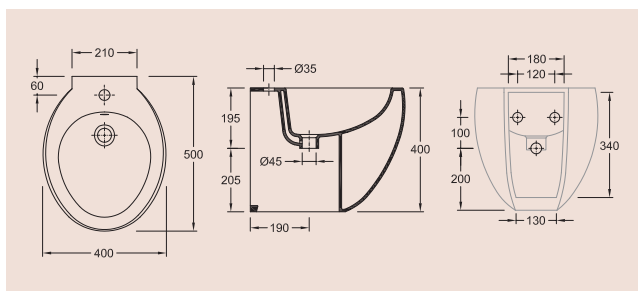

BRANCO BLANCO WHITE	CORES STANDARD COLORES STANDARD STANDARD COLORS	CORES ESPECIAIS COLORES ESPECIALES SPECIAL COLORS	REF	LAVATÓRIO SUSPENSO COLUNA INTEGRADA
00	23 / 47 / 48	PÁG. 8		Lavabo columna suspendido Wall hung washbasin with integrated pedestal
286 €	500 €	571 €	39871xx2K	(35x34x59 cm)

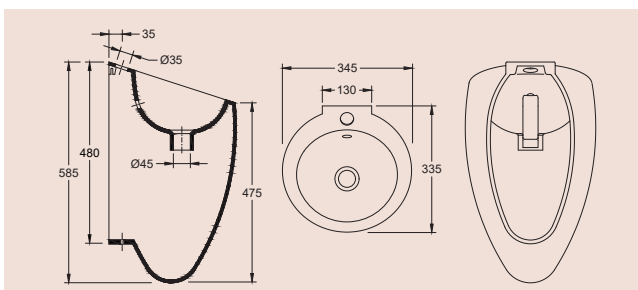

**MONOCOMANDO DE LAVATÓRIO EGG SUSPENSO**

Monomando de lavabo EGG suspenso  
Single lever washbasin mixer EGG washbasin

**REF**  
5061532x

CROMADO CROMO CHROME	NIQUEL ESCOVADO NIQUEL PULIDO BRUSHED NICKEL	PRETO MATE NEGRO MATE BLACK MATT
X= 2	0	3
151 €	227 €	227 €

**BACIA SUSPENSA**

Inodoro suspenso Wall-hung WC  
(50x40x33 cm)

**REF**  
39001xx2K

BRANCO BLANCO WHITE	CORES STANDARD COLORES STANDARD STANDARD COLORS	CORES ESPECIAIS COLORES ESPECIALES SPECIAL COLORS
XX= 00	23 / 47 / 48	PÁG. 8
379 €	663 €	757 €

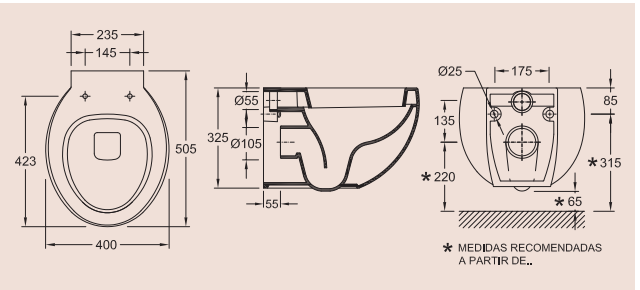

**TAMPO SC TAKE-OFF**

Tapa SC take-off Toilet seat SC take-off

**REF**  
50268xx5

BRANCO BLANCO WHITE	CORES STANDARD COLORES STANDARD STANDARD COLORS	CORES ESPECIAIS COLORES ESPECIALES SPECIAL COLORS
XX= 00	23 / 47 / 48	PÁG. 8
125 €	218 €	249 €

**BIDÉ SUSPENSO**

Bidé Suspenso Wall-hung bidet

(50x40x33 cm)

**REF**  
39401xx2K

BRANCO BLANCO WHITE	CORES STANDARD COLORES STANDARD STANDARD COLORS	CORES ESPECIAIS COLORES ESPECIALES SPECIAL COLORS
XX= 00	23 / 47 / 48	PÁG. 8
314 €	550 €	628 €

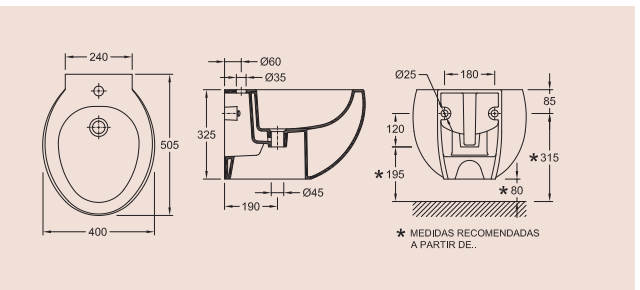



	<b>REF</b>	<b>JUNTA ANTI-RUÍDO P/ BACIA SUSPensa (ARTIGO OPCIONAL)</b>
13 €	55034601	Junta anti ruido para inodoro suspendido (artículo opcional) Anti-noise joint for wall hung WC (optional article)
	<b>REF</b>	<b>PULSADOR CROMADO P/ MECANISMO</b>
10 €	55094000	Pulsador cromo p/ mecanismo Chromed pushbutton for mechanism
	<b>REF</b>	<b>KIT DE FIXAÇÃO LATERAL</b>
7 €	55185000	Kit de fijación lateral Side fixing kit
	<b>REF</b>	<b>SUPORE DE FIXAÇÃO (LAVATÓRIO SUSPENSO)</b>
13 €	55150210	Soporte de fijación (lavabo suspendido) Fixing bracket (wall hung washbasin)
	<b>REF</b>	<b>CURVA DE DESCARGA VERTICAL (BACIA COMPACTA)</b>
21 €	55114030	Curva de descarga vertical (inodoro compacto) Vertical discharge curve (close coupled WC)
	<b>REF</b>	<b>CURVA DE DESCARGA VERTICAL (BACIA BTW)</b>
21 €	55114011	Manguito de descarga vertical (inodoro BTW) Vertical discharge curve (BTW WC)
	<b>REF</b>	<b>TUBO DE DESCARGA HORIZONTAL 30CM (BACIA COMPACTA)</b>
26 €	55023031	Tubo de descarga horizontal 30cm (inodoro compacto) Horizontal discharge tube 30cm (close coupled WC)
	<b>REF</b>	<b>TUBO DE DESCARGA HORIZONTAL 25CM (BACIA BTW)</b>
21 €	55040010	Tubo de descarga horizontal 25cm (inodoro BTW) Horizontal discharge tube 25cm (BTW WC)
	<b>REF</b>	<b>KIT DE FIXAÇÃO POSTERIOR (BACIA COMPACTA)</b>
46 €	55150180	Kit de fijación trasera (inodoro compacto) Rear fixation kit (close coupled WC)
	<b>REF</b>	<b>KIT DE FIXAÇÃO POSTERIOR (BACIA BTW)</b>
46 €	55150190	Kit de fijación trasera (inodoro BTW) Rear fixation kit (BTW WC)
	<b>REF</b>	<b>KIT FIXAÇÃO (BACIA E BIDÉ SUSPENSOS EGG)</b>
32 €	55150200	Kit de fijación (inodoro y bidé suspendidos Egg) Fixing kit (Egg wall-hung WC and bidet)
	<b>REF</b>	<b>TANQUE PLÁSTICO C/ MECANISMO DD</b>
86 €	50564011	Tanque plástico c/ mecanismo DD Plastic cistern w/ mechanism DD

**LAVATÓRIO POUSAR**

**REF**

Lavabo sobre mueble  
Standing washbasin  
(51x51x14 cm)

34351xx2C

BRANCO BLANCO WHITE	CORES STANDARD COLORES STANDARD STANDARD COLORS	CORES ESPECIAIS COLORES ESPECIALES SPECIAL COLORS
XX= 00	23 / 47 / 48	PÁG. 8
164 €	287 €	327 €

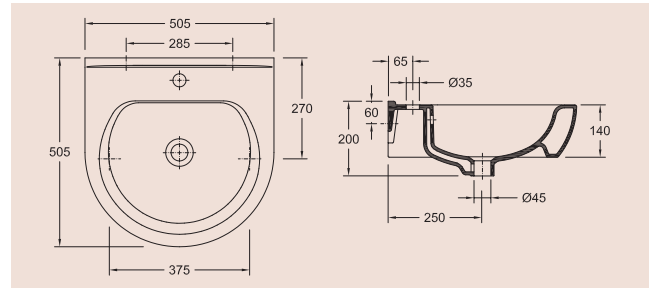

**LAVATÓRIO MÉDIO**

**REF**

Lavabo médio  
Washbasin medium



(51x51x20 cm)

34331xx2C

BRANCO BLANCO WHITE	CORES STANDARD COLORES STANDARD STANDARD COLORS	CORES ESPECIAIS COLORES ESPECIALES SPECIAL COLORS
XX= 00	23 / 47 / 48	PÁG. 8
190 €	333 €	380 €

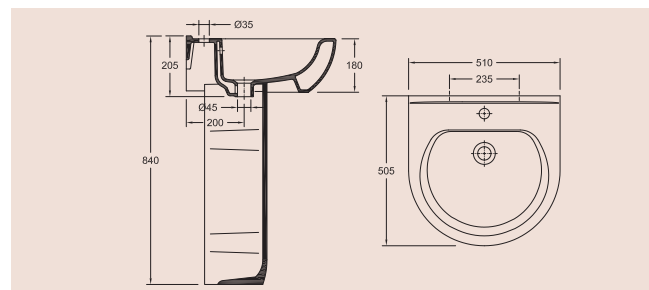

**COLUNA**

Columna  
Pedestal

34200xx2K

126 €	220 €	251 €
-------	-------	-------

BRANCO  
BLANCO  
WHITE

CORES STANDARD  
COLORES STANDARD  
STANDARD COLORS

CORES ESPECIAIS  
COLORES ESPECIALES  
SPECIAL COLORS

REF

**BACIA COMPACTA HIDE RIMLESS V/H**

XX= 00

23 / 47 / 48

PÁG. 8

Inodoro Rimless p/ T.Bajo Hide V/H  
Close coupled Rimless Hide WC V/H

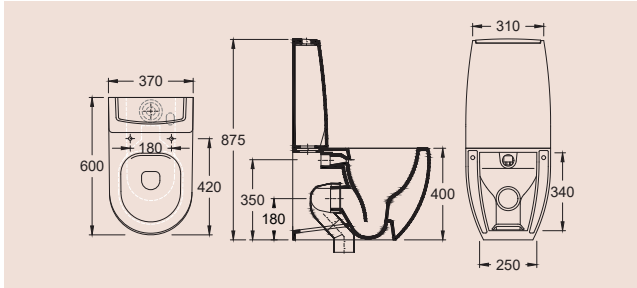

357 €

625 €

713 €

34554xx2V

(60x37x40 cm)

357 €

625 €

713 €

34554xx2H

(60x37x40 cm)

**TANQUE CERÂMICO C/ MECANISMO**

Tanque cerâmico con mecanismo  
Ceramic cistern with mechanism

173 €

268 €

299 €

34192xx2K

(37x15x40 cm)

BRANCO  
BLANCO  
WHITE

CORES STANDARD  
COLORES STANDARD  
STANDARD COLORS

CORES ESPECIAIS  
COLORES ESPECIALES  
SPECIAL COLORS

REF

**TAMPO TERMODUR SC TAKE-OFF**

XX= 00

23 / 47 / 48

PÁG. 8

Tapa termodur SC take-off  
Toilet seat SC take-off

82 €

143 €

163 €

50212xx0

**TAMPO TERMODUR TAKE-OFF**

Tapa termodur take-off  
Toilet seat take-off

63 €

111 €

125 €

50213xx0

BRANCO  
BLANCO  
WHITE

CORES STANDARD  
COLORES STANDARD  
STANDARD COLORS

CORES ESPECIAIS  
COLORES ESPECIALES  
SPECIAL COLORS

REF

**BIDÉ HIDE**

XX= 00

23 / 47 / 48

PÁG. 8

Bidé Hide  
Bidet Hide

242 €

424 €

483 €

34414xx2K

(56x37x40 cm)

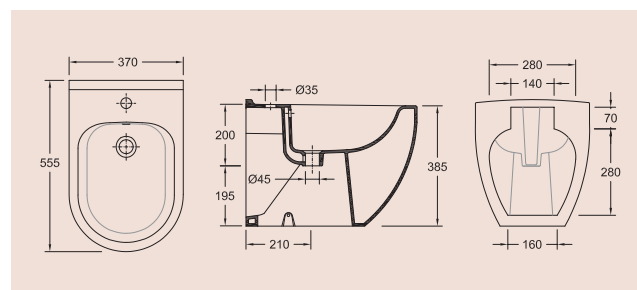

**LAVATÓRIO MÉDIO SUSPENSO**

REF

BRANCO  
BLANCO  
WHITE

CORES STANDARD  
COLORES STANDARD  
STANDARD COLORS

CORES ESPECIAIS  
COLORES ESPECIALES  
SPECIAL COLORS

Lavabo médio suspenso  
Wall-hung washbasin medium

00

23 / 47 / 48

PÁG. 8

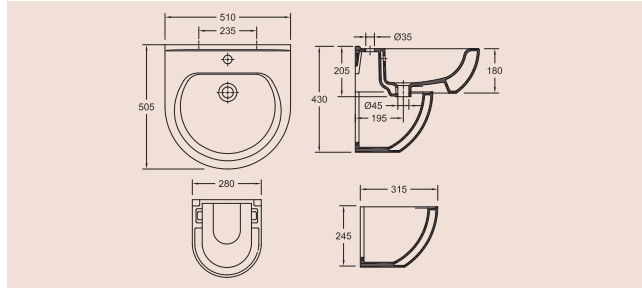

(51x51x20 cm)

34331xx2C

190 €

333 €

380 €

**COLUNA SUSPENSA**

Columna suspendida  
Wall-hung pedestal

34220xx2K

121 €

212 €

242 €

**BACIA SUSPENSA HIDE**

REF

BRANCO  
BLANCO  
WHITE

CORES STANDARD  
COLORES STANDARD  
STANDARD COLORS

CORES ESPECIAIS  
COLORES ESPECIALES  
SPECIAL COLORS

Inodoro suspenso hide  
Wall-hung Hide WC

00

23 / 47 / 48

PÁG. 8

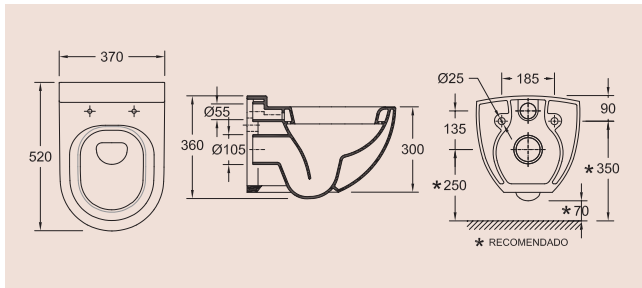

(52x37x36 cm)

34004xx2K

299 €

524 €

598 €

**BACIA SUSPENSA HIDE RIMLESS**

Inodoro suspenso hide Rimless  
Wall-hung Rimless hide WC

(52x37x36 cm)

34504xx2K

322 €

564 €

644 €

**TAMPO TERMODUR SC TAKE-OFF**

REF

BRANCO  
BLANCO  
WHITE

CORES STANDARD  
COLORES STANDARD  
STANDARD COLORS

CORES ESPECIAIS  
COLORES ESPECIALES  
SPECIAL COLORS

Tapa termodur SC take-off  
Toilet seat SC take-off

XX= 00

23 / 47 / 48

PÁG. 8

50239xx0

82 €

143 €

163 €

**TAMPO TERMODUR TAKE-OFF**

Tapa termodur take-off  
Toilet seat take-off

50235xx0

63 €

111 €

125 €



BRANCO BLANCO WHITE	CORES STANDARD COLORES <b>STANDARD</b> STANDARD COLORS	CORES ESPECIAIS COLORES <b>ESPECIALES</b> SPECIAL COLORS	REF	BIDÉ SUSPENSO HIDE
XX= 00	23 / 47 / 48	PÁG. 8		Bidé suspenso hide Wall-hung Hide bidet (52x38x32 cm)
242 €	424 €	483 €	34404xx2K	

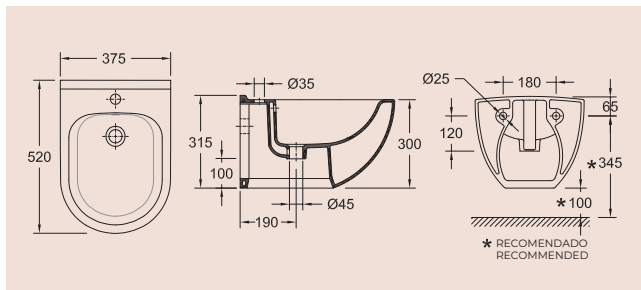



**JUNTA ANTI-RUÍDO P/ BACIA SUSPensa (ARTIGO OPCIONAL)**

REF

Junta anti ruido para inodoro suspendido (artículo opcional)  
Anti-noise joint for wall-hung WC (optional article)

55034602

13 €

**PULSADOR CROMADO P/ MECANISMO**

REF

Pulsador cromo p/ mecanismo  
Chromed pushbutton for mechanism

55094000

10 €

**KIT FIXAÇÃO (LAVATÓRIO MÉDIO)**

REF

Kit de fijación (lavabo médio)  
Fixing kit (medium washbasin)

55007001

5 €

**KIT FIXAÇÃO (COLUNA SUSPensa)**

REF

Kit de fijación (columna suspendida)  
Fixing kit (wall-hung column)

55126010

22 €

**KIT FIXAÇÃO LATERAL**

REF

Kit de fijación lateral  
Side fixing kit

55185010

9 €

**CURVA DE DESCARGA VERTICAL (BACIA COMPACTA)**

REF

Curva de descarga vertical (inodoro compacto)  
Vertical discharge curve (close coupled WC)

55114030

21 €

**TUBO DE DESCARGA HORIZONTAL (BACIA COMPACTA)**

REF

Tubo de descarga horizontal (inodoro compacto)  
Horizontal discharge tube (close coupled WC)

55040010

21 €

**KIT DE RETENÇÃO (TANQUE)**

REF

Kit de retención (tanque)  
Retention kit (cistern)

55150023

14 €

**TUBO FLEXÍVEL (TANQUE)**

REF

Tubo flexible (tanque)  
Flexible pipe (cistern)

55150031

10 €

**VÁLVULA DE CORTE (TANQUE)**

REF

Válvula de cierre (tanque)  
Shutoff valve (cistern)

50679001

18 €

**KIT FIXAÇÃO BACIA SUSPensa**

REF

Kit de fijación para inodoro suspendido  
Wall-hung toilet fixing kit

55150202

22 €

**KIT FIXAÇÃO BIDÉ SUSPENSO**

REF

Kit de fijación para bidé suspendido  
Wall-hung bidet fixing kit

55150204

22 €

**MECANISMO DD**

REF

Mecanismo DD  
Mechanism DD

50592042

51 €

BRANCO  
BLANCO  
WHITE

CORES STANDARD  
COLORES STANDARD  
STANDARD COLORS

CORES ESPECIAIS  
COLORES ESPECIALES  
SPECIAL COLORS

REF

LAVATÓRIO ONE LINE

XX= 00

23 / 47 / 48

PÁG. 8

Lavabo ONE LINE  
Washbasin ONE LINE

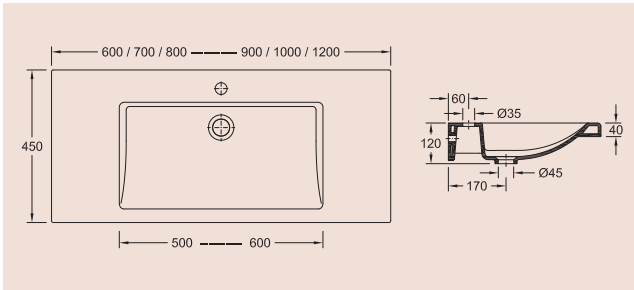

366 €	641 €	732 €	40331xx2C	120 (120x45x12 cm)
290 €	508 €	580 €	40321xx2C	100 (100x45x12 cm)
257 €	450 €	514 €	40361xx2C	90 (90x45x12 cm)
228 €	400 €	456 €	40311xx2C	80 (80x45x12 cm)
203 €	356 €	406 €	40341xx2C	70 (70x45x12 cm)
178 €	311 €	355 €	40301xx2C	60 (60x45x12 cm)

INOX POLIDO  
ACERO INOXIDABLE PULIDO  
POLISHED STAINLESS STEEL

PRETO  
NEGRO  
BLACK

REF

TOALHEIRO ONE LINE

x = 0

x = 3

Toallero ONE LINE  
Towel rail ONE LINE

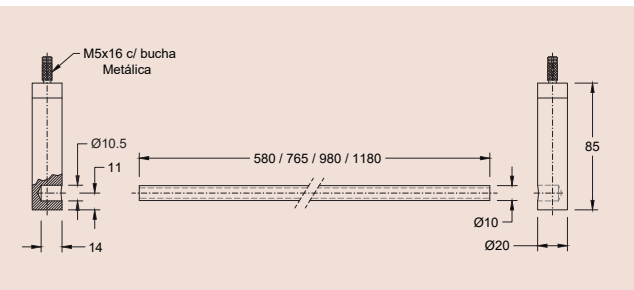

80 €	120 €	5517414x	120
73 €	110 €	5517413x	100
73 €	110 €	5517405x	90
67 €	101 €	5517408x	80
67 €	101 €	5517402x	70
67 €	101 €	5517407x	60





**BACIA COMPACTA V/H**

REF

BRANCO  
BLANCO  
WHITE

CORES STANDARD  
COLORES STANDARD  
STANDARD COLORS

CORES ESPECIAIS  
COLORES ESPECIALES  
SPECIAL COLORS

Inodoro para tanque baixo V/H  
Close coupled WC V/H

XX= 00 23 / 47 / 48 PÁG. 8

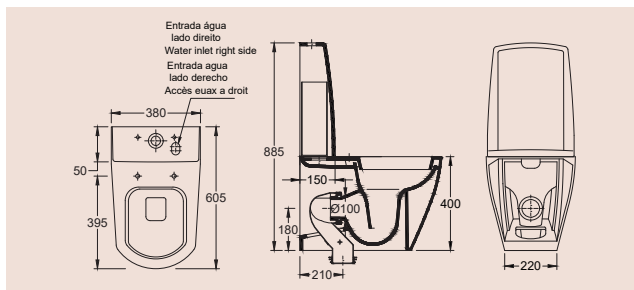

(60x38x40 cm)

40051xx2V

309 €

540 €

617 €

(60x38x40 cm)

40051xx2H

309 €

540 €

617 €

**TANQUE CERÂMICO C/ MECANISMO**

Tanque cerâmico con mecanismo  
Ceramic cistern with mechanism

(38x15x41 cm)

40182xx2K

193 €

283 €

313 €

**TAMPO TERMODUR SC TAKE-OFF**

REF

BRANCO  
BLANCO  
WHITE

CORES STANDARD  
COLORES STANDARD  
STANDARD COLORS

CORES ESPECIAIS  
COLORES ESPECIALES  
SPECIAL COLORS

Tapa termodur SC take-off  
Toilet seat SC take-off

XX= 00 23 / 47 / 48 PÁG. 8

50202xx0

76 €

134 €

152 €

**TAMPO TERMODUR TAKE-OFF**

Tapa termodur take-off  
Toilet seat take-off

50203xx0

60 €

105 €

120 €

**BIDÉ**

REF

BRANCO  
BLANCO  
WHITE

CORES STANDARD  
COLORES STANDARD  
STANDARD COLORS

CORES ESPECIAIS  
COLORES ESPECIALES  
SPECIAL COLORS

Bidé  
Bidet

XX= 00 23 / 47 / 48 PÁG. 8

(50x36x40 cm)

40411xx2K

221 €

387 €

442 €

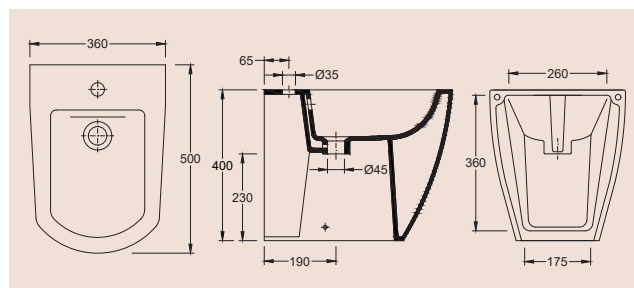

BRANCO BLANCO WHITE	CORES STANDARD COLORES STANDARD STANDARD COLORS	CORES ESPECIAIS COLORES ESPECIALES SPECIAL COLORS	REF	LAVATÓRIO BOLD
---------------------------	---	---	-----	----------------

XX= 00 23 / 47 / 48 PÁG. 8

179 €	313 €	357 €
-------	-------	-------

40350xx2C

Lavabo Bold  
Washbasin Bold  
(51x39x13 cm)

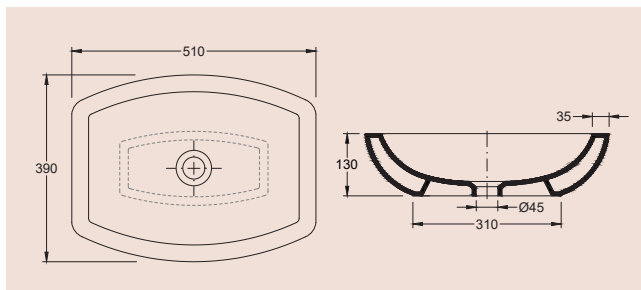

BRANCO BLANCO WHITE	CORES STANDARD COLORES STANDARD STANDARD COLORS	CORES ESPECIAIS COLORES ESPECIALES SPECIAL COLORS	REF	LAVATÓRIO SLIM
---------------------------	---	---	-----	----------------

XX= 00 23 / 47 / 48 PÁG. 8

179 €	313 €	357 €
-------	-------	-------

40357xx2C

Lavabo Slim  
Washbasin Slim  
(47x35x13 cm)

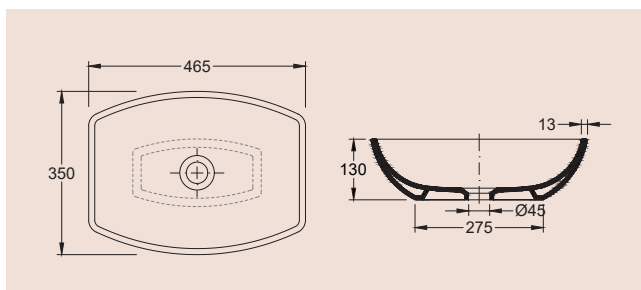

BRANCO BLANCO WHITE	CORES STANDARD COLORES STANDARD STANDARD COLORS	CORES ESPECIAIS COLORES ESPECIALES SPECIAL COLORS	REF	BACIA SUSPENSA
---------------------------	---	---	-----	----------------

XX= 00 23 / 47 / 48 PÁG. 8

262 €	458 €	523 €
-------	-------	-------

40001xx2K

Inodoro suspenso  
Wall-hung WC  
(50x38x33 cm)

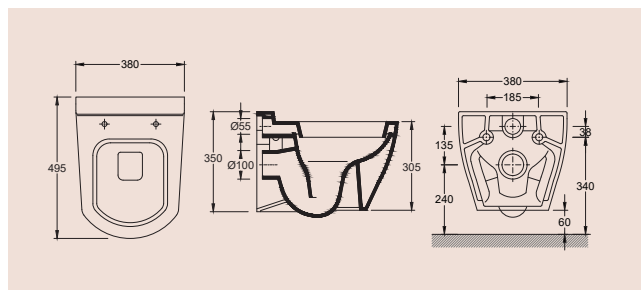

**TAMPO TERMODUR SC TAKE-OFF**

**REF**

BRANCO  
BLANCO  
WHITE

CORES STANDARD  
COLORES STANDARD  
STANDARD COLORS

CORES ESPECIAIS  
COLORES ESPECIALES  
SPECIAL COLORS

Tapa termodur SC take-off  
Toilet seat SC take-off

XX=

00

23 / 47 / 48

PÁG. 8

50202xx0

76 €

134 €

152 €

**TAMPO TERMODUR TAKE-OFF**

Tapa termodur take-off  
Toilet seat take-off

50203xx0

60 €

105 €

120 €

**BIDÉ SUSPENSO**

**REF**

BRANCO  
BLANCO  
WHITE

CORES STANDARD  
COLORES STANDARD  
STANDARD COLORS

CORES ESPECIAIS  
COLORES ESPECIALES  
SPECIAL COLORS

Bidé suspenso  
Wall-hung bidet

XX=

00

23 / 47 / 48

PÁG. 8

(50x36x30 cm)

40401xx2K

212 €

371 €

424 €

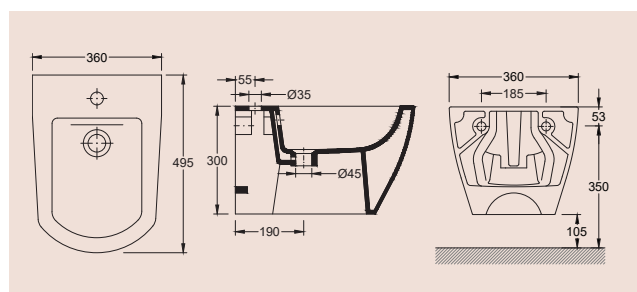



	<b>REF</b>	<b>JUNTA ANTI-RUÍDO P/ BACIA SUSPENSA (ARTIGO OPCIONAL)</b>
13 €	55034603	Junta anti ruido para inodoro suspendido (artículo opcional) Anti-noise joint for wall-hung WC (optional article)
	<b>REF</b>	<b>PULSADOR CROMADO P/ MECANISMO ONE</b>
10 €	55094000	Pulsador cromo p/ mecanismo ONE Chromed pushbutton for mechanism ONE
	<b>REF</b>	<b>KIT FIXAÇÃO (LAVATÓRIOS ONE LINE)</b>
5 €	55007001	Kit de fijación (lavabos ONE Line) Fixing kit (ONE Line washbasins)
	<b>REF</b>	<b>KIT FIXAÇÃO (LAVATÓRIO ONE LINE 80)</b>
5 €	55007320	Kit de fijación (lavabo ONE Line 80) Fixing kit (ONE Line 80 washbasin)
	<b>REF</b>	<b>KIT FIXAÇÃO LATERAL</b>
9 €	55185030	Kit de fijación lateral Side fixing kit
	<b>REF</b>	<b>CURVA DE DESCARGA VERTICAL (BACIA COMPACTA)</b>
21 €	55114030	Curva de descarga vertical (inodoro compacta) Vertical discharge curve (close coupled WC)
	<b>REF</b>	<b>TUBO DE DESCARGA HORIZONTAL 25CM (BACIA COMPACTA)</b>
21 €	55040010	Tubo de descarga horizontal 25cm (inodoro compacta) Horizontal discharge tube 25cm (close coupled WC)
	<b>REF</b>	<b>KIT DE RETENÇÃO (TANQUE)</b>
14 €	55150021	Kit de retención (tanque) Retention kit (cistern)
	<b>REF</b>	<b>TUBO FLEXÍVEL (TANQUE PLÁSTICO)</b>
10 €	55150031	Tubo flexible (tanque plástico) Flexible pipe (plastic cistern)
	<b>REF</b>	<b>VÁLVULA DE CORTE (TANQUE PLÁSTICO)</b>
18 €	50679001	Válvula de cierre (tanque plástico) Shutoff valve (plastic cistern)
	<b>REF</b>	<b>KIT FIXAÇÃO BACIA SUSPENSA</b>
22 €	55150202	Kit de fijación para inodoro suspendido Wall-hung toilet fixing kit
	<b>REF</b>	<b>KIT FIXAÇÃO BIDÉ SUSPENSO</b>
22 €	55150204	Kit de fijación para bidet suspendido Wall-hung bidet fixing kit
	<b>REF</b>	<b>TANQUE PLÁSTICO C/ MECANISMO DD</b>
78 €	50542031	Tanque plástico c/ mecanismo DD Plastic cistern w/ Mechanism DD

**BACIA COMPACTA V/H**

REF

BRANCO  
BLANCO  
WHITE

CORES STANDARD  
COLORES STANDARD  
STANDARD COLORS

Inodoro para tanque baixo V/H  
Close coupled WC V/H

XX= 00 23 / 47 / 48

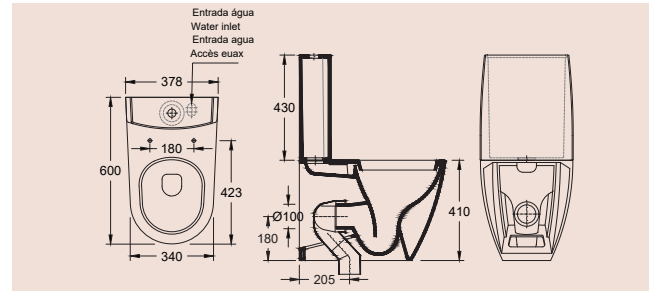

(60x38x41 cm)

41051xx2V

232 €

405 €

(60x38x33 cm)

41051xx2H

232 €

405 €

**TANQUE ALIMENTAÇÃO INFERIOR  
C/ MECANISMO**

Tanque alimentación inferior  
con mecanismo  
Bottom inlet cistern with mechanism

(38x13x43 cm)

41182xx2K

137 €

219 €

**TAMPO TERMODUR SLIM SC TAKE-OFF**

REF

BRANCO  
BLANCO  
WHITE

CORES STANDARD  
COLORES STANDARD  
STANDARD COLORS

Tapa termodur slim SC take-off  
Toilet seat slim SC take-off

XX= 00 23 / 47 / 48



50204xx0

80 €

138 €

**TAMPO TERMODUR SLIM TAKE-OFF**

Tapa termodur slim take-off  
Toilet seat slim take-off

50205xx0

56 €

97 €



BRANCO  
BLANCO  
WHITE

CORES STANDARD  
COLORES STANDARD  
STANDARD COLORS

REF

**TAMPO TERMODUR SC TAKE-OFF**

XX= 00

23 / 47 / 48

Tapa termodur SC take-off  
Toilet seat SC take-off



80€

138 €

50210xx0



**TAMPO TERMODUR TAKE-OFF**

56 €

97 €

50211xx0

Tapa termodur take-off  
Toilet seat take-off



BRANCO  
BLANCO  
WHITE

CORES STANDARD  
COLORES STANDARD  
STANDARD COLORS

REF

**BACIA NORMAL BTW RIMLESS V/H**

XX= 00

23 / 47 / 48

Inodoro Rimless BTW p/ t. empotrado V/H  
Normal Rimless BTW WC V/H

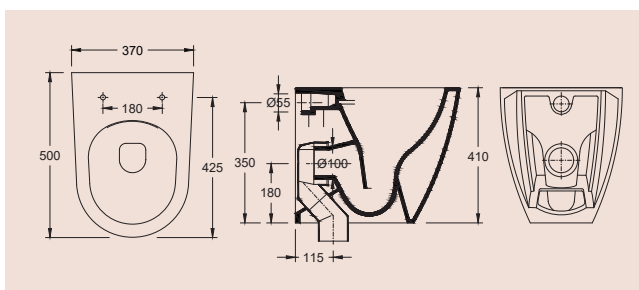

214 €

375 €

41541xx2V

(50x37x41 cm)



214 €

375 €

41541xx2H

(50x37x41cm)



**BIDÉ**

REF

BRANCO  
BLANCO  
WHITE

CORES STANDARD  
COLORES STANDARD  
STANDARD COLORS

Bidé  
Bidet

XX= 00

23 / 47 / 48

(50x37x41 cm)

41411xx2K

167 €

293 €

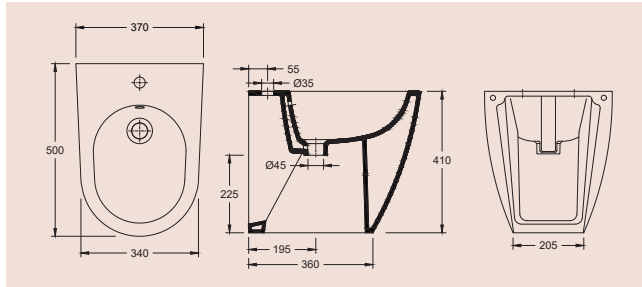

**BACIA SUSPensa**

REF

BRANCO  
BLANCO  
WHITE

CORES STANDARD  
COLORES STANDARD  
STANDARD COLORS

Inodoro suspenso  
Wall-hung WC

XX= 00

23 / 47 / 48

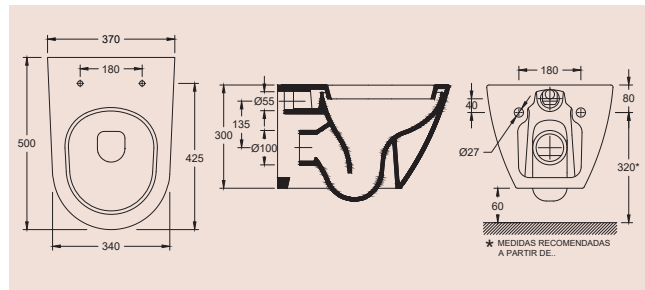

(50x37x30 cm)

41001xx2K

167 €

293 €

**BACIA SUSPensa RIMLESS**

Inodoro suspenso rimless  
Wall-hung WC rimless

41501xx2K

179 €

313 €

**TAMPO TERMODUR SLIM SC TAKE-OFF** REF

BRANCO  
BLANCO  
WHITE

CORES STANDARD  
COLORES STANDARD  
STANDARD COLORS

Tapa termodur slim SC take-off  
Toilet seat slim SC take-off

XX= 00

23 / 47 / 48



50204xx0

80 €

138 €

**TAMPO TERMODUR SLIM TAKE-OFF**

Tapa termodur slim take-off  
Toilet seat slim take-off

50205xx0

56 €

97 €

BRANCO BLANCO WHITE	CORES STANDARD COLORES STANDARD STANDARD COLORS	REF	TAMPO TERMODUR SC TAKE-OFF
---------------------------	---	-----	----------------------------

XX= 00 23 / 47 / 48

Tapa termodur SC take-off  
Toilet seat SC take-off



80 € 138 €

50210xx0



56 € 97 €

50211xx0

**TAMPO TERMODUR TAKE-OFF**

Tapa termodur take-off  
Toilet seat take-off



BRANCO BLANCO WHITE	CORES STANDARD COLORES STANDARD STANDARD COLORS	REF	BIDÉ SUSPENSO
---------------------------	---	-----	---------------

XX= 00 23 / 47 / 48

Bidé suspenso  
Wall-hung bidet



143 € 250 €

41401xx2K

(50x37x30 cm)

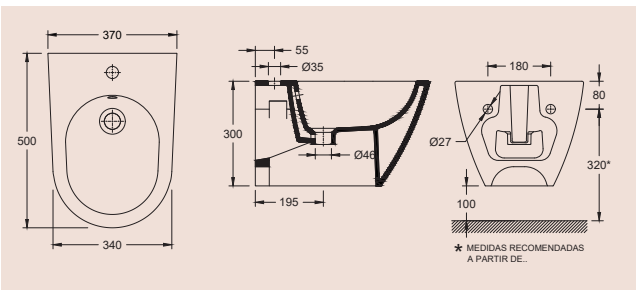

**JUNTA ANTI-RUÍDO P/ BACIA SUSPensa  
(ARTIGO OPCIONAL)**

REF

Junta anti ruido para inodoro suspendido  
(artículo opcional)  
Anti-noise joint for wall hung WC  
(optional article)

55034600

13 €

**MECANISMO DD**

REF

Mecanismo DD  
Mechanism DD

55519020

32 €

**KIT FIXAÇÃO LATERAL**

REF

Kit de fijación lateral  
Side fixing kit

55185030

9 €

**CURVA DE DESCARGA VERTICAL  
(BACIA COMPACTA)**

REF

Curva de descarga vertical (inodoro  
compacta)  
Vertical discharge curve (close coupled  
WC)

55114030

21 €

**CURVA DE DESCARGA VERTICAL  
(BACIA BTW)**

REF

Curva de descarga vertical (inodoro  
BTW)  
Vertical discharge curve (BTW WC)

55114011

21 €

**TUBO DE DESCARGA HORIZONTAL 25CM  
(BACIA COMPACTA)**

REF

Tubo de descarga horizontal 25cm (inodoro com-  
pacta)  
Horizontal discharge tube 25cm (close coupled WC)

55040010

21 €

**KIT DE RETENÇÃO (TANQUE)**

REF

Kit de retención (tanque)  
Retention kit (cistern)

55150023

14 €

**TUBO FLEXÍVEL (TANQUE)**

REF

Tubo flexible (tanque)  
Flexible pipe (cistern)

55150031

10 €

**VÁLVULA DE CORTE (TANQUE)**

REF

Válvula de cierre (tanque)  
Shutoff valve (cistern)

50679001

18 €



REF

**KIT FIXAÇÃO BACIA SUSPENSA**

22 €

55150202

Kit de fijación para inodoro suspendido  
Wall-hung toilet fixing kit

REF

**KIT FIXAÇÃO BIDÉ SUSPENSO**

22 €

55150204

Kit de fijación para bidé suspendido  
Wall-hung bidet fixing kit

REF

**EMBOQUE (BACIA SUSPENSA RIMLESS)**

6 €

55005030

Conexión (inodoro suspendido rimless)  
Rubber connection (wall-hung rimless WC)

REF

**REDUTOR DE CAUDAL  
(BACIA SUSPENSA RIMLESS)**

6 €

50649020

Reductor de flujo (inodoro suspendido  
rimless)  
Flow reducer (wall-hung rimless WC)



**LAVATÓRIO MÉDIO**

REF

BRANCO  
BLANCO  
WHITE

CORES STANDARD  
COLORES STANDARD  
STANDARD COLORS

CORES ESPECIAIS  
COLORES ESPECIALES  
SPECIAL COLORS

Lavabo médio  
Washbasin medium

XX=

00

23 / 47 / 48

PÁG. 8

(55x45x18 cm)

36331xx2C

140 €

244 €

279 €

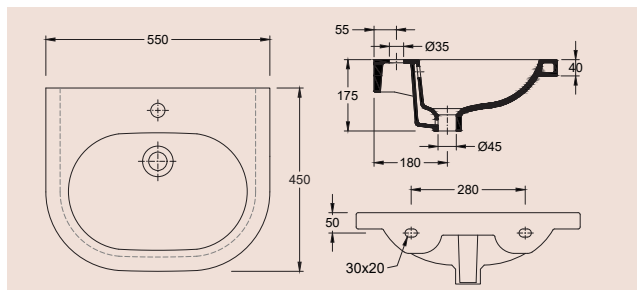

**BACIA SUSPENSA**

REF

BRANCO  
BLANCO  
WHITE

CORES STANDARD  
COLORES STANDARD  
STANDARD COLORS

CORES ESPECIAIS  
COLORES ESPECIALES  
SPECIAL COLORS

Inodoro Suspendido  
Wall-hung WC

XX=

00

23 / 47 / 48

PÁG. 8

(56x39x33 cm)

36001xx2K

216 €

378 €

431 €

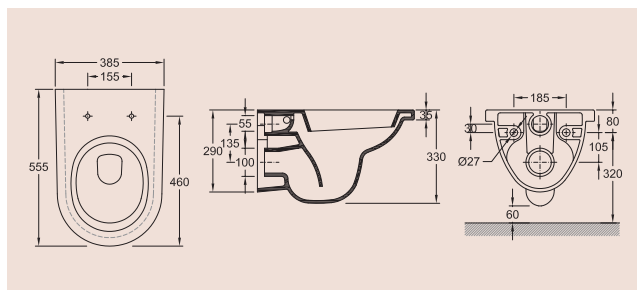

**TAMPO CM SC TAKE-OFF**

REF

BRANCO  
BLANCO  
WHITE

CORES STANDARD  
COLORES STANDARD  
STANDARD COLORS

CORES ESPECIAIS  
COLORES ESPECIALES  
SPECIAL COLORS

Tapa CM SC take-off  
Toilet seat CM SC take-off

XX=

00

23 / 47 / 48

PÁG. 8

50243xx0

125 €

218 €

250 €

**TAMPO CM**

Tapa CM  
Toilet seat CM

50242xx0

98 €

171 €

196 €

**BIDÉ SUSPENSO**

REF

BRANCO  
BLANCO  
WHITE

CORES STANDARD  
COLORES STANDARD  
STANDARD COLORS

CORES ESPECIAIS  
COLORES ESPECIALES  
SPECIAL COLORS

Bidé Suspendido  
Wall-hung bidet

XX=

00

23 / 47 / 48

PÁG. 8

(56x39x23 cm)

36401xx2K

152 €

266 €

304 €

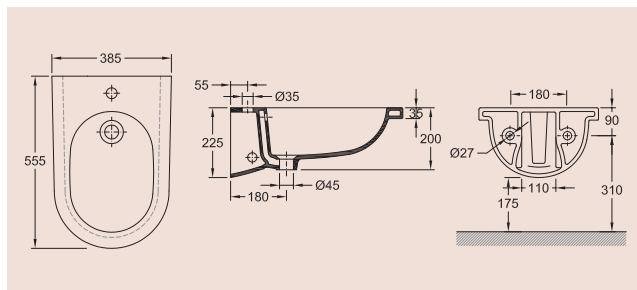

BRANCO  
BLANCO  
WHITE

CORES STANDARD  
COLORES STANDARD  
STANDARD COLORS

CORES ESPECIAIS  
COLORES ESPECIALES  
SPECIAL COLORS

REF

LAVATÓRIO NORMAL

XX= 00

23 / 47 / 48

PÁG. 8

Lavabo normal  
Washbasin normal

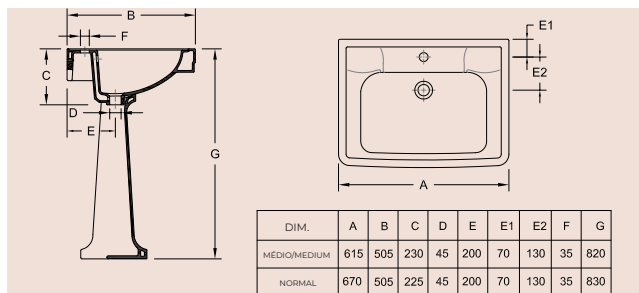

155 €

271 €

309 €

16321xx2C

(67x50x23 cm)

129 €

226 €

258 €

16331xx2C

LAVATÓRIO MÉDIO

Lavabo médio  
Washbasin medium  
(61x50x23 cm)

117 €

204 €

233 €

16200xx2K

COLUNA

Columna  
Pedestal

BRANCO  
BLANCO  
WHITE

CORES STANDARD  
COLORES STANDARD  
STANDARD COLORS

CORES ESPECIAIS  
COLORES ESPECIALES  
SPECIAL COLORS

REF

LAVATÓRIO RETANGULAR DE EMBUTIR

XX= 00

23 / 47 / 48

PÁG. 8

Lavabo sobre encimera retangular  
Embedded rectangular washbasin

312 €

547 €

624 €

16381XX2C

(60x46x4 cm)

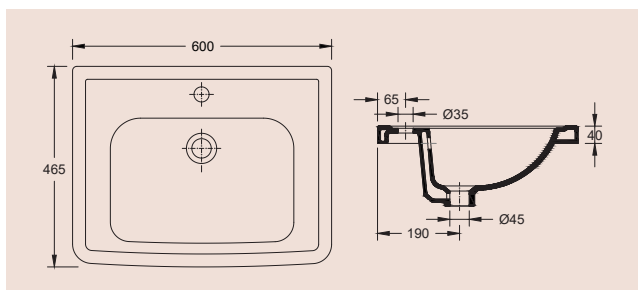

**ESTRUTURA C/ PRATELEIRA**

REF

INOX POLIDO  
ACERO INOXIDABLE PULIDO  
POLISHED STAINLESS STEEL

Estructura con estante  
Console and shelf

55182000

444 €

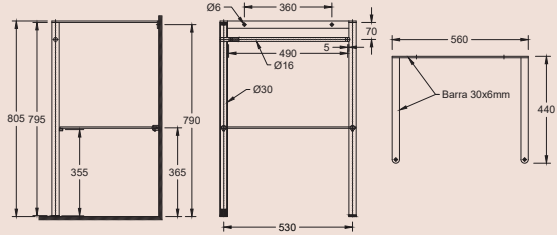

**BACIA COMPACTA V/H**

REF

BRANCO  
BLANCO  
WHITE

CORES STANDARD  
COLORES STANDARD  
STANDARD COLORS

CORES ESPECIAIS  
COLORES ESPECIALES  
SPECIAL COLORS

Inodoro p/ tanque bajo V/H  
Close coupled WC V/H

XX=

00

23 / 47 / 48

PÁG. 8

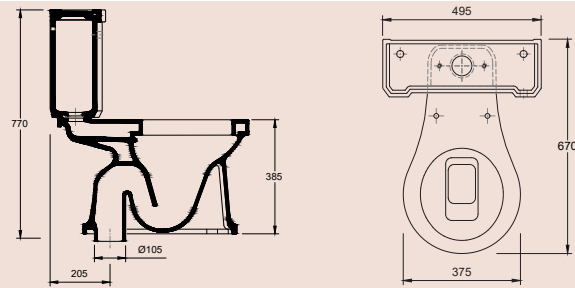

(67x38x40 cm)

16024xx2K

237 €

416 €

474 €

(67x38x40 cm)

16021xx2K

237 €

416 €

474 €

**TANQUE ALIMENTAÇÃO INFERIOR  
C/ MECANISMO**

Tanque alimentación inferior con  
mecanismo  
Bottom inlet cistern with mechanism

(50x18x37 cm)

16163xx2K

232 €

373 €

436 €

**TANQUE ALIMENTAÇÃO LATERAL  
C/ MECANISMO**

Tanque alimentación lateral con  
mecanismo  
Side inlet cistern with  
mechanism

(50x18x37 cm)

16161xx2K

232 €

373 €

436 €



BRANCO BLANCO WHITE	CORES STANDARD COLORES STANDARD STANDARD COLORS	CORES ESPECIAIS COLORES ESPECIALES SPECIAL COLORS	MADEIRA MADERA WOOD	REF	TAMPO CM SC TAKE-OFF
00	23 / 47 / 48	PÁG. 8			Tapa CM SC take-off Toilet seat CM SC take-off hinges
125 €	218 €	249 €	187 €	50376xx0	



BRANCO BLANCO WHITE	CORES STANDARD COLORES STANDARD STANDARD COLORS	CORES ESPECIAIS COLORES ESPECIALES SPECIAL COLORS	MADEIRA MADERA WOOD	REF	TAMPO CM
98 €	171 €	195 €	125 €	50343xx0	Tapa CM Toilet seat CM



Cores : "00" - branco/ "48" - preto/ "72" - castanho/ "22" - carvalho  
 Colores : "00" - blanco/ "48" - negro/ "72" - marron/ "22" - roble  
 Colors : "00" - white/ "48" - black/ "72" - brown/ "22" - oak

BRANCO BLANCO WHITE	CORES STANDARD COLORES STANDARD STANDARD COLORS	CORES ESPECIAIS COLORES ESPECIALES SPECIAL COLORS	REF	BIDÉ
XX= 00	23 / 47 / 48	PÁG. 8		Bidé Bidet
199 €	349 €	398 €	16411xx2K	(60x35x38 cm)

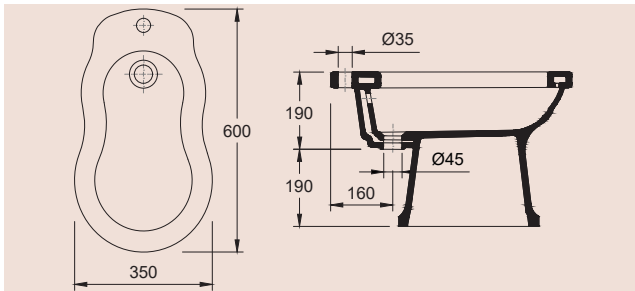

BRANCO BLANCO WHITE	CORES STANDARD COLORES STANDARD STANDARD COLORS	CORES ESPECIAIS COLORES ESPECIALES SPECIAL COLORS	REF	LAVATÓRIO MÉDIO C/ ESPALDAR
XX= 00	23 / 47 / 48	PÁG. 8		Lavabo médio con copete Washbasin medium w/ back splash

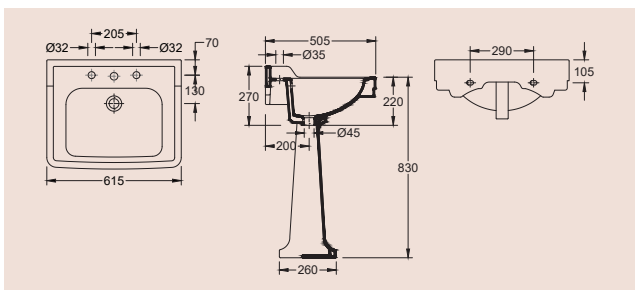

205 €	359 €	410 €	16351xx2C	(61x50x27 cm)
-------	-------	-------	-----------	---------------



BRANCO BLANCO WHITE	CORES STANDARD COLORES STANDARD STANDARD COLORS	CORES ESPECIAIS COLORES ESPECIALES SPECIAL COLORS	REF	COLUNA
117 €	204 €	233 €	16200xx2K	Columna Pedestal



**LAVA-MÃOS C/ ESPALDAR 1 F.**

**REF**

BRANCO  
BLANCO  
WHITE

CORES STANDARD  
COLORES STANDARD  
STANDARD COLORS

CORES ESPECIAIS  
COLORES ESPECIALES  
SPECIAL COLORS

XX= 00 23 / 47 / 48 PÁG. 8

Lava-manos c/ copete 1 Orifício  
Hand washbasin w/ back splash 1 hole  
(49x33x22 cm)

16361xx2C

117 €

204 €

233 €

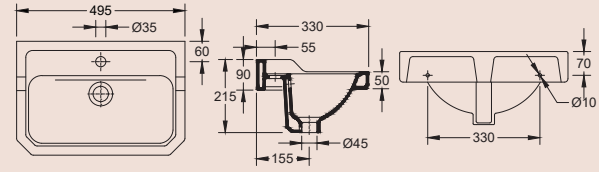

**BACIA NORMAL V**

**REF**

BRANCO  
BLANCO  
WHITE

CORES STANDARD  
COLORES STANDARD  
STANDARD COLORS

CORES ESPECIAIS  
COLORES ESPECIALES  
SPECIAL COLORS

XX= 00 23 / 47 / 48 PÁG. 8

Inodoro p/ tanque empotrado / alto V  
WC concealed V

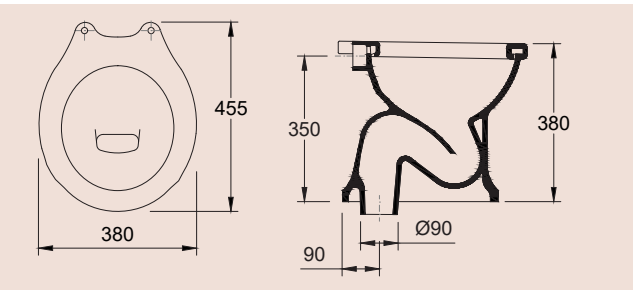

(46x38x38 cm)

16014xx2K

199 €

349 €

398 €

**BACIA NORMAL H**

Inodoro p/ tanque empotrado / alto H  
WC concealed H  
(46x38x38 cm)

16011xx2K

199 €

349 €

398 €

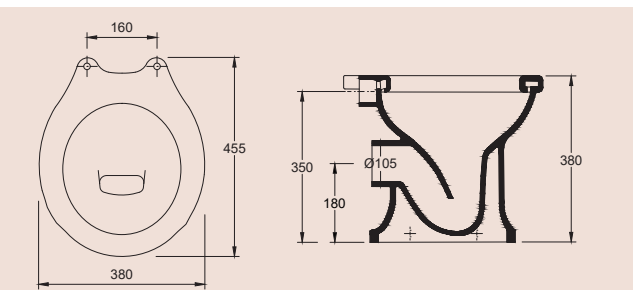

BRANCO BLANCO WHITE	CORES STANDARD COLORES STANDARD STANDARD COLORS	CORES ESPECIAIS COLORES ESPECIALES SPECIAL COLORS	REF	TANQUE ALIMENTAÇÃO INFERIOR C/ MECANISMO
XX= 00	23 / 47 / 48	PÁG. 8		Tanque alimentación inferior con mecanismo Bottom inlet cistern with mechanism
232 €	373 €	436 €	16163xx2K	(50x18x37 cm)

				TANQUE ALTO C/ MECANISMO
				Tanque alto con mecanismo High level cistern with mechanism
357 €	505 €	564 €	16131xx2K	(50x18x37 cm)

BRANCO BLANCO WHITE	CORES STANDARD COLORES STANDARD STANDARD COLORS	CORES ESPECIAIS COLORES ESPECIALES SPECIAL COLORS	MADEIRA MADERA WOOD	REF	TAMPO CM SC TAKE-OFF
00	23 / 47 / 48	PÁG. 8			Tapa CM SC take-off Toilet seat CM SC take-off hinges
125 €	218 €	249 €	187 €	50377xx0	

				TAMPO CM
				Tapa CM Toilet seat CM
98 €	171 €	195 €	125 €	50344xx0

Cores : "00" - branco/ "48" - preto/ "72" - castanho/ "22" - carvalho  
 Colores: "00" - blanco/ "48" - negro/ "72" - marron/ "22" - roble  
 Colors: "00" - white/ "48" - black/ "72" - brown/ "22" - oak



**BACIA NORMAL BTW H**

REF

BRANCO  
BLANCO  
WHITE

CORES STANDARD  
COLORES STANDARD  
STANDARD COLORS

CORES ESPECIAIS  
COLORES ESPECIALES  
SPECIAL COLORS

Inodoro p/ tanque  
empotrado BTW H  
WC concealed BTW H

XX= 00

23 / 47 / 48

PÁG. 8

(50x37x40 cm)

16041xx2K

312 €

547 €

624 €

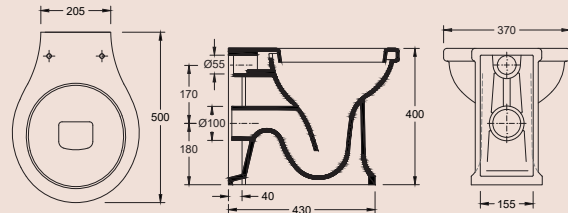

**TAMPO CM SC TAKE-OFF**

REF

BRANCO  
BLANCO  
WHITE

CORES STANDARD  
COLORES STANDARD  
STANDARD COLORS

CORES ESPECIAIS  
COLORES ESPECIALES  
SPECIAL COLORS

MADEIRA  
MADERA  
WOOD

Tapa CM SC take-off  
Toilet seat CM SC take-off  
hinges

50376xx0

125 €

218 €

249 €

187 €

**TAMPO CM**

Tapa CM  
Toilet seat CM

50343xx0

98 €

171 €

195 €

125 €

Cores : "00" - branco/ "48" - preto/ "72" - castanho/ "22" - carvalho  
Colores: "00" - blanco/ "48" - negro/ "72" - marron/ "22" - roble  
Colors: "00" - white/ "48" - black/ "72" - brown/ "22" - oak

**BIDÉ BTW**

REF

BRANCO  
BLANCO  
WHITE

CORES STANDARD  
COLORES STANDARD  
STANDARD COLORS

CORES ESPECIAIS  
COLORES ESPECIALES  
SPECIAL COLORS

Bidé BTW  
Bidet BTW

XX= 00

23 / 47 / 48

PÁG. 8

(50x37x40 cm)

16441xx2K

274 €

480 €

548 €

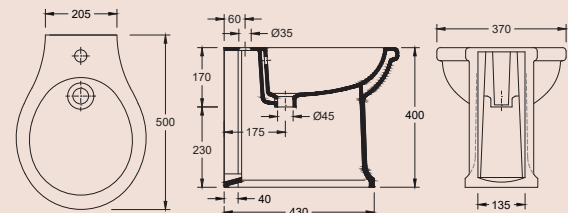

**LAVATÓRIO REDONDO DE EMBUTIR**

REF

BRANCO  
BLANCO  
WHITE

CORES STANDARD  
COLORES STANDARD  
STANDARD COLORS

CORES ESPECIAIS  
COLORES ESPECIALES  
SPECIAL COLORS

Lavabo sobre encimera  
redondo  
Embedded round  
washbasin  
(Ø 45 cm)

XX= 00

23 / 47 / 48

PÁG. 8

16387xx2C

312 €

547 €

624 €

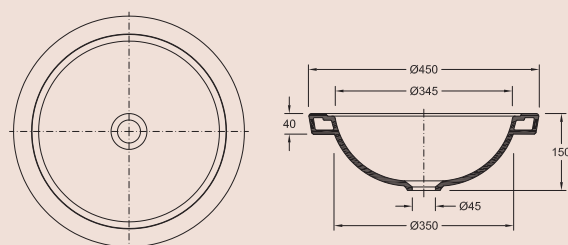

BRANCO BLANCO WHITE	CORES STANDARD COLORES STANDARD STANDARD COLORS	CORES ESPECIAIS COLORES ESPECIALES SPECIAL COLORS	REF	LAVATÓRIO SERRAS
XX= 00	23 / 47 / 48	PÁG. 8		Lavabo Serras Washbasin Serras
225 €	394 €	449 €	78840xx2C	(Ø 40 cm)

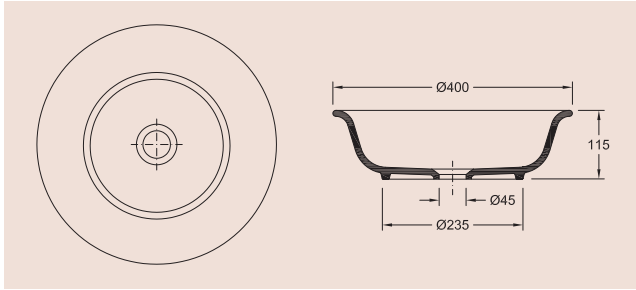

BRANCO BLANCO WHITE	CORES STANDARD COLORES STANDARD STANDARD COLORS	CORES ESPECIAIS COLORES ESPECIALES SPECIAL COLORS	REF	BACIA SUSPensa
XX= 00	23 / 47 / 48	PÁG. 8		Inodoro Suspendido Wall-hung WC
398 €	697 €	796 €	16001xx2K	(50x37x30 cm)

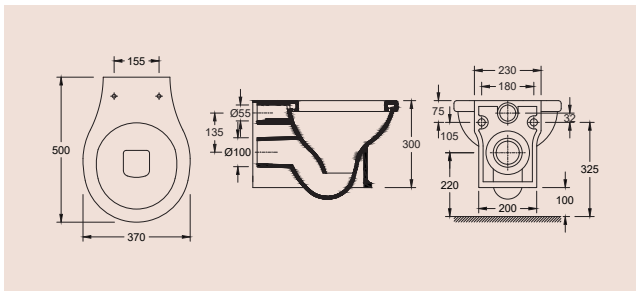

BRANCO BLANCO WHITE	CORES STANDARD COLORES STANDARD STANDARD COLORS	CORES ESPECIAIS COLORES ESPECIALES SPECIAL COLORS	MADEIRA MADERA WOOD	REF	TAMPO CM SC TAKE-OFF
125 €	218 €	249 €	187 €	50376xx0	Tapa CM SC take-off Toilet seat CM SC take-off hinges

BRANCO BLANCO WHITE	CORES STANDARD COLORES STANDARD STANDARD COLORS	CORES ESPECIAIS COLORES ESPECIALES SPECIAL COLORS	MADEIRA MADERA WOOD	REF	TAMPO CM
98 €	171 €	195 €	125 €	50343xx0	Tapa CM Toilet seat CM

Cores : "00" - branco/ "48" - preto/ "72" - castanho/ "22" - carvalho  
 Colores: "00" - blanco/ "48" - negro/ "72" - marron/ "22" - roble  
 Colors: "00" - white/ "48" - black/ "72" - brown/ "22" - oak



**BIDÉ SUSPENSO**

REF

BRANCO  
BLANCO  
WHITE

CORES STANDARD  
COLORES STANDARD  
STANDARD COLORS

CORES ESPECIAIS  
COLORES ESPECIALES  
SPECIAL COLORS

Bidé Suspendido  
Wall-hung bidet

(50x37x30 cm)

16401xx2K

XX=

00

23 / 47 / 48

PÁG. 8

312 €

547 €

624 €

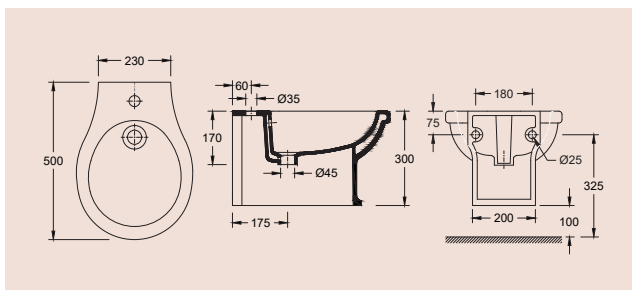



REF

**KIT FIXAÇÃO (LAVATÓRIOS)**

5 €

55007001

Kit de fijación nº1 (lavabos)  
Fixing kit nº1 (washbasins)

REF

**KIT FIXAÇÃO (BACIAS E BIDÉS)**

5 €

55007003

Kit de fijación nº3 (inodoros y bidés)  
Fixing kit nº3 (WC and bidets)

BRANCO  
BLANCO  
WHITE

CORES STANDARD  
COLORES STANDARD  
STANDARD COLORS

CORES ESPECIAIS  
COLORES ESPECIALES  
SPECIAL COLORS

REF

**PRATELEIRA CERÂMICA P/ ESTRUTURA DE LAVATÓRIO SERRAS**

XX=

00

23 / 47 / 48

PÁG. 8

Estante de cerâmica para estrutura de lavabo Serras  
Ceramic Shelf for Serras washbasin structure

58 €

102 €

115 €

21500xx2

REF

**TUBO DE DESCARGA HORIZONTAL 25CM (BACIA BTW)**

21 €

55040010

Tubo de descarga horizontal 25cm (inodoro BTW)  
Horizontal discharge tube 25cm( BTW WC)

BRANCO  
BLANCO  
WHITE

CORES STANDARD  
COLORES STANDARD  
STANDARD COLORS

CORES ESPECIAIS  
COLORES ESPECIALES  
SPECIAL COLORS

REF

**MANÍPULO FRONTAL CERÂMICO**

XX=

00

23 / 47 / 48

PÁG. 8

Palanca frontal en cerâmica  
Ceramic front handle

57 €

99 €

113 €

51004xx2

REF

**MECANISMO COMPACTO ENTRADA INFERIOR S/ MANÍPULO**

32 €

55503000

Mecanismo compacto de entrada inferior sin palanca  
Mechanism for close coupled WC, bottom inlet, without handle

REF

**MECANISMO COMPACTO ENTRADA LATERAL S/ MANÍPULO**

32 €

55504000

Mecanismo compacto de entrada lateral sin palanca  
Mechanism for close coupled WC, side inlet, without handle

REF

**MECANISMO NORMAL ENTRADA INFERIOR S/ MANÍPULO**

43 €

55500000

Mecanismo normal de entrada inferior sin palanca  
Mechanism for concealed WC, bottom inlet, without handle

BRANCO  
BLANCO  
WHITE

CORES STANDARD  
COLORES STANDARD  
STANDARD COLORS

CORES ESPECIAIS  
COLORES ESPECIALES  
SPECIAL COLORS

REF

**PUXADOR CERÂMICO P/ TANQUE ALTO**

XX=

00

23 / 47 / 48

PÁG. 8

Tirador de cerâmica para tanque alto  
Ceramic handle for high level cistern

29 €

52 €

58 €

51006xx2

REF

**MECANISMO P/ TANQUE ALTO S/ PUXADOR CERÂMICO**

156 €

50591000

Mecanismo para tanque alto sin tirador cerámico  
Mechanism for high level cistern without ceramic handle

**MECANISMO P/ TANQUE ALTO S/ TUBO**

REF

Mecanismo para tanque alto sin tubo  
Mechanism for high level cistern w/o tube

50591011

46 €

**TUBO CROMADO P/ MECANISMO DE TANQUE ALTO**

REF

Tubo cromo para mecanismo de tanque alto  
Chrome tube for high level cistern mechanism

55112001

118 €

**MECANISMO COMPACTO ALIMENTAÇÃO INFERIOR C/ MANÍPULO FRONTAL CERÂMICO**

REF

BRANCO  
BLANCO  
WHITE

CORES STANDARD  
COLORES STANDARD  
STANDARD COLORS

CORES ESPECIAIS  
COLORES ESPECIALES  
SPECIAL COLORS

Mecanismo compacto alimentación inferior c/ palanca en cerámica

XX=

00

23 / 47 / 48

PÁG. 8

Mechanism for close coupled WC, bottom inlet w/ ceramic frontal handle

55503xx1

84 €

112 €

138 €

**MECANISMO COMPACTO ALIMENTAÇÃO LATERAL C/ MANÍPULO FRONTAL CERÂMICO**

REF

BRANCO  
BLANCO  
WHITE

CORES STANDARD  
COLORES STANDARD  
STANDARD COLORS

CORES ESPECIAIS  
COLORES ESPECIALES  
SPECIAL COLORS

Mecanismo compacto alimentación lateral c/ palanca en cerámica

XX=

00

23 / 47 / 48

PÁG. 8

Mechanism for close coupled WC, side inlet w/ ceramic frontal handle

55503xx2

84 €

112 €

138 €

**MECANISMO NORMAL ALIMENTAÇÃO INFERIOR C/ MANÍPULO FRONTAL CERÂMICO**

REF

BRANCO  
BLANCO  
WHITE

CORES STANDARD  
COLORES STANDARD  
STANDARD COLORS

CORES ESPECIAIS  
COLORES ESPECIALES  
SPECIAL COLORS

Mecanismo normal alimentación inferior c/ palanca en cerámica

XX=

00

23 / 47 / 48

PÁG. 8

Mechanism for concealed WC w/ bottom inlet and frontal ceramic handle

55500xx1

129 €

156 €

183 €

**MECANISMO P/ TANQUE ALTO COM PUXADOR CERÂMICO**

REF

BRANCO  
BLANCO  
WHITE

CORES STANDARD  
COLORES STANDARD  
STANDARD COLORS

CORES ESPECIAIS  
COLORES ESPECIALES  
SPECIAL COLORS

Mecanismo tanque alto con tirador cerámico

XX=

00

23 / 47 / 48

PÁG. 8

Mechanism for high level cistern, with ceramic handle

50591xx1

191 €

205 €

220 €



BRANCO  
BLANCO  
WHITE

REF

**LAVATÓRIO DE POUSAR**

XX= 00

Lavabo sobre mueble  
Standing Washbasin

184 €

42350xx2C

(Ø 40 cm)

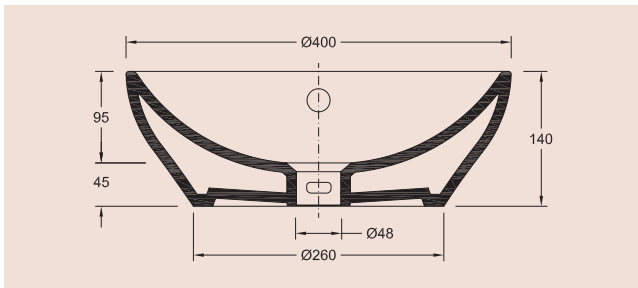

BRANCO  
BLANCO  
WHITE

REF

**BACIA COMPACTA RIMLESS V/H**

XX= 00

Inodoro p/ tanque bajo Rimless V/H  
Close coupled WC Rimless V/H

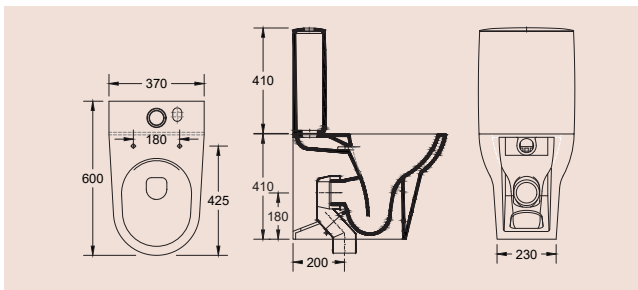

202 €

42551xx2V

(60x37x41 cm)

202 €

42551xx2H

(60x37x41 cm)



**TANQUE DE ALIMENTAÇÃO INFERIOR C/ MECANISMO**

Tanque alimentación inferior con mecanismo  
Bottom inlet cistern with mechanism

110 €

42182xx2K

(37x13x41 cm)





**TAMPO TERMODUR SC TAKE-OFF**

REF

BRANCO  
BLANCO  
WHITE

Tapa termodur SC Take-off  
Toilet seat SC take-off

XX= 00



(50x37x40 cm)

50210xx0

80 €



**TAMPO TERMODUR TAKE-OFF**

Tapa termodur Take-off  
Toilet seat take-off

50211xx0

56 €



**TAMPO TERMODUR SLIM SC TAKE-OFF**

REF

BRANCO  
BLANCO  
WHITE

Tapa termodur slim SC Take-off  
Toilet seat slim SC take-off

XX= 00



50204xx0

80 €



**TAMPO TERMODUR SLIM TAKE-OFF**

Tapa termodur slim Take-off  
Toilet seat slim take-off

50205xx0

56 €



**BIDÉ**

REF

BRANCO  
BLANCO  
WHITE

Bidé  
Bidet

XX= 00

(50x37x41 cm)

42411xx2K

138 €

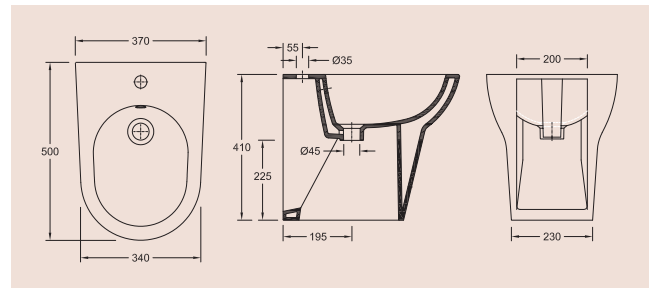

BRANCO  
BLANCO  
WHITE

REF

**LAVATÓRIO DE POUSAR**

XX= 00

Lavabo sobre mueble  
Standing Washbasin  
(Ø 40 cm)

184 €

42350xx2C

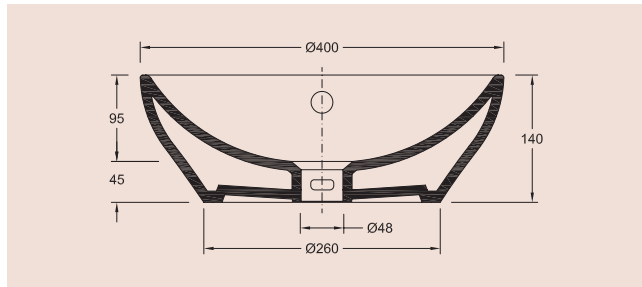

BRANCO  
BLANCO  
WHITE

REF

**BACIA SUSPensa RIMLESS**

XX= 00

Inodoro suspenso rimless  
Wall-hung WC rimless  
(50x37x33 cm)

144 €

42501xx2K

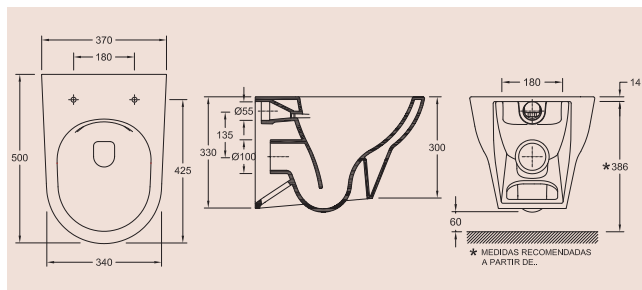

BRANCO  
BLANCO  
WHITE

REF

**TAMPO TERMODUR SC TAKE-OFF**

XX= 00

Tapa termodur SC Take-off  
Toilet seat SC take-off

80 €

50210xx0



56 €

50211xx0

**TAMPO TERMODUR TAKE-OFF**

Tapa termodur Take-off  
Toilet seat take-off



**TAMPO TERMODUR SLIM SC TAKE-OFF** REFBRANCO  
BLANCO  
WHITETapa termodur slim SC take-off  
Toilet seat slim SC take-off

XX= 00



50204xx0

80 €

**TAMPO TERMODUR SLIM TAKE-OFF**Tapa termodur slim take-off  
Toilet seat slim take-off

50205xx0

56 €

**BIDÉ SUSPENSO** REFBRANCO  
BLANCO  
WHITEBidé Suspendido  
Wall-hung bidet

XX= 00

(50x37x33 cm)

42401xx2K

121 €

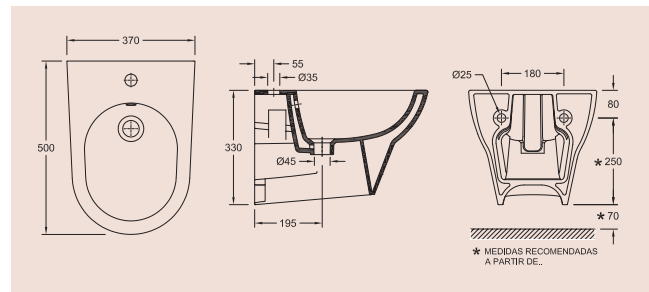
**MECANISMO DD** REF

REF

Mecanismo DD  
Mechanism DD

55519032

32 €

BRANCO  
BLANCO  
WHITE

REF

**LAVATÓRIO MÉDIO**

XX= 00

Lavabo médio  
Washbasin medium

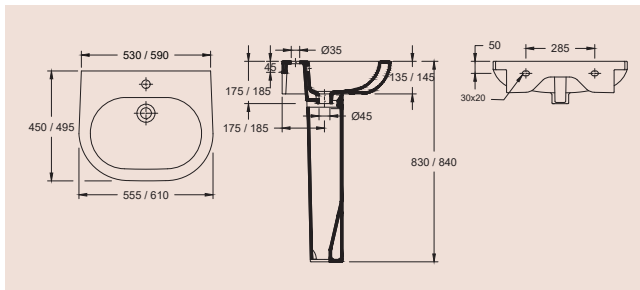

76 €

37331xx2C

(61x50x19 cm)



67 €

37311xx2C

**LAVATÓRIO JÚNIOR**

Lavabo Júnior  
Washbasin Junior  
(56x45x18 cm)



36 €

37200xx2K

**COLUNA**

Columna  
Pedestal



BRANCO  
BLANCO  
WHITE

REF

**BACIA COMPACTA V/H**

XX= 00

Inodoro p/ tanque baixo V/H  
Close coupled WC V/H

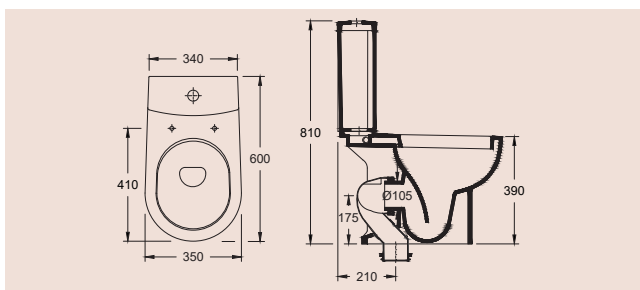

121 €

37051xx2V

(60x35x39 cm)

121 €

37051xx2H

(60x35x39 cm)



91 €

37182xx2K

**TANQUE ALIMENTAÇÃO INFERIOR  
C/ MECANISMO**

Tanque alimentación inferior con  
mecanismo  
Bottom inlet cistern with  
mechanism  
(32x15x40 cm)



91 €

37181xx2K

**TANQUE ALIMENTAÇÃO LATERAL  
C/ MECANISMO**

Tanque alimentación lateral con  
mecanismo  
Side inlet cistern with mechanism

(32x15x40 cm)



**BACIA NORMAL BTW V/H**

REF

BRANCO  
BLANCO  
WHITE

Inodoro p/ tanque empotrado BTW V/H  
WC concealed BTW V/H

XX= 00

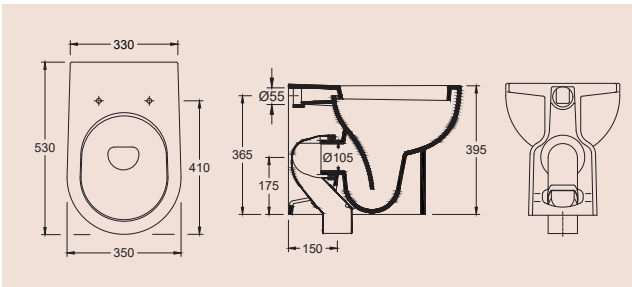

(53x35x40 cm)

37071xx2V

121 €

(53x35x40 cm)

37071xx2H

121 €

**TAMPO TERMODUR SC CLIP-OFF**

REF

BRANCO  
BLANCO  
WHITE

Tapa termodur SC clip-off  
Toilet seat SC clip-off

XX= 00

50206xx0

78 €

**TAMPO TERMODUR CLIP-OFF**

Tapa termodur clip-off  
Toilet seat clip-off

50207xx0

56 €

**BIDÉ**

REF

BRANCO  
BLANCO  
WHITE

Bidé  
Bidet

XX= 00

(55x36x40 cm)

37411xx2K

76 €

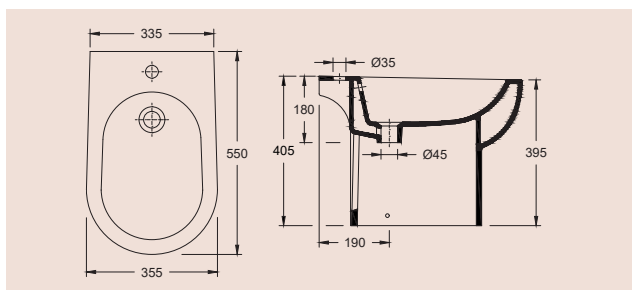

**BIDÉ BTW**

REF

BRANCO  
BLANCO  
WHITE

Bidé BTW  
Bidet BTW

XX= 00

(55x36x41 cm)

37441xx2K

111 €

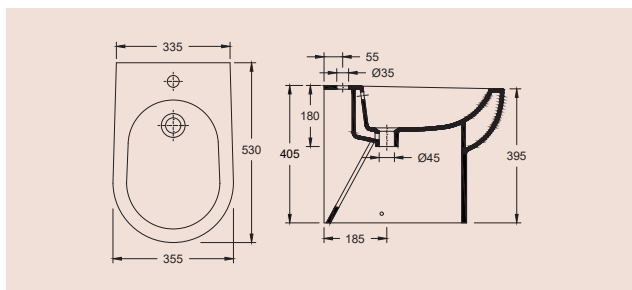

BRANCO  
BLANCO  
WHITE

XX= 00

REF

**LAVATÓRIO MÉDIO**

Lavabo médio  
Washbasin medium

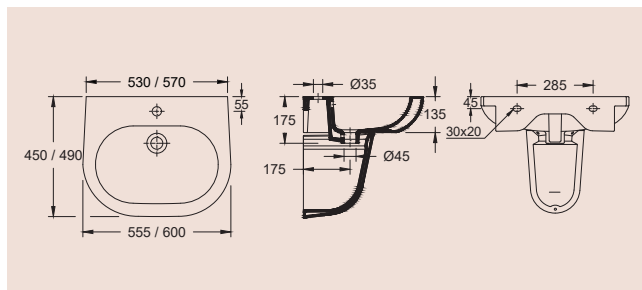

76 €

37331xx2C

(61x50x19 cm)



67 €

37311xx2C

**LAVATÓRIO JÚNIOR**

Lavabo Júnior  
Washbasin Junior



**COLUNA SUSPensa**

Columna Suspendida  
Wall-hung pedestal



55 €

37220xx2K

BRANCO  
BLANCO  
WHITE

XX= 00

REF

**BACIA SUSPensa**

Inodoro Suspendido  
Wall-hung WC



120 €

37001xx2K

(50x35x36 cm)

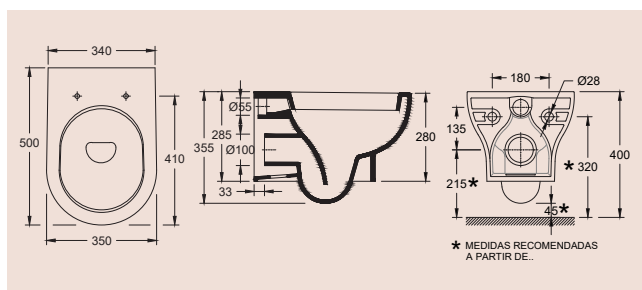

BRANCO  
BLANCO  
WHITE

XX= 00

REF

**TAMPO TERMODUR SC CLIP-OFF**

Tapa termodur SC clip-off  
Toilet seat SC clip-off hinges



78 €

50208xx0

**TAMPO TERMODUR CLIP-OFF**

Tapa termodur clip-off  
Toilet seat clip-off



56 €

50209xx0



**BIDÉ SUSPENSO**

REF

BRANCO  
BLANCO  
WHITE

Bidé Suspendido  
Wall-hung bidet

XX= 00

(51x36x28 cm)

37401xx2K

76 €

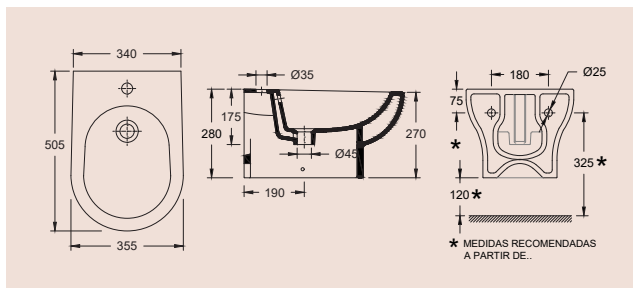

**PACK OPUS DESCARGA VERTICAL,  
MECANISMO ALIMENTAÇÃO  
INFERIOR, TAMPO SC**

REF

BRANCO  
BLANCO  
WHITE

Pack Opus descarga vertical, mecanismo  
alimentación inferior, tapa SC  
Pack Opus vertical discharge, Bottom  
inlet mechanism, SC toilet seat

XX= 00

37904xx2K

283 €



Também disponíveis com descarga horizontal e alimentação lateral  
Tambien disponibles con descarga horizontal y alimentación lateral  
Also available with horizontal discharge and side inlet mechanism

**PACK OPUS DESCARGA VERTICAL,  
MECANISMO ALIMENTAÇÃO  
INFERIOR, TAMPO**

REF

BRANCO  
BLANCO  
WHITE

Pack Opus descarga vertical, mecanismo  
alimentación inferior, tapa  
Pack Opus vertical discharge, Bottom  
inlet mechanism, toilet seat

XX= 00











37900xx2K

263 €



Também disponíveis com descarga horizontal e alimentação lateral  
Tambien disponibles con descarga horizontal y alimentación lateral  
Also available with horizontal discharge and side inlet mechanism



	<b>REF</b>	<b>KIT FIXAÇÃO P/ LAVATÓRIO</b>	
5 €	55007001	Kit de fijación p/ lavabo Fixing kit for washbasin	
	<b>REF</b>	<b>KIT FIXAÇÃO LATERAL</b>	
7 €	55185000	Kit de fijación lateral Side fixing kit	
	<b>REF</b>	<b>KIT FIXAÇÃO P/ COLUNA SUSPENSA</b>	
22 €	55126010	Kit de fijación p/ columna suspendida Fixing kit for wall-hung pedestal	
	<b>REF</b>	<b>CURVA DE DESCARGA VERTICAL (BTW)</b>	
21 €	55114011	Curva de descarga vertical (BTW) Vertical discharge curve (BTW)	
	<b>REF</b>	<b>TUBO DE DESCARGA HORIZONTAL 25CM</b>	
21 €	55040010	Tubo de descarga horizontal 25cm Horizontal discharge tube 25cm	
	<b>REF</b>	<b>MECANISMO DD ALIMENTAÇÃO INFERIOR</b>	
29 €	55519010	Mecanismo DD alimentación inferior Bottom inlet DD mechanism	
	<b>REF</b>	<b>MECANISMO DD DE ALIMENTAÇÃO LATERAL</b>	
29 €	55517101	Mecanismo DD alimentación lateral Side inlet DD mechanism	
	<b>REF</b>	<b>CURVA DE DESCARGA VERTICAL</b>	
21 €	55114030	Curva de descarga vertical Vertical discharge curve	
			
			

**LAVATÓRIO NORMAL**

REF

BRANCO  
BLANCO  
WHITE

Lavabo normal  
Washbasin normal

XX= 00

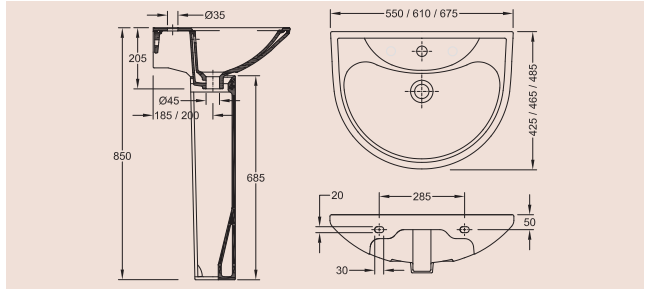

(68x49x21 cm)

13321xx2C

64 €

**LAVATÓRIO MÉDIO**

Lavabo médio  
Washbasin medium  
(61x47x21 cm)

13331xx2C

56 €

**LAVATÓRIO JÚNIOR**

Lavabo júnior  
Washbasin junior  
(55x43x21 cm)

13311xx2C

46 €

**COLUNA**

Columna  
Pedestal

37200xx2K

36 €

REF

BRANCO  
BLANCO  
WHITE

**BACIA COMPACTA V**

Inodoro p/ tanque baixo V  
Close coupled WC V

XX= 00

(69x37x40 cm)

13023xx2K

69 €

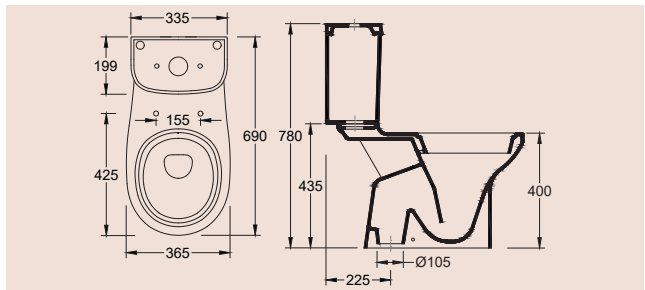

**BACIA COMPACTA H**

Inodoro p/ tanque baixo H  
Close coupled WC H

(69x37x40 cm)

13021xx2K

69 €

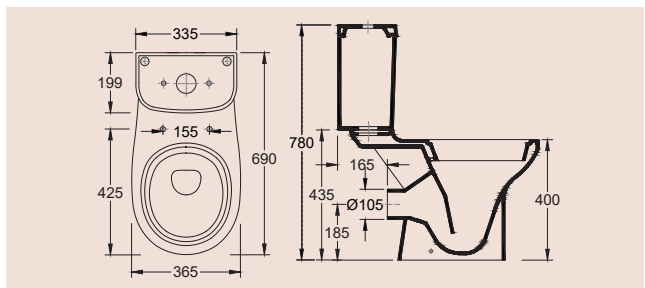

BRANCO  
BLANCO  
WHITE

REF

**TANQUE ALIMENTAÇÃO INFERIOR  
C/ MECANISMO**

XX= 00

Tanque alimentación inferior con mecanismo  
Bottom inlet ceramic cistern with mechanism

72 €

13182xx2K

(34x20x34 cm)



**TANQUE ALIMENTAÇÃO LATERAL  
C/ MECANISMO**

Tanque alimentación lateral con mecanismo  
Side inlet cistern with mechanism

72 €

13181xx2K

(34x20x34 cm)



BRANCO  
BLANCO  
WHITE

REF

**BACIA NORMAL V**

XX= 00

Inodoro p/ tanque empotrado V  
WC concealed V  
(57x37x42 cm)

69 €

13013xx2K

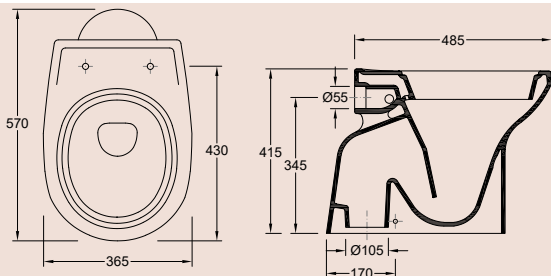

BRANCO  
BLANCO  
WHITE

REF

**TAMPO TERMODUR**

XX= 00

Tapa termodur  
Toilet seat

44 €

50340xx0



BRANCO  
BLANCO  
WHITE

REF

**BIDÉ**

XX= 00

Bidé  
Bidet

71 €

13411xx2K

(56x37x40 cm)

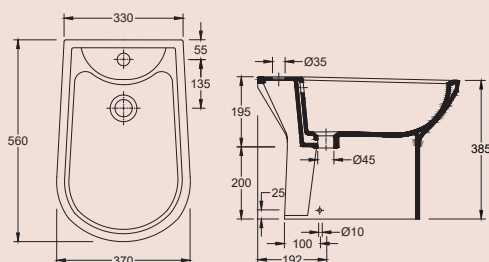

**LAVATÓRIO NORMAL**

REF

BRANCO  
BLANCO  
WHITE

Lavabo normal  
Washbasin normal

XX= 00

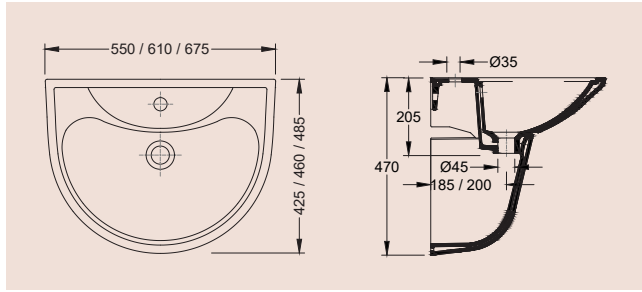

(68x49x21 cm)

13321xx2C

64 €

**LAVATÓRIO MÉDIO**

Lavabo médio  
Washbasin medium  
(61x47x21 cm)

13331xx2C

56 €

**LAVATÓRIO JÚNIOR**

Lavabo júnior  
Washbasin junior  
(55x43x21 cm)

13311xx2C

46 €

**COLUNA SUSPensa**

Columna Suspendida  
Wall-hung pedestal  
(55x43x21 cm)

37220xx2K

55 €

**BACIA SUSPensa**

REF

BRANCO  
BLANCO  
WHITE

Inodoro Suspendido  
Wall-hung WC

XX= 00

(53x37x38 cm)

13001xx2K

75 €

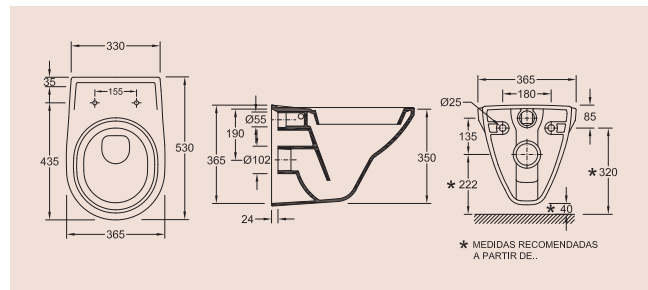

\* MEDIDAS RECOMENDADAS A PARTIR DE...

**TAMPO TERMODUR**

REF

BRANCO  
BLANCO  
WHITE

Tapa termodur  
Toilet seat  
(55x43x21 cm)

XX= 00

50340xx0

44 €

BRANCO  
BLANCO  
WHITE

REF

**BIDÉ SUSPENSO**

XX= 00

Bidé Suspendido  
Wall-hung bidet

66 €

13401xx2K

(54x37x37 cm)

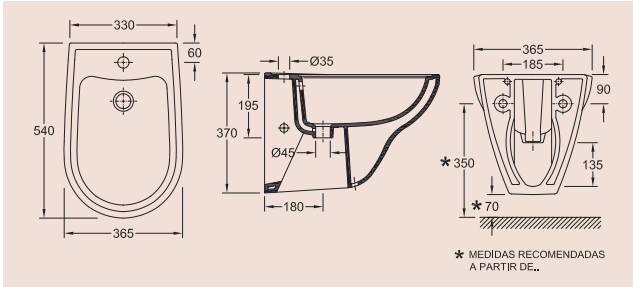

BRANCO  
BLANCO  
WHITE

REF

**PACK OCEANUS DESCARGA VERTICAL,  
MECANISMO ALIMENTAÇÃO INFERIOR,  
TAMPO**

XX= 00

Pack Oceanus descarga vertical,  
mecanismo alimentación inferior, tapa  
Pack Oceanus vertical discharge, Bottom  
inlet mechanism, toilet seat

181 €

13900xx2K

(54x37x37 cm)



Também disponível com descarga horizontal e alimentação lateral  
Tambien disponible con descarga horizontal e alimentación lateral  
Also available with horizontal discharge and side inlet mechanism



**KIT FIXAÇÃO P/ LAVATÓRIO**

REF

Kit de fijación p/ lavabo  
Fixing kit for washbasin

55007001

5 €

**KIT FIXAÇÃO LATERAL**

REF

Kit de fijación lateral  
Side fixing kit

55185001

7 €

**KIT FIXAÇÃO P/ COLUNA SUSPENSA**

REF

Kit de fijación p/ columna suspendida  
Fixing kit for wall-hung pedestal

55126010

22 €

**MECANISMO DD ALIMENTAÇÃO INFERIOR**

REF

Mecanismo DD alimentación inferior  
Bottom inlet DD mechanism

55517021

29 €

**MECANISMO DD ALIMENTAÇÃO LATERAL**

REF

Mecanismo DD alimentación lateral  
Side inlet DD mechanism

55517041

29 €



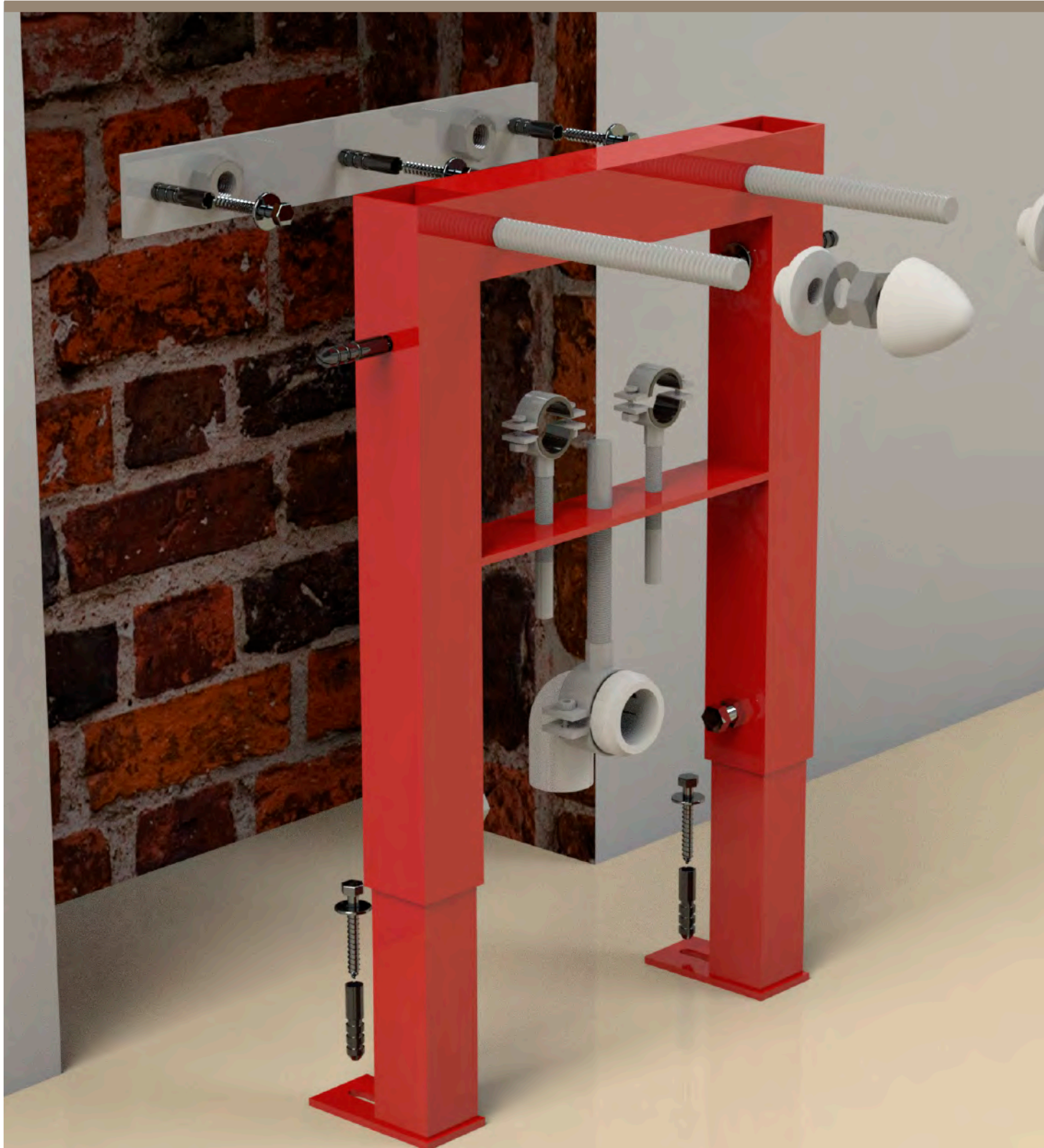





# ESTRUTURAS

## ESTRUCTURAS

## STRUCTURES



### ESTRUTURAS P/ SANITÁRIO SUSPENSO

68

ESTRUCTURAS P/ SANITARIOS SUSPENDIDOS  
CONCEALED SYSTEMS FOR WALL-HUNG WC

### PLACAS DE COMANDO

70

PANELES DE CONTROL  
COMMAND PANELS

### ESTRUTURAS P/ INSTALAÇÃO DE URINÓIS

72

ESTRUCTURA PARA LA INSTALACIÓN DE URINARIOS  
URINALS INSTALLATION FRAME



**ESTRUTURA INTEGRAL  
(PLADUR E ALVENARIA;  
ESPESSURA 147MM**

REF

Estructura integral (manposteria y pladur; espesor 147mm)  
Concealed full frame (masonry and plasterboard; depth 147mm)

55037074

199 €

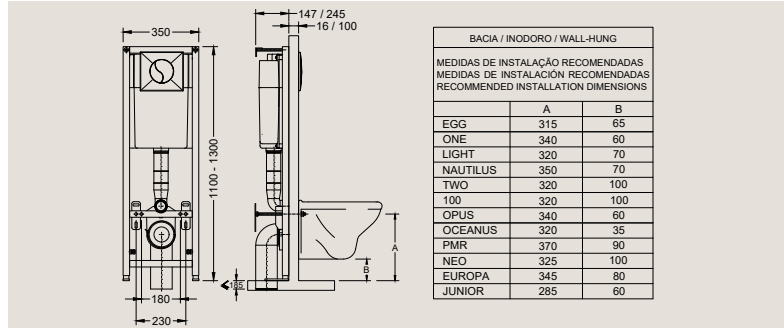

**ESTRUTURA AUTOPORTANTE  
(PAREDES DE PLADUR;  
ESPESSURA 147MM)**

REF

Estructura autoportante (paredes de pladur; espesor 147mm)  
Self-supporting frame (plasterboard walls; depth 147mm)

55037076

255 €

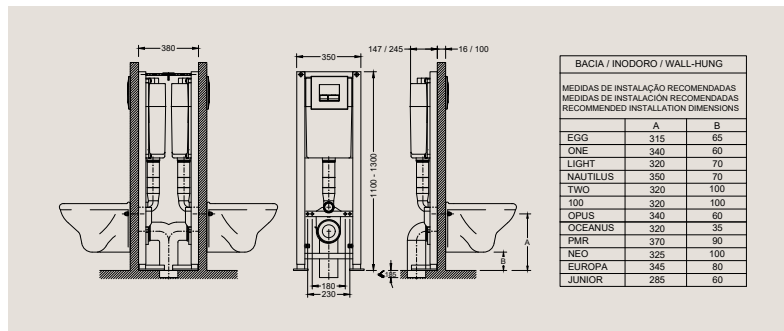

**KIT DE CONVERSÃO DE 2  
ESTRUTURAS 55037076 EM  
ESTRUTURA DUPLA**

REF

Kit de conversión de 2 estructuras 55037076 en estructura doble  
Conversion kit of 2 structures 55037076 in double structure

55037070

14 €

**"T" DE EVACUAÇÃO PARA  
ESTRUTURA DUPLA DE SANITA**

REF

"T" de evacuación para estructura doble de inodoro  
Evacuation "T" for double toilet structure

55037071

15 €

**ESTRUTURA INTEGRAL SLIM  
(PLADUR E ALVENARIA;  
ESPESSURA 93MM)**

REF

Estructura integral Slim (manposteria y pladur; espesor 93mm)  
Concealed full frame Slim (masonry and plasterboard; depth 93mm)

55037075

204 €

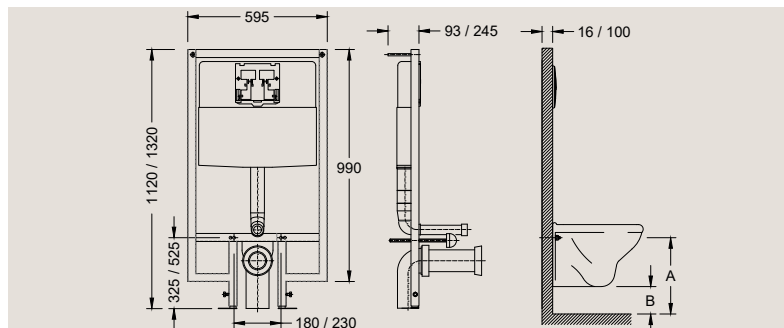

REF

**ESTRUTURA INTRASLIM (PAREDES DE ALVENARIA; ESPESSURA 93MM)**

145 €

55037094

Estructura Intraslim (paredes manposteria); espesor 93mm  
Concealed half frame Intraslim (masonry walls); depth 93mm

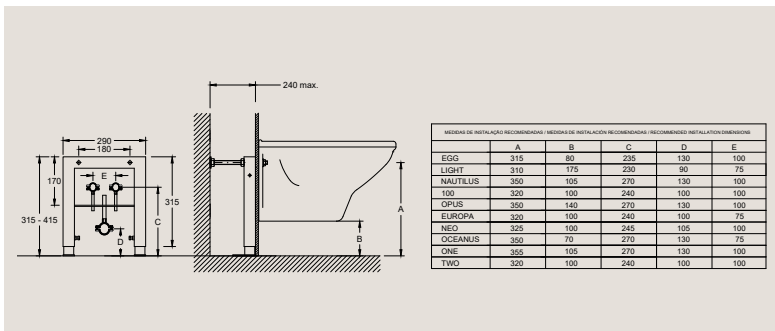

**BARRAS DE REFORÇO P/ 55037094 (OPCIONAL)**

55 €

55086021

Barras de refuerzo para 55037094 (opcional)  
Reinforcement bars for 55037094 (optional)



REF

**ESTRUTURA P/ BACIA SEM TANQUE**

127 €

55036201

Estructura para inodoro suspenso sin tanque  
Wall-mounted frame WC without flushing cistern

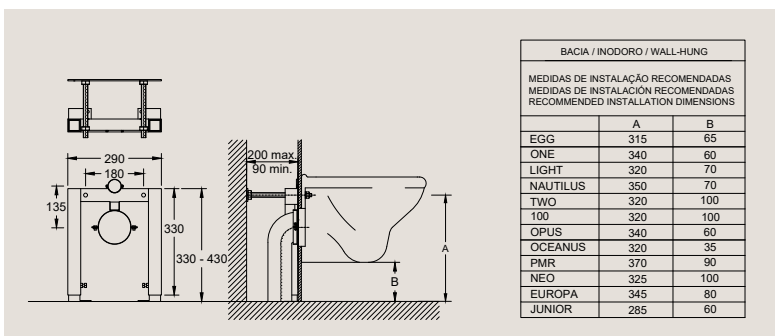

**TILE C/ FRONTAL CERÂMICO E FRAME CROMADA**

REF

BRANCO  
BLANCO  
WHITE

CORES STANDARD  
COLORES STANDARD  
STANDARD COLORS

CORES ESPECIAIS  
COLORES ESPECIALES  
SPECIALS COLORS

Tile con frontal cerâmico e cuadro cromo  
Tile with ceramic front panel and frame chrome

00

23 / 47 / 48

55038xx2

113 €

168 €

197 €

**TILE C/ FRONTAL CERÂMICO E FRAME BRANCA**

Tile con frontal cerâmico e cuadro blanco  
Tile with ceramic front panel and frame white

55038xx1

113 €

168 €

197 €

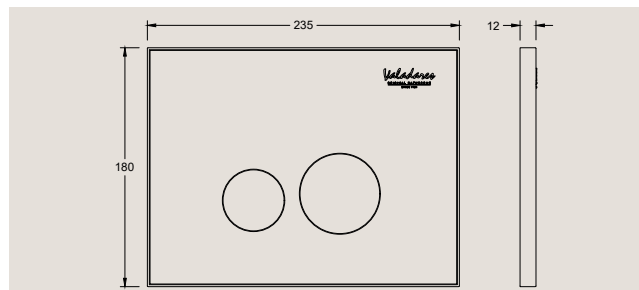

**SQUARE CROMADO**

REF

Square cromo  
Square chrome plated

55034301

53 €

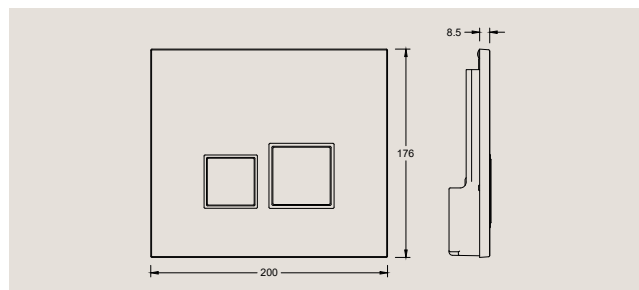

**SQUARE BRANCO**

Square blanco  
Square white

55034303

53 €

**SQUARE CROMADO MATE**

Square cromo mate  
Square matt chrome

55034304

53 €

**SQUARE PRETO**

Square negro  
Square black

55034305

53 €

**REF** **PLAT2 CROMADO**

37 €

55034201

PLAT2 cromo  
PLAT2 chrome plated

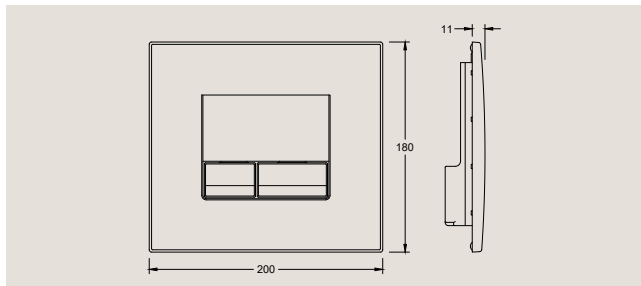

37 €

55034203

**PLAT2 BRANCO**  
PLAT2 blanco  
PLAT2 white



37 €

55034204

**PLAT2 CROMO MATE**  
PLAT2 cromo mate  
PLAT2 matt chrome



75 €

55034211

**PLAT2 ANTIVANDALISMO CROMADO**  
PLAT2 antivandálico cromado  
PLAT2 anti-vandalism chrome





EGG/ KINO

REF

55036010

349 €

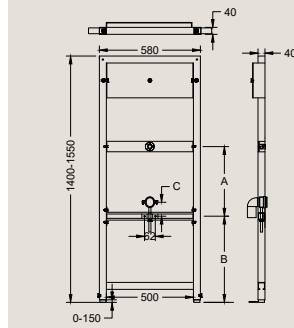

	EGG	Kino
A	320	400
B*	415	495
C*	145	80

\*MEDIDAS DE INSTALAÇÃO RECOMENDADAS  
 \*MEDIDAS DE INSTALACIÓN RECOMENDADAS  
 \*RECOMMENDED INSTALLATION DIMENSIONS



ORBITAL/ FLORIDA

REF

55036011

349 €

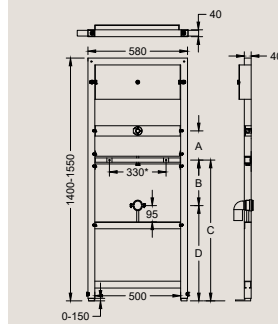

	Orbital	Florida
A	170	70
B*	265	460
C*	820	990
D	555	530

\*MEDIDAS DE INSTALAÇÃO RECOMENDADAS  
 \*MEDIDAS DE INSTALACIÓN RECOMENDADAS  
 \*RECOMMENDED INSTALLATION DIMENSIONS



FACE

REF

55036012

349 €

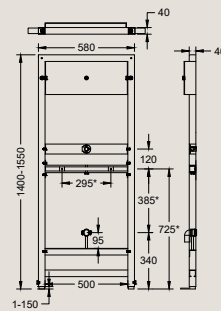

\*MEDIDAS DE INSTALAÇÃO RECOMENDADAS  
 \*MEDIDAS DE INSTALACIÓN RECOMENDADAS  
 \*RECOMMENDED INSTALLATION DIMENSIONS



REF

**ESTRUTURA P/ BIDÉS SUSPENSOS HIDE**

Estructura para bidés suspensos hide  
Frame for wall-hung hide bidets

94 €

55046001

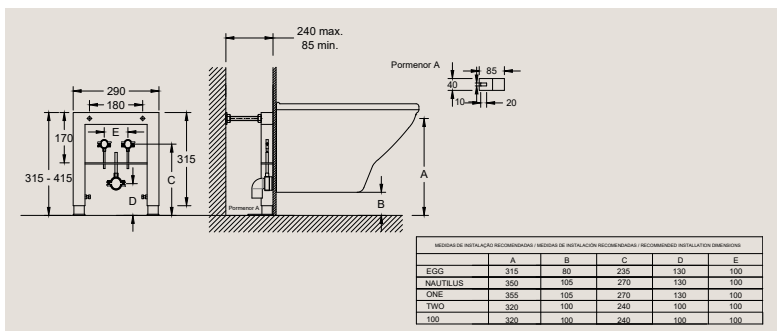

REF

**ESTRUTURA P/ BIDÉS SUSPENSOS C/ FIXAÇÃO VISÍVEL**

Estructura para bidés suspensos con fijación visible  
Frame for wall-hung bidets with visible fixation

101 €

55046001K

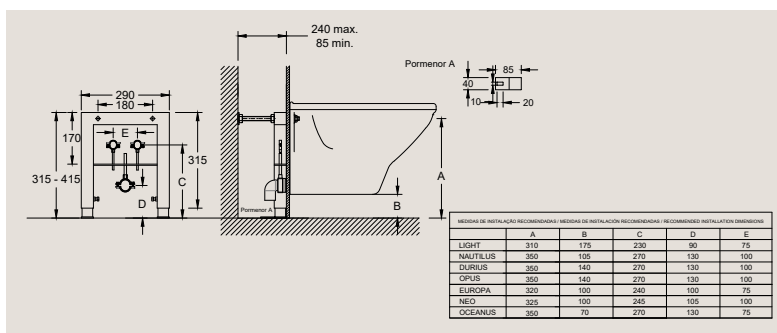

REF

**ESTRUTURA P/ LAVATÓRIO SUSPENSO**

Estructura para lavabo suspenso  
Washbasin wall-mount frame

132 €

55035001

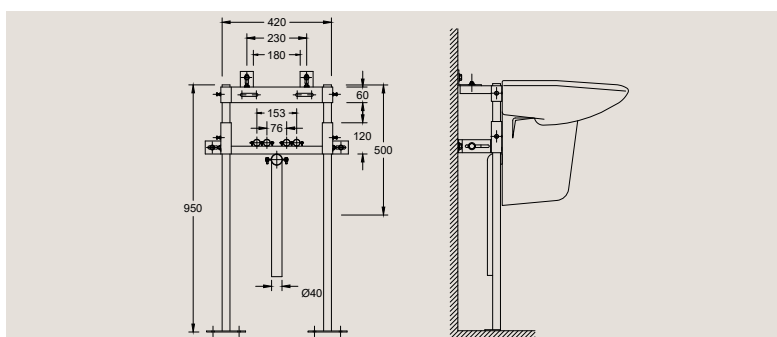







# LAVATÓRIOS

## LAVABOS

## WASHBASINS

**ESPECIAIS** 80  
ESPECIALES  
SPECIALS



**SUSPENSOS** 89  
SUSPENDIDOS  
WALL-HUNG



**LAVA-MÃOS** 92  
LAVA MANOS  
HAND WASHBASINS

**POUSAR** 94  
SOBRE MUEBLE  
STANDING



**EMBUTIR** 101  
SOBRE ENCIMERA  
EMBEDDED

**SEMI-EMBUTIR** 103  
SEMI-INTEGRAR  
SEMI-EMBEDDED



**ENCASTRAR** 104  
BAJO ENCIMERA  
RECESSED



ESPECIAIS | ESPECIALES | SPECIALS

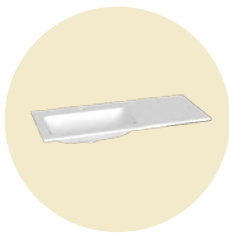

**PLATINIUM**  
PAG 80



**APOLO**  
PAG 84



**EGG**  
PAG 87



**KOBE**  
PAG 88

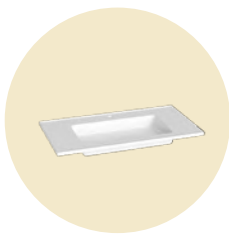

**PORTO**  
PAG 82

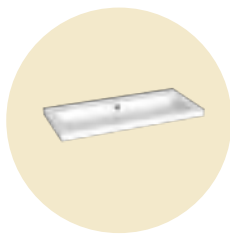

**RAFAEL**  
PAG 82

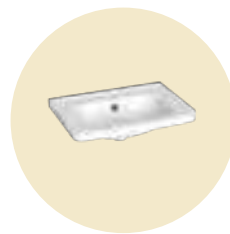

**NEO**  
PAG 87



**RUBENS**  
PAG 88



**SERRAS**  
PAG 85



**NEO**  
PAG 85

SUSPENSOS | SUSPENDIDOS | WALL-HUNG

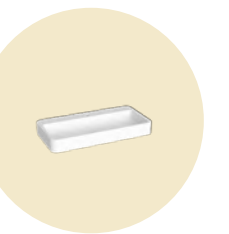

**AVIZ**  
PAG 89

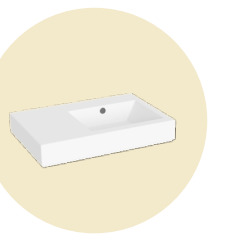

**GALLERY**  
PAG 91

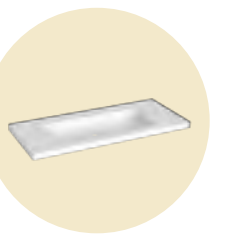

**ONE LINE**  
PAG 90

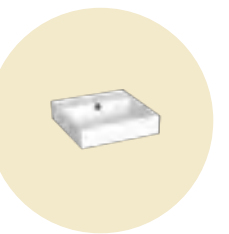

**RECIFE PLUS**  
PAG 91

LAVA-MÃOS | LAVA MANOS | HAND WASHBASINS



**CEUTA**  
PAG 93

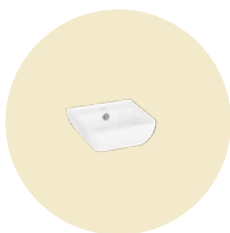

**EROS**  
PAG 92

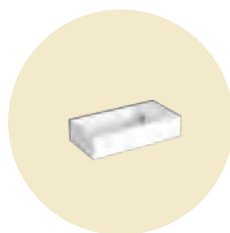

**ISIS**  
PAG 92



**LAVA-MÃOS**  
LAVA MANOS  
HAND WASHBASIN  
PAG 93



**VÊNUS**  
PAG 92



**LAVA-MÃOS DE CANTO**  
LAVA MANOS DE RINCON  
CORNER HAND WASHBASIN  
PAG 93

POUSAR | SOBRE MUEBLE | STANDING



**ATLANTA**  
PAG 101

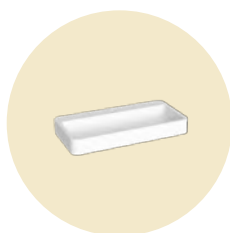

**AVIZ**  
PAG 94

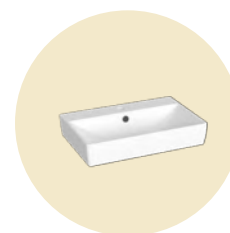

**BARI**  
PAG 94



**BOSTON**  
PAG 99

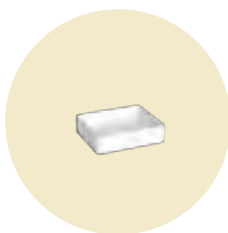

**CHAGALL**  
PAG 95



**DARK**  
PAG 100

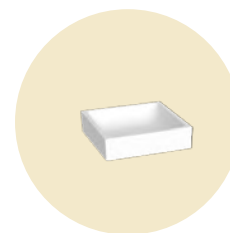

**DAYTONA**  
PAG 96

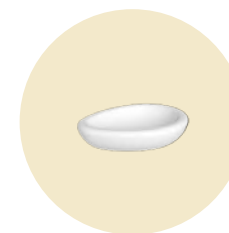

**EGG**  
PAG 97

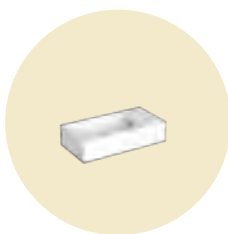

**ISIS**  
PAG 95

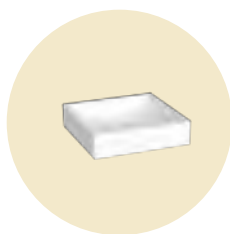

**MACAU**  
PAG 96



**MALIBU**  
PAG 98



**MALMO**  
PAG 95



POUSAR | SOBRE MUEBLE | STANDING

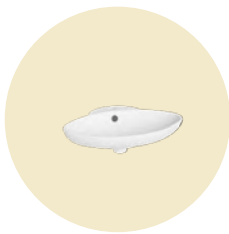

**MIAMI**  
PAG 101



**ONE BOLD**  
PAG 98



**ONE SLIM**  
PAG 98

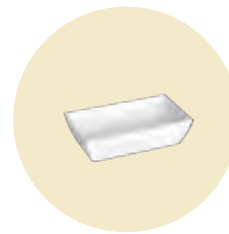

**PICASSO**  
PAG 96

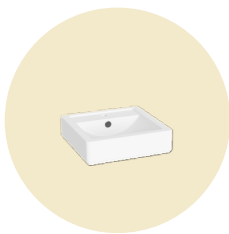

**RECIFE PLUS**  
PAG 97

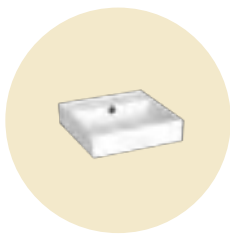

**RIO**  
PAG 97



**SAVOY**  
PAG 97



**TAITI**  
PAG 99



**TICIANO**  
PAG 100



**URANO**  
PAG 100

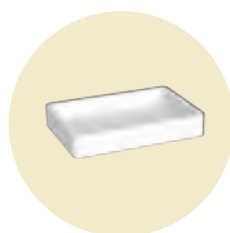

**VAN GOGH**  
PAG 94



**ZEN**  
PAG 99

EMBUTIR | SOBRE ENCIMERA | EMBEDDED



**GOA**  
PAG 101



**MIRAMAR**  
PAG 102



**MÓNACO**  
PAG 102

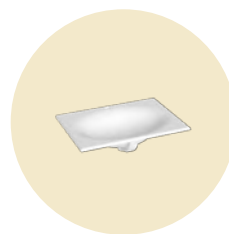

**OÁSIS**  
PAG 102



**PALM**  
PAG 102

SEMI-EMBUTIR | SEMI-INTEGRAR | SEMI- EMBEDDED

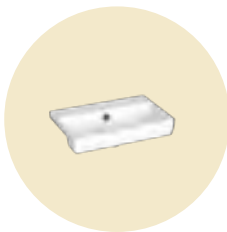

**BARI**  
PAG 103



**ROMA**  
PAG 103



**TORINO**  
PAG 103

ENCASTRAR | BAJO ENCIMERA | RECESSED



**DALI**  
PAG 106



**DANÚBIO**  
PAG 104

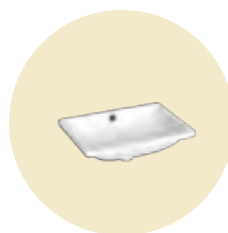

**MISSOURI**  
PAG 105

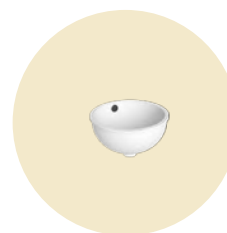

**NICE**  
PAG 104

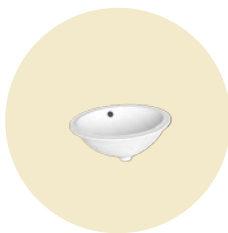

**OVAL**  
PAG 104



**TÂNGER**  
PAG 105

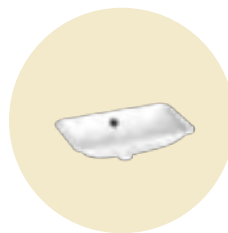

**TÂNGER S**  
PAG 106

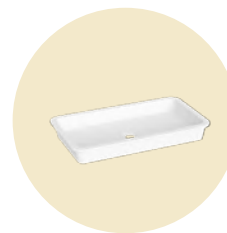

**TOLEDO**  
PAG 105



PLATINIUM

REF

BRANCO  
BLANCO  
WHITE

CORES STANDARD  
COLORES STANDARD  
STANDARD COLORS

CORES ESPECIAIS  
COLORES ESPECIALES  
SPECIAL COLORS

XX=

00

23 / 47 / 48

PÁG. 8

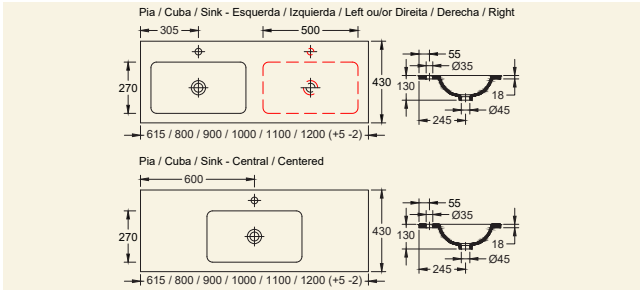

120 (120x43x13 cm)	79362xx2C	366 €	641 €	732 €
110 (110x43x13 cm)	79352xx2C	341 €	596 €	681 €
100 (100x43x13 cm)	79342xx2C	303 €	531 €	606 €
90 (90x43x13 cm)	79332xx2C	228 €	400 €	456 €
80 (80x43x13 cm)	79322xx2C	216 €	378 €	431 €

DIM.	120			110			100			90			80		
	E/I/L	D/R	C	E/I/L	D/R	C	E/I/L	D/R	C	E/I/L	D/R	C	E/I/L	D/R	C
79362XX2	X														
79363XX2		X													
79361XX2			X												
79352XX2				X											
79353XX2					X										
79351XX2						X									
79342XX2							X								
79343XX2								X							
79341XX2									X						
79332XX2										X					
79333XX2											X				
79331XX2												X			
79322XX2													X		
79323XX2														X	
79321XX2															X

E/I/L = Esquerdo / Izquierdo / Left  
D/R = Direito / Derecho / Right  
C = Central / Central / Centered

PLATINIUM 60 C/ PIO AO CENTRO

REF

BRANCO  
BLANCO  
WHITE

CORES STANDARD  
COLORES STANDARD  
STANDARD COLORS

CORES ESPECIAIS  
COLORES ESPECIALES  
SPECIAL COLORS

XX=

00

23 / 47 / 48

PÁG. 8

Platinum 60 cuba al centro  
Platinum 60 centered sink

(60x43x13 cm)

79301xx2C

190 €

333 €

380 €

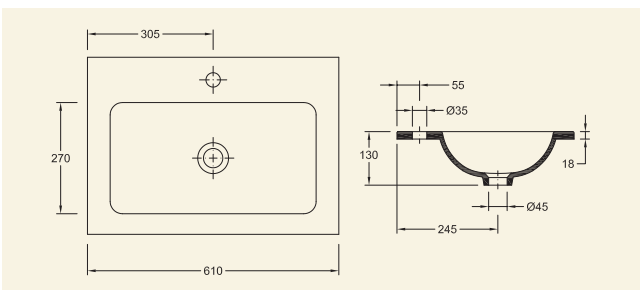

INOX POLIDO  
ACERO INOXIDABLE PULIDO  
POLISHED STAINLESS STEEL

REF

### SUPORE FIXAÇÃO COM TOALHEIROS LATERAIS

Soporte de fijación con toalleros laterales  
Fixing supports with side towel rails

204 €

55181002

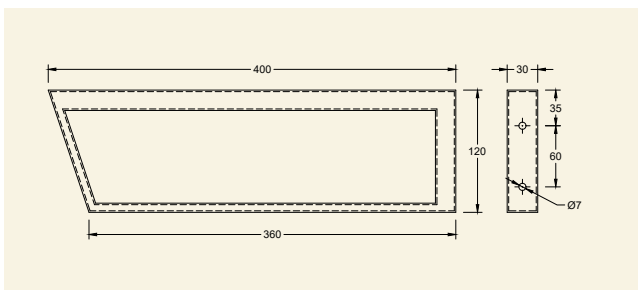

INOX POLIDO  
ACERO INOXIDABLE PULIDO  
POLISHED STAINLESS STEEL

REF

### TOALHEIROS PLATINIUM

Toalleros Platinum  
Platinum towel rails

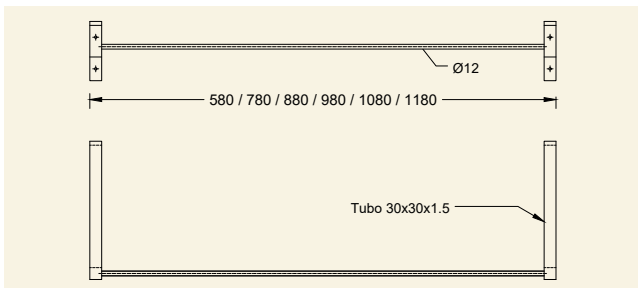

Para serem montados nos suportes 55181100  
Para montaje en los suportes 55181100  
To be installed on the supports 55181100

69 €	55174120	120
69 €	55174110	110
69 €	55174100	100
67 €	55174090	90
67 €	55174080	80
67 €	55174060	60

INOX POLIDO  
ACERO INOXIDABLE PULIDO  
POLISHED STAINLESS STEEL

REF

### SUPORES DE FIXAÇÃO

Suportes de fijación  
Fixing brackets

148 €

55181100

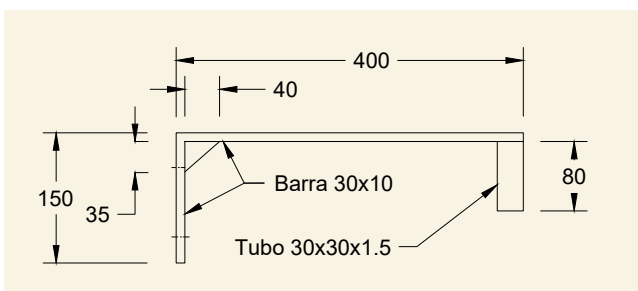

**PORTO (C/ FURO TORNEIRA)**

REF

(c/ agujero grifo)  
(w/ tap hole)

(80x44x10 cm)

79621xx2C

BRANCO  
BLANCO  
WHITE

XX= 00

259 €

CORES STANDARD  
COLORES STANDARD  
STANDARD COLORS

23 / 47 / 48

454 €

CORES ESPECIAIS  
COLORES ESPECIALES  
SPECIAL COLORS

PÁG. 8

518 €

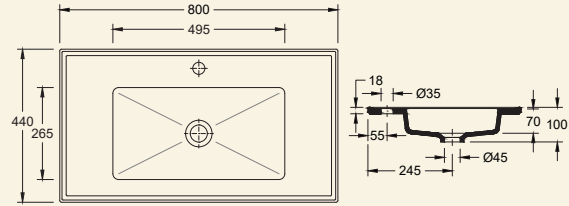

**RAFAEL DUPLA PIA**

REF

Rafael c/ dos cubas  
Rafael w/ double sink

(120x46x12 cm)

79842xx2C

BRANCO  
BLANCO  
WHITE

XX= 00

466 €

CORES STANDARD  
COLORES STANDARD  
STANDARD COLORS

23 / 47 / 48

816 €

CORES ESPECIAIS  
COLORES ESPECIALES  
SPECIAL COLORS

PÁG. 8

932 €

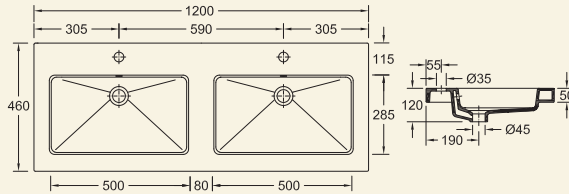

**RAFAEL**

REF



BRANCO  
BLANCO  
WHITE

XX= 00

466 €

CORES STANDARD  
COLORES STANDARD  
STANDARD COLORS

23 / 47 / 48

816 €

CORES ESPECIAIS  
COLORES ESPECIALES  
SPECIAL COLORS

PÁG. 8

932 €

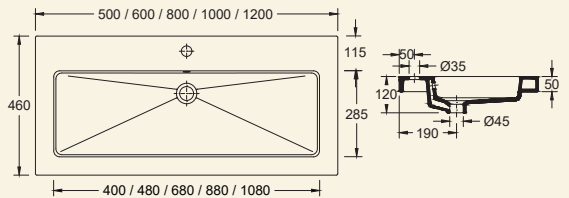

120 (120x46x12 cm)

79831xx2C

466 €

816 €

932 €

100 (100x46x12 cm)

79821xx2C

270 €

472 €

539 €

80 (80x46x12 cm)

79811xx2C

202 €

354 €

403 €

60 (60x46x12 cm)

79801xx2C

173 €

303 €

345 €

50 (50x46x12 cm)

79861xx2C

173 €



BRANCO BLANCO WHITE	CORES STANDARD COLORES STANDARD STANDARD COLORS	CORES ESPECIAIS COLORES ESPECIALES SPECIAL COLORS	REF	RAFAEL PIO CENTRAL 50CM
XX= 00	23 / 47 / 48	PÁG. 8		Con cuba al centro 50cm With centered sink 50cm
379 €	663 €	757 €	79851xx2C	(100x46x12 cm)

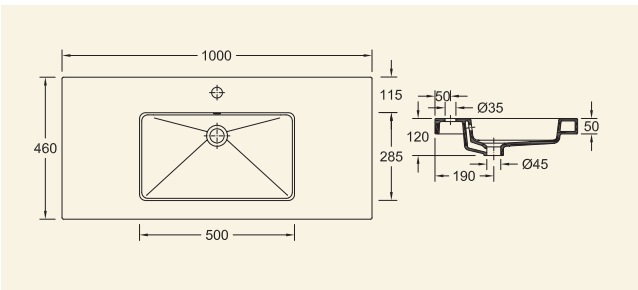

INOX POLIDO ACERO INOXIDABLE PULIDO POLISHED STAINLESS STEEL	REF	SUPORTES FIXAÇÃO
		Soportes de fijación Fixing supports
204 €	55181002	

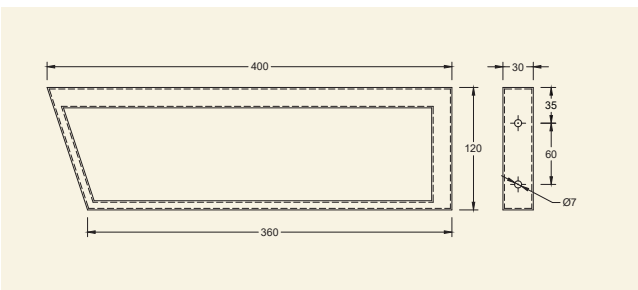

INOX POLIDO ACERO INOXIDABLE PULIDO POLISHED STAINLESS STEEL	REF	ESTRUTURAS P/ LAVATÓRIOS RAFAEL
		Estructuras para lavabos Rafael Structures for Rafael washbasins

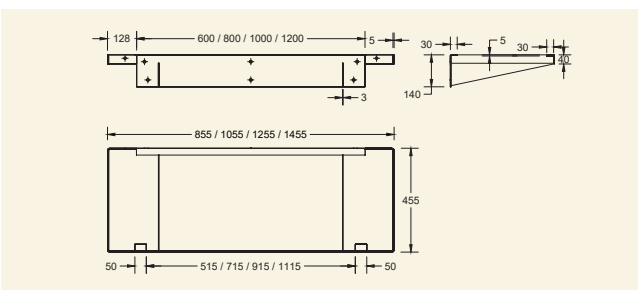

549 €	55181009	120
549 €	55181007	100
512 €	55181005	80
477 €	55181003	60



**PRATELEIRAS P/ LAVATÓRIOS RAFAEL**

REF

INOX POLIDO  
ACERO INOXIDABLE PULIDO  
POLISHED STAINLESS STEEL

Estantes para lavabos Rafael  
Shelves for Rafael washbasins

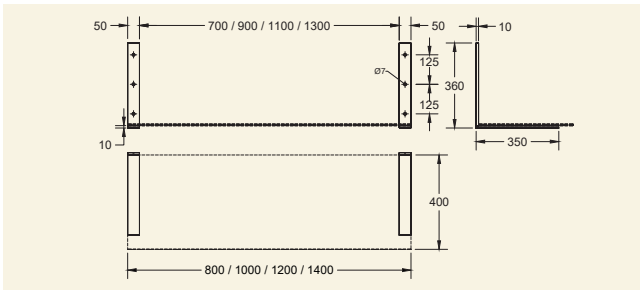

120	55181010	275 €
100	55181008	249 €
80	55181006	224 €
60	55181004	197 €

**APOLO**

REF

BRANCO  
BLANCO  
WHITE

CORES STANDARD  
COLORES STANDARD  
STANDARD COLORS

CORES ESPECIAIS  
COLORES ESPECIALES  
SPECIAL COLORS

XX=

00

23 / 47 / 48

PÁG. 8

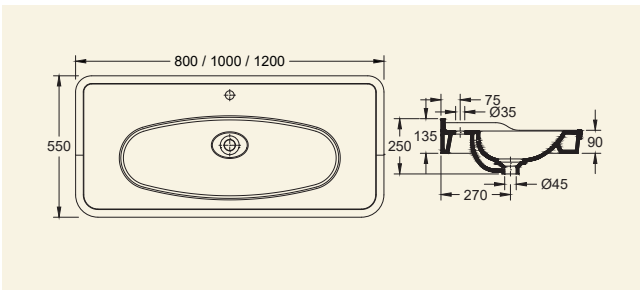

120 (120x55x25 cm)	78331xx2C	1.008 €	1.763 €	2.015 €
100 (100x55x25 cm)	78321xx2C	688 €	1.205 €	1.376 €
80 (80x55x25 cm)	78311xx2C	427 €	748 €	854 €

**ESTRUTURAS APOLO**

REF

CROMADO  
CROMO  
CHROME

Estructuras Apolo  
Consoles Apolo

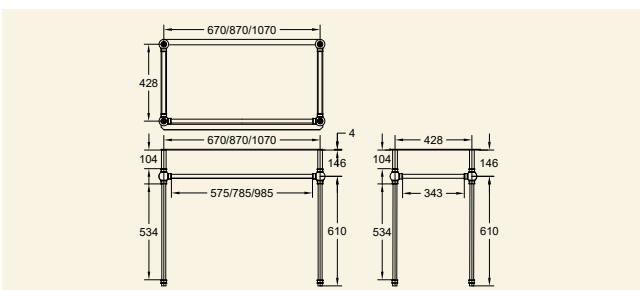

120	50700042	1.668 €
100	50700032	1.440 €
80	50700022	1.440 €

BRANCO BLANCO WHITE	CORES STANDARD COLORES STANDARD STANDARD COLORS	CORES ESPECIAIS COLORES ESPECIALES SPECIAL COLORS	REF	VÁLVULA VCC C/ TAMPA CERÂMICA APOLO
XX= 00	23 / 47 / 48	PÁG. 8		Válvula VCC con tapa cerámica Apolo VCC waste with ceramic cover Apolo
92 €	125 €	157 €	55115002xx	



BRANCO BLANCO WHITE	CORES STANDARD COLORES STANDARD STANDARD COLORS	CORES ESPECIAIS COLORES ESPECIALES SPECIAL COLORS	REF	NEOCLÁSSICO DE EMBUTIR REDONDO
XX= 00	23 / 47 / 48	PÁG. 8		Neoclássico sobre encimera redondo Embedded Neoclássico round
312 €	547 €	624 €	16387xx2C	(Ø 45 cm)

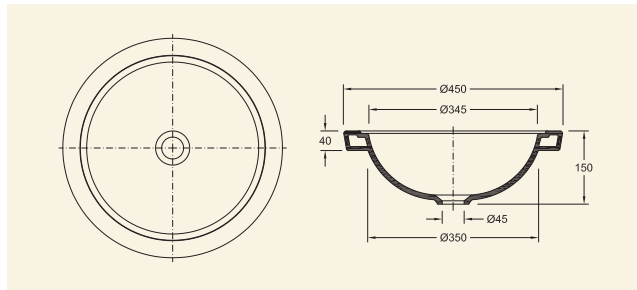

BRANCO BLANCO WHITE	CORES STANDARD COLORES STANDARD STANDARD COLORS	CORES ESPECIAIS COLORES ESPECIALES SPECIAL COLORS	REF	SERRAS
XX= 00	23 / 47 / 48	PÁG. 8		
225 €	394 €	449 €	78840xx2C	(Ø 40 cm)

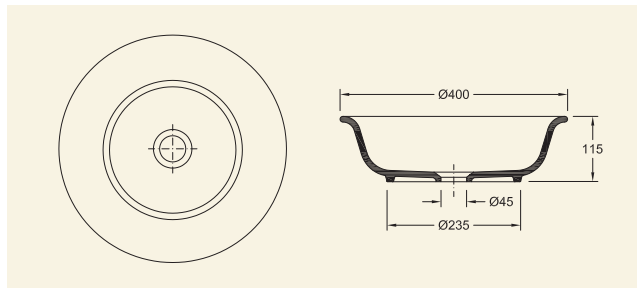

BRANCO BLANCO WHITE	REF	SABONETEIRA SERRAS
XX= 00		Jabonera Serras Soap tray Serras
26 €	21400xx2	

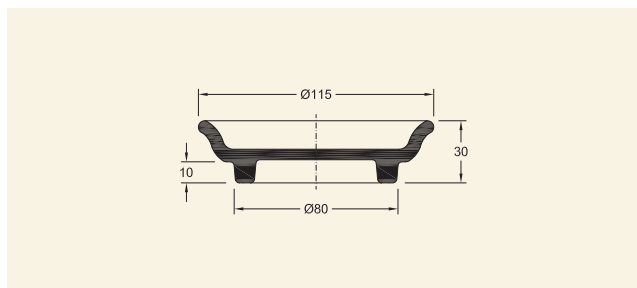

**COPO SERRAS**

REF

BRANCO  
BLANCO  
WHITE

Vaso Serras  
Cup Serras

XX= 00

21600xx2

32 €

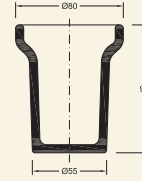

**ESTRUTURA DE PÉ (LAVATÓRIO EMBUTIR E SERRAS)**

REF

BRANCO  
BLANCO  
WHITE

PRETO  
NEGRO  
BLACK

Estrutura de pie (lavabos sobre encimera y Serras)  
Console (embedded and Serras washbasins)

X = 1

x = 3

5518201xBR

393 €

393 €

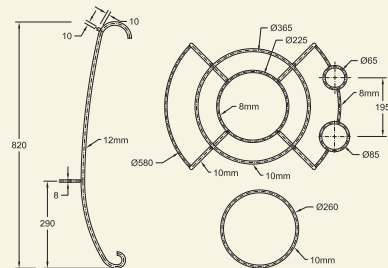
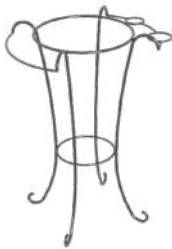

**ESTRUTURA SUSPENSA (LAVATÓRIO EMBUTIR E SERRAS)**

REF

BRANCO  
BLANCO  
WHITE

PRETO  
NEGRO  
BLACK

Estrutura suspendida (lavabos sobre encimera y Serras)  
Wall-hung Console (embedded and Serras washbasins)

X = 1

x = 3

5518203x

393 €

393 €

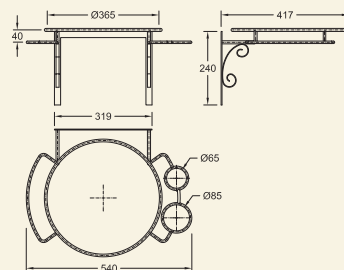

BRANCO BLANCO WHITE	CORES STANDARD COLORES STANDARD STANDARD COLORS	CORES ESPECIAIS COLORES ESPECIALES SPECIAL COLORS	REF	NEOCLÁSSICO RETANGULAR DE EMBUTIR
XX= 00	23 / 47 / 48	PÁG. 8		Neoclássico sobre encimera retangular Neoclássico embedded rectangular
312 €	547 €	624 €	16381xx2C	(60x46x4 cm)

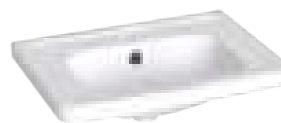
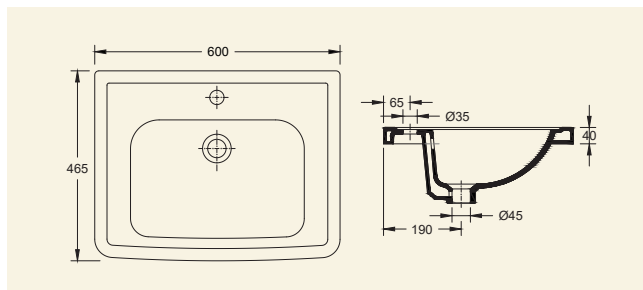

CROMADO CROMO CHROME	REF	ESTRUTURA PARA LAVATÓRIO RETANGULAR DE EMBUTIR
444 €	55182000	Estructura de lavabo retangular sobre encimera Console for embedded rectangular washbasin

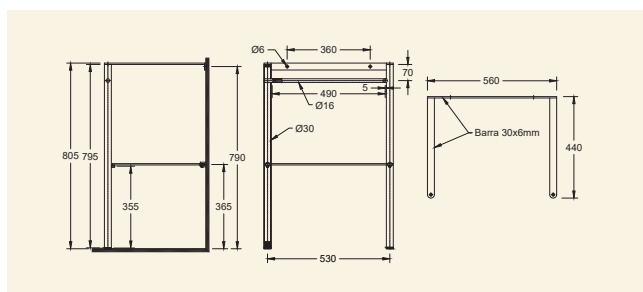

BRANCO BLANCO WHITE	CORES STANDARD COLORES STANDARD STANDARD COLORS	CORES ESPECIAIS COLORES ESPECIALES SPECIAL COLORS	REF	EGG COLUNA INTEGRADA
XX= 00	23 / 47 / 48	PÁG. 8		EGG columna EGG with integrated pedestal
1.025 €	1.794 €	2.050 €	39881xx2C	(48x52x90 cm)

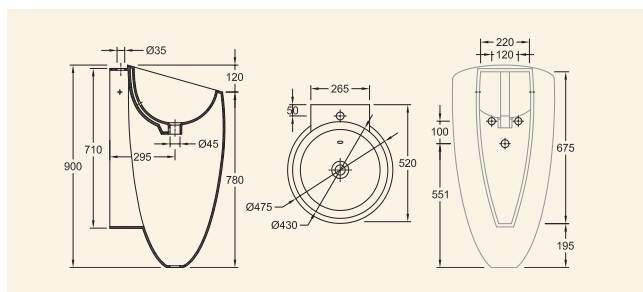

**KOBE (COM SAÍDA INFERIOR)**

REF

BRANCO  
BLANCO  
WHITE

CORES STANDARD  
COLORES STANDARD  
STANDARD COLORS

CORES ESPECIAIS  
COLORES ESPECIALES  
SPECIAL COLORS

Kobe (con salida inferior)  
Kobe (with bottom outlet)  
(Ø 45x82 cm)

79910xx2C

XX=

00

23 / 47 / 48

PÁG. 8

855 €

1.497 €

1.709 €

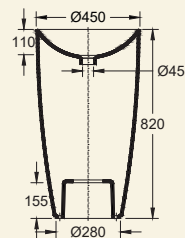

**KOBE (COM SAÍDA LATERAL)**

Kobe (con salida lateral)  
Kobe (with side outlet)  
(Ø 45x82 cm)

79911xx2C

855 €

1.497 €

1.709 €

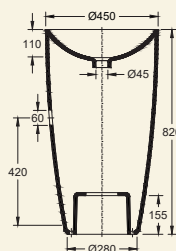

**RUBENS**

REF

BRANCO  
BLANCO  
WHITE

CORES STANDARD  
COLORES STANDARD  
STANDARD COLORS

CORES ESPECIAIS  
COLORES ESPECIALES  
SPECIAL COLORS

(Ø 40x44 cm)

79900xx2C

XX=

00

23 / 47 / 48

PÁG. 8

391 €

685 €

782 €

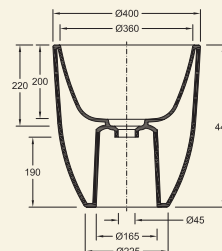

BRANCO BLANCO WHITE	PRETO NEGRO BLACK	REF	AVIZ
XX= 00	48		

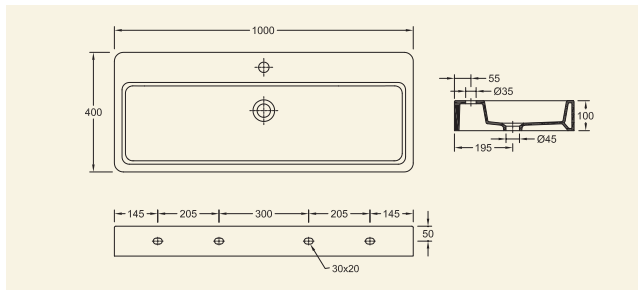

303 €	531 €	79741xx2C	100 (100x40x10 cm)
-------	-------	-----------	--------------------

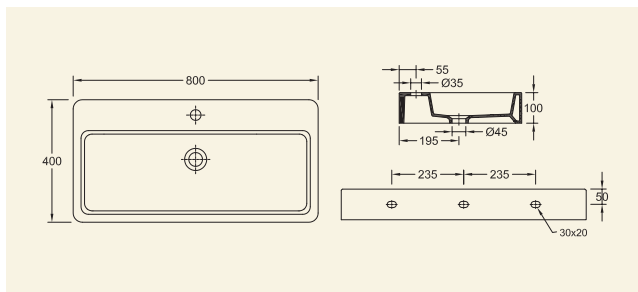

228 €	400 €	79721xx2C	80 (80x40x10 cm)
-------	-------	-----------	------------------

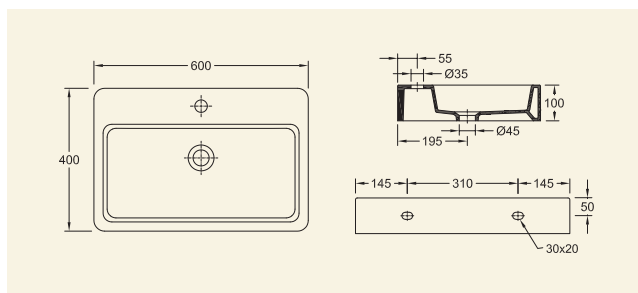

178 €	311 €	79701xx2C	60 (60x40x10 cm)
-------	-------	-----------	------------------



ONE LINE

REF

BRANCO  
BLANCO  
WHITE

CORES STANDARD  
COLORES STANDARD  
STANDARD COLORS

CORES ESPECIAIS  
COLORES ESPECIALES  
SPECIAL COLORS

XX= 00

23 / 47 / 48

PÁG. 8

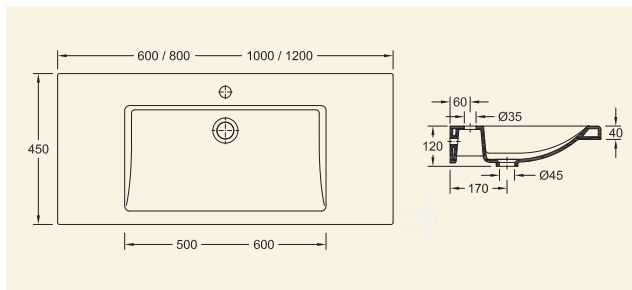

(120x45x12 cm) 120	40331xx2C	366 €	641 €	732 €
(100x45x12 cm) 100	40321xx2C	290 €	508 €	580 €
(90x45x12 cm) 90	40361xx2C	257 €	450 €	513 €
(80x45x12 cm) 80	40311xx2C	228 €	400 €	456 €
(70x45x12 cm) 70	40341xx2C	203 €	354 €	405 €
(60x45x12 cm) 60	40301xx2C	178 €	311 €	355 €

TOALHEIROS ONE LINE

REF

INOX POLIDO  
ACERO INOXIDABLE PULIDO  
POLISHED STAINLESS STEEL

PRETO  
NEGRO  
BLACK

Toalleros ONE LINE  
Towel rails ONE LINE

X= 0

3

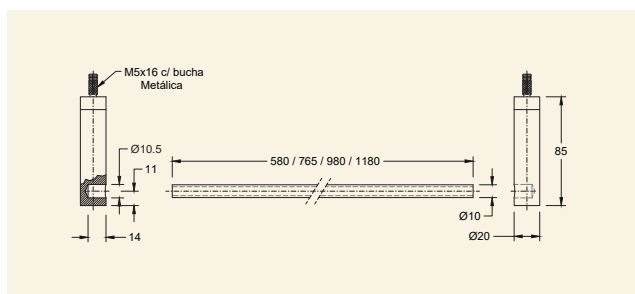

120	5517414x	80 €	120 €
100	5517413x	73 €	110 €
90	5517405x	73 €	110 €
80	5517408x	67 €	101 €
70	5517402x	67 €	101 €
60	5517407x	67 €	101 €



BRANCO  
BLANCO  
WHITE

REF

GALLERY

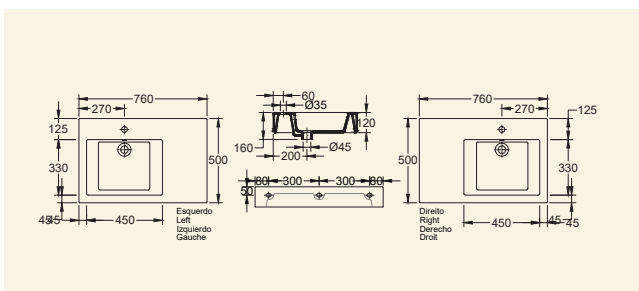

354 €

78821xx2C

Direito  
Derecho  
Right  
(76x50x12 cm)

354 €

78831xx2C

Esquerdo  
Izquierdo  
Left  
(76x50x12 cm)

INOX POLIDO  
ACERO INOXIDABLE PULIDO  
POLISHED STAINLESS STEEL

REF

TOALHEIRO LATERAL

53 €

55174010

Toallero lateral  
Side towel rail

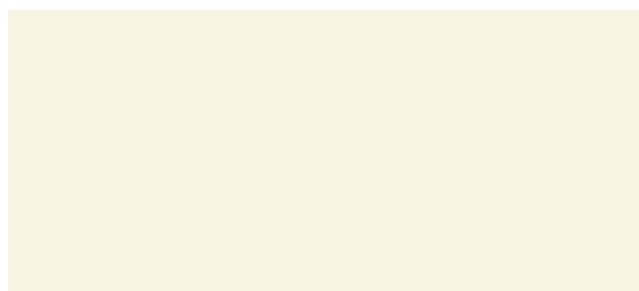

INOX POLIDO  
ACERO INOXIDABLE PULIDO  
POLISHED STAINLESS STEEL

REF

TOALHEIRO FRONTAL 72 CM

73 €

55174030

Toallero frontal 72 cm  
Frontal towel rail 72 cm

INOX POLIDO  
ACERO INOXIDABLE PULIDO  
POLISHED STAINLESS STEEL

REF

TOALHEIRO FRONTAL 53 CM

53 €

55174040

Toallero frontal 53 cm  
Frontal towel rail 53 cm

BRANCO  
BLANCO  
WHITE

PRETO  
NEGRO  
BLACK

REF

RECIFE PLUS

XX= 00

104 €

182 €

78761xx2C

(45x45x10 cm)

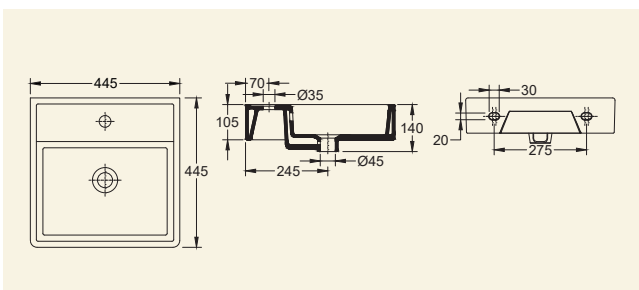

ISIS

REF

BRANCO  
BLANCO  
WHITE

XX= 00

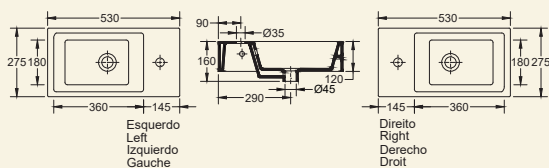

Esquerdo  
Izquierdo  
Left

78812xx2C

178 €

(53x28x12 cm)

Direito  
Derecho  
Right

78813xx2C

178 €

(53x28x12 cm)

EROS

REF

BRANCO  
BLANCO  
WHITE

XX= 00

(32x32x11 cm)

18851xx2C

76 €

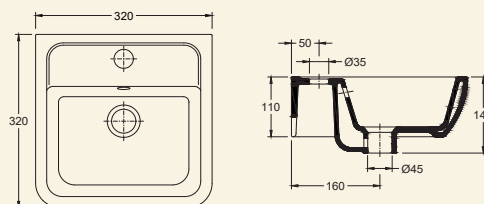

VÉNIUS

REF

BRANCO  
BLANCO  
WHITE

XX= 00

Torneira Esquerda  
Grifo Izquierdo  
Left Tap Hole

18862xx2C

102 €

(44x36x10 cm)

Torneira Direita  
Grifo Derecho  
Right Tap Hole

18863xx2C

102 €

(44x36x10 cm)

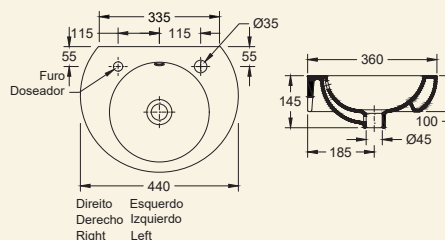

BRANCO  
BLANCO  
WHITE

REF

CEUTA

XX= 00

102 €

18801xx2C

(43x30x10 cm)

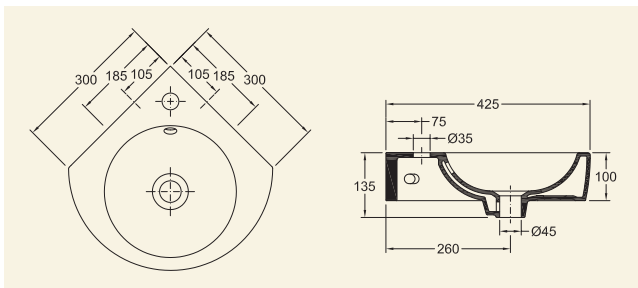

INOX POLIDO  
ACERO INOXIDABLE PULIDO  
POLISHED STAINLESS STEEL

REF

TOALHEIRO CEUTA

60 €

55174000

Toallero Ceuta  
Towel rail Ceuta



BRANCO  
BLANCO  
WHITE

REF

LAVA-MÃOS DE CANTO

XX= 00

Lava manos de rincon  
Corner hand washbasin

90 €

18307xx2C

(46x36x10 cm)

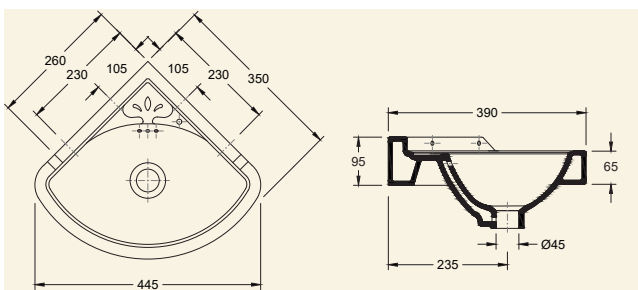

BRANCO  
BLANCO  
WHITE

REF

LAVA-MÃOS

XX= 00

Lava manos  
Hand washbasin

38 €

12361xx2C

(45x35x17 cm)

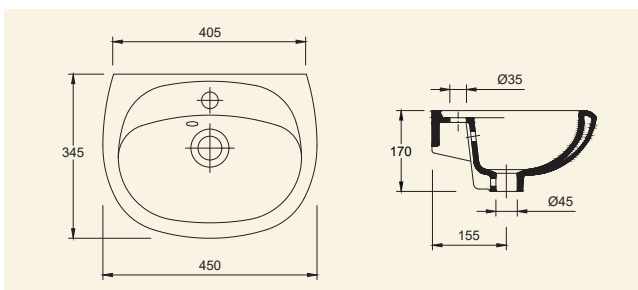

AVIZ V4

REF

BRANCO  
BLANCO  
WHITE

CORES STANDARD  
COLORES STANDARD  
STANDARD COLORS

CORES ESPECIAIS  
COLORES ESPECIALES  
SPECIAL COLORS

XX=

00

23 / 47 / 48

PÁG. 8

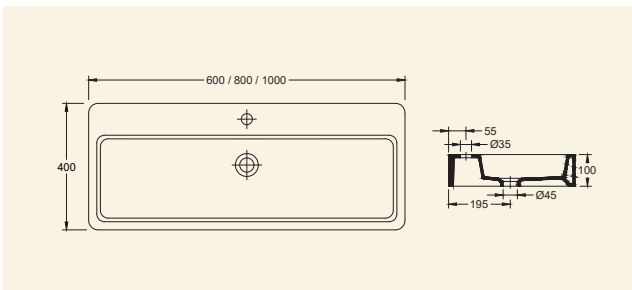

100 (100x40x10 cm)	79744xx2C	294 €	515 €	587 €
80 (80x40x10 cm)	79724xx2C	220 €	386 €	440 €
60 (60x40x10 cm)	79704xx2C	172 €	301 €	343 €

BARI

REF

BRANCO  
BLANCO  
WHITE

CORES STANDARD  
COLORES STANDARD  
STANDARD COLORS

CORES ESPECIAIS  
COLORES ESPECIALES  
SPECIAL COLORS

XX=

00

23 / 47 / 48

PÁG. 8

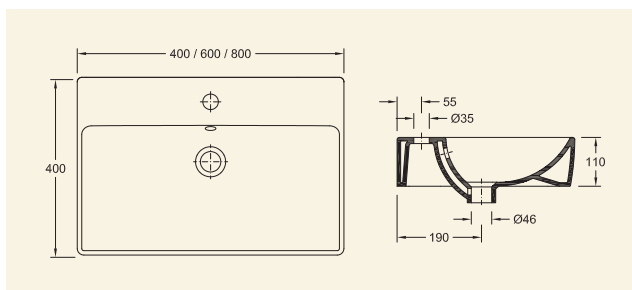

80 (80x40x11 cm)	79441xx2C	257 €	450 €	513 €
60 (60x40x11 cm)	79431xx2C	209 €	365 €	417 €
50 (50x40x11 cm)	79421xx2C	184 €	322 €	368 €
40 (40x40x11 cm)	79411xx2C	159 €	279 €	318 €

VAN GOGH

REF

BRANCO  
BLANCO  
WHITE

CORES STANDARD  
COLORES STANDARD  
STANDARD COLORS

CORES ESPECIAIS  
COLORES ESPECIALES  
SPECIAL COLORS

XX=

00

23 / 47 / 48

PÁG. 8

(60x41x10 cm)

78867xx2C

172 €

301 €

343 €

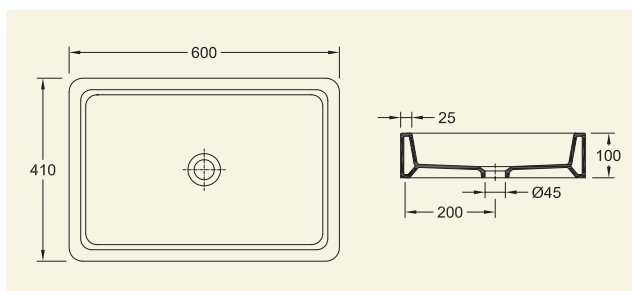

BRANCO BLANCO WHITE      CORES STANDARD COLORES STANDARD STANDARD COLORS      CORES ESPECIAIS COLORES ESPECIALES SPECIAL COLORS      REF      CHAGALL

XX= 00      23 / 47 / 48      PÁG. 8

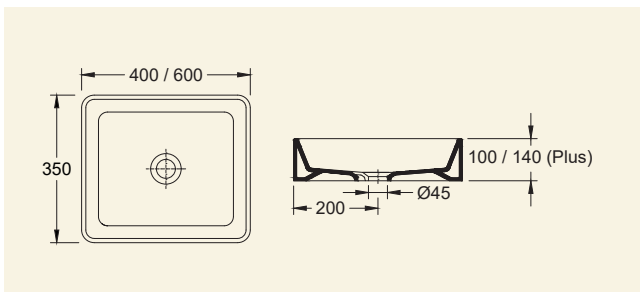

190 €	333 €	380 €	78850xx2C	(40x35x10 cm) 40
257 €	450 €	513 €	78860xx2C	(60x35x10 cm) 60
306 €	536 €	612 €	78865xx2C	(60x35x14 cm) Plus

BRANCO BLANCO WHITE      REF      ÍSIS DE POUSAR

XX= 00

Ísis Sobre Mueble  
Isis Standing

178 €	78811xx2C	(53x28x12 cm)
-------	-----------	---------------

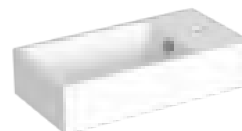
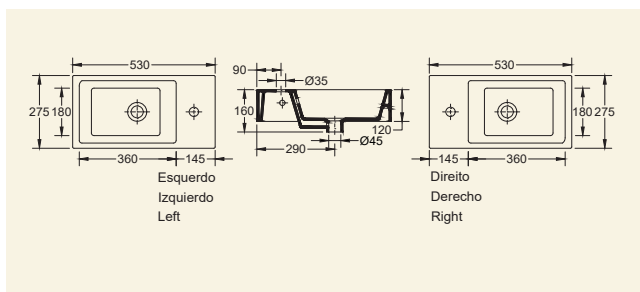

BRANCO BLANCO WHITE      REF      MALMO

XX= 00

253 €	78871xx2C	(54x30x12 cm)
-------	-----------	---------------

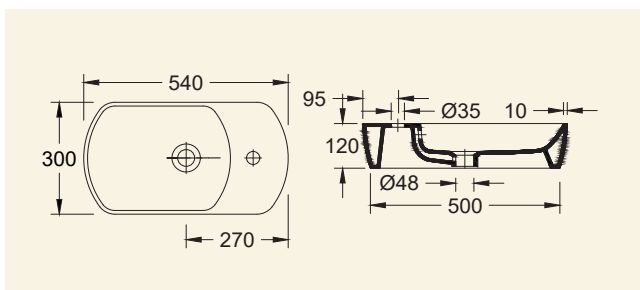

**PICASSO**

REF

BRANCO  
BLANCO  
WHITE

CORES STANDARD  
COLORES STANDARD  
STANDARD COLORS

CORES ESPECIAIS  
COLORES ESPECIALES  
SPECIAL COLORS

XX=

00

23 / 47 / 48

PÁG. 8

(50x30x13 cm)

78357xx2K

327 €

572 €

654 €

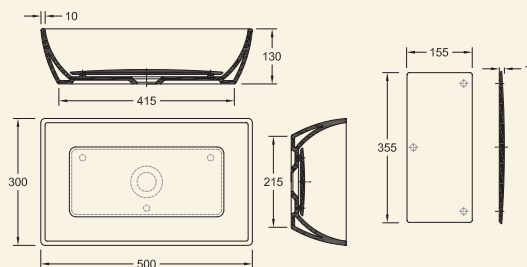
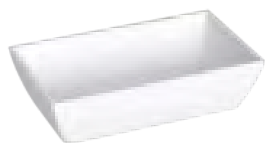

**DAYTONA**

REF

BRANCO  
BLANCO  
WHITE

CORES STANDARD  
COLORES STANDARD  
STANDARD COLORS

CORES ESPECIAIS  
COLORES ESPECIALES  
SPECIAL COLORS

XX=

00

23 / 47 / 48

PÁG. 8

(40x40x10 cm)

18817xx2C

135 €

236 €

270 €

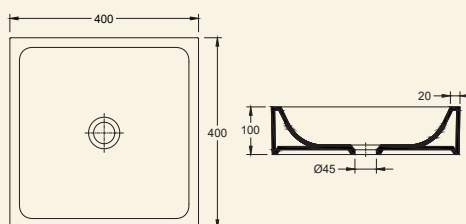

**MACAU**

REF

BRANCO  
BLANCO  
WHITE

CORES STANDARD  
COLORES STANDARD  
STANDARD COLORS

CORES ESPECIAIS  
COLORES ESPECIALES  
SPECIAL COLORS

XX=

00

23 / 47 / 48

PÁG. 8

(41x41x10 cm)

78857xx2C

144 €

252 €

288 €

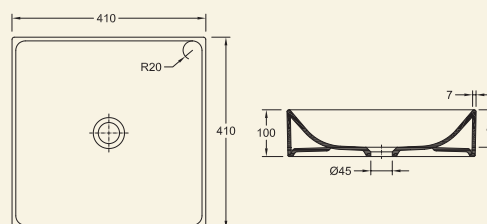

BRANCO BLANCO WHITE	CORES STANDARD COLORES STANDARD STANDARD COLORS	CORES ESPECIAIS COLORES ESPECIALES SPECIAL COLORS	REF	RECIFE PLUS V4
---------------------------	---	---	-----	----------------

XX= 00 23 / 47 / 48 PÁG. 8

138 € 242 € 276 € 78764xx2C (45x45x10 cm)

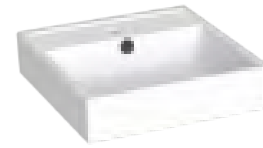
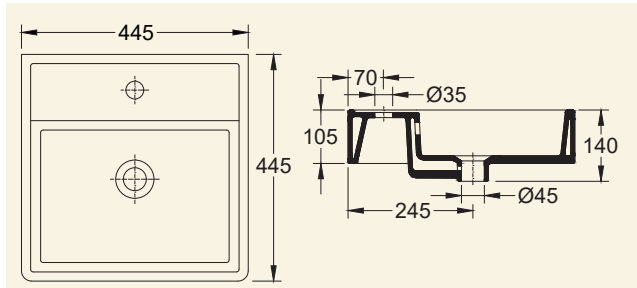

BRANCO BLANCO WHITE	CORES STANDARD COLORES STANDARD STANDARD COLORS	CORES ESPECIAIS COLORES ESPECIALES SPECIAL COLORS	REF	RIO
---------------------------	---	---	-----	-----

XX= 00 23 / 47 / 48 PÁG. 8

121 € 212 € 242 € 18711xx2C (45x45x12 cm)

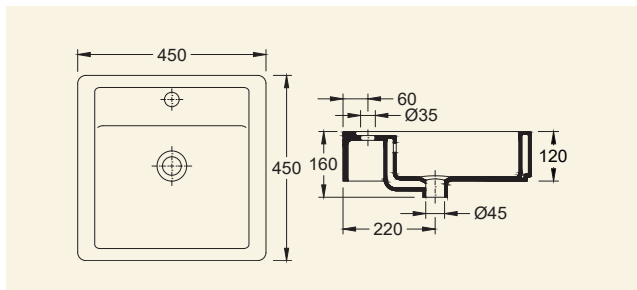

BRANCO BLANCO WHITE	CORES STANDARD COLORES STANDARD STANDARD COLORS	CORES ESPECIAIS COLORES ESPECIALES SPECIAL COLORS	REF	EGG
---------------------------	---	---	-----	-----

XX= 00 23 / 47 / 48 PÁG. 8

168 € 295 € 336 € 39357xx2C (50x38x12 cm)

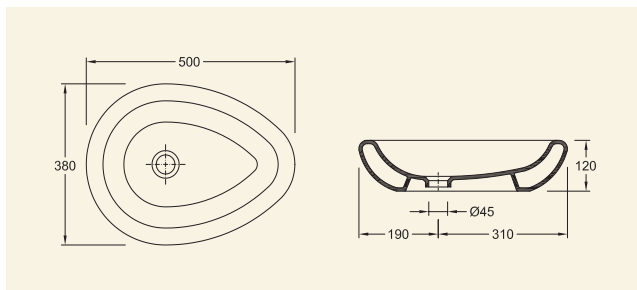

BRANCO BLANCO WHITE	CORES STANDARD COLORES STANDARD STANDARD COLORS	CORES ESPECIAIS COLORES ESPECIALES SPECIAL COLORS	REF	SAVOY
---------------------------	---	---	-----	-------

XX= 00 23 / 47 / 48 PÁG. 8

314 € 550 € 628 € 18890xx2C (50x30x13 cm)

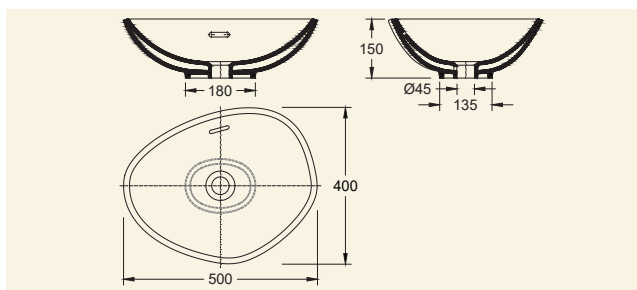

**ONE SLIM**

REF

BRANCO  
BLANCO  
WHITE

CORES STANDARD  
COLORES **STANDARD**  
STANDARD COLORS

CORES ESPECIAIS  
COLORES **ESPECIALES**  
SPECIAL COLORS

XX=

00

23 / 47 / 48

PÁG. 8

(47x35x13 cm)

40357xx2C

179 €

313 €

357 €

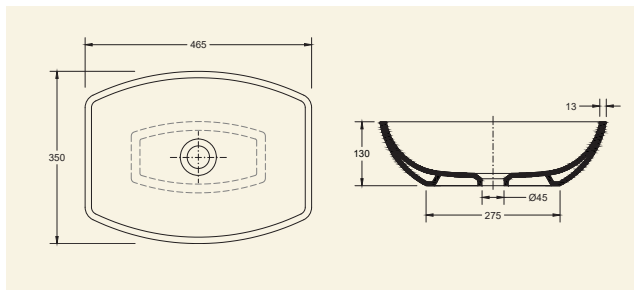

**ONE BOLD**

REF

BRANCO  
BLANCO  
WHITE

CORES STANDARD  
COLORES **STANDARD**  
STANDARD COLORS

CORES ESPECIAIS  
COLORES **ESPECIALES**  
SPECIAL COLORS

XX=

00

23 / 47 / 48

PÁG. 8

(51x39x13 cm)

40350xx2C

179 €

313 €

357 €

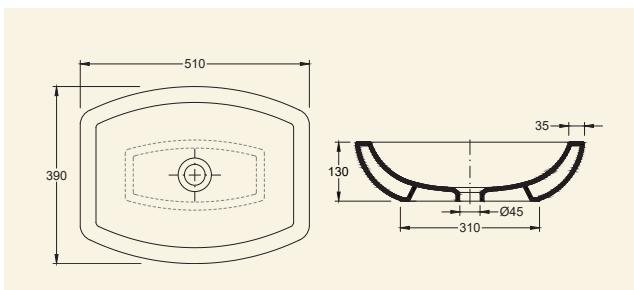

**MALIBU**

REF

BRANCO  
BLANCO  
WHITE

CORES STANDARD  
COLORES **STANDARD**  
STANDARD COLORS

CORES ESPECIAIS  
COLORES **ESPECIALES**  
SPECIAL COLORS

XX=

00

23 / 47 / 48

PÁG. 8

(Ø42x13 cm)

78737xx2C

173 €

303 €

345 €

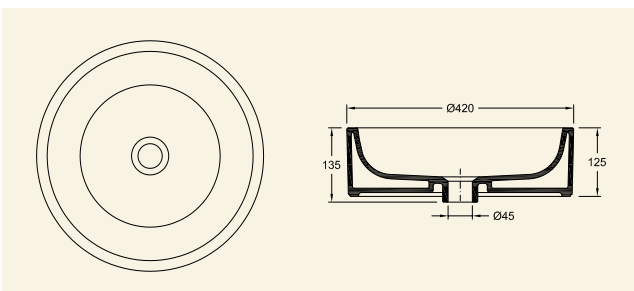



BRANCO BLANCO WHITE	CORES STANDARD COLORES <b>STANDARD</b> STANDARD COLORS	CORES ESPECIAIS COLORES <b>ESPECIALES</b> SPECIAL COLORS	REF	TAITI
---------------------------	--	--	-----	-------

XX= 00 23 / 47 / 48 PÁG. 8

196 €	343 €	391 €	78731xx2C	(Ø 42x13 cm)
-------	-------	-------	-----------	--------------

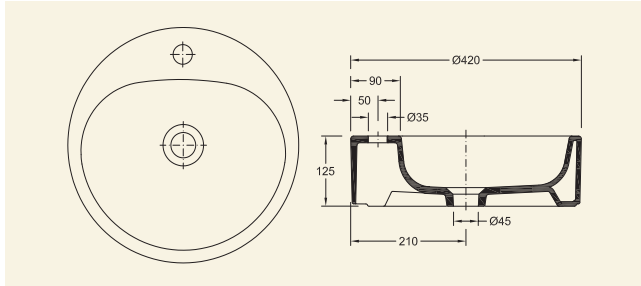

BRANCO BLANCO WHITE	CORES STANDARD COLORES <b>STANDARD</b> STANDARD COLORS	CORES ESPECIAIS COLORES <b>ESPECIALES</b> SPECIAL COLORS	REF	ZEN
---------------------------	--	--	-----	-----

XX= 00 23 / 47 / 48 PÁG. 8

333 €	582 €	665 €	79920xx2C	(Ø 44x21 cm)
-------	-------	-------	-----------	--------------

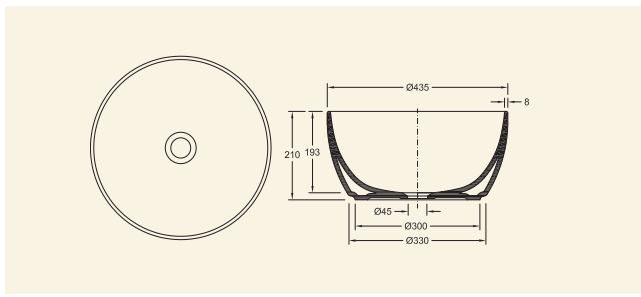

BRANCO BLANCO WHITE	CORES STANDARD COLORES <b>STANDARD</b> STANDARD COLORS	CORES ESPECIAIS COLORES <b>ESPECIALES</b> SPECIAL COLORS	REF	BOSTON
---------------------------	--	--	-----	--------

XX= 00 23 / 47 / 48 PÁG. 8

101 €	176 €	201 €	18717xx2C	(Ø 41x16 cm)
-------	-------	-------	-----------	--------------

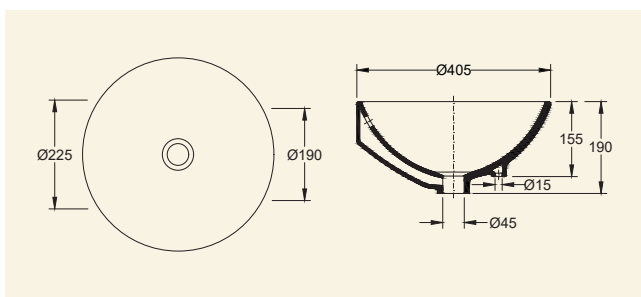

**URANO**

REF

BRANCO  
BLANCO  
WHITE

CORES STANDARD  
COLORES STANDARD  
STANDARD COLORS

CORES ESPECIAIS  
COLORES ESPECIALES  
SPECIAL COLORS

XX= 00 23 / 47 / 48 PÁG. 8

(Ø45x10 cm)

18871xx2C

127 € 222 € 253 €

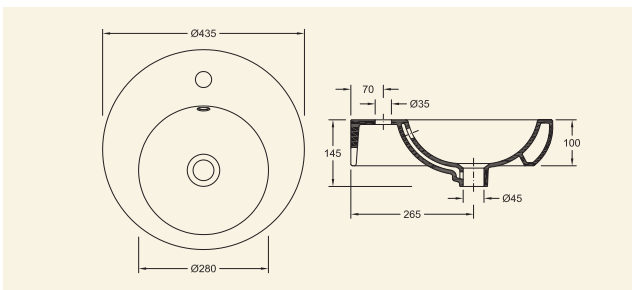

**DARK**

REF

BRANCO  
BLANCO  
WHITE

CORES STANDARD  
COLORES STANDARD  
STANDARD COLORS

CORES ESPECIAIS  
COLORES ESPECIALES  
SPECIAL COLORS

XX= 00 23 / 47 / 48 PÁG. 8

(Ø40x13 cm)

18797xx2C

163 € 285 € 325 €

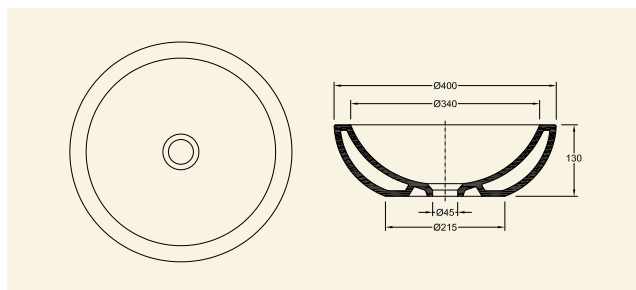

**TICIANO**

REF

BRANCO  
BLANCO  
WHITE

CORES STANDARD  
COLORES STANDARD  
STANDARD COLORS

CORES ESPECIAIS  
COLORES ESPECIALES  
SPECIAL COLORS

XX= 00 23 / 47 / 48 PÁG. 8

(45x33x13 cm)

78891xx2C

267 € 467 € 534 €

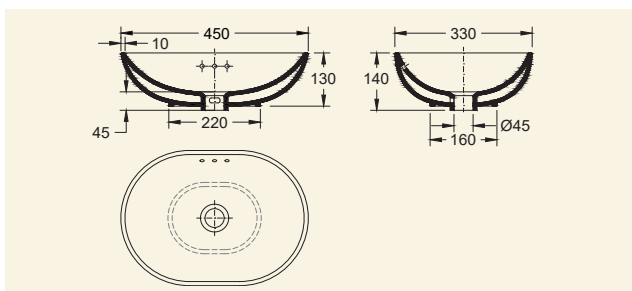

BRANCO BLANCO WHITE      CORES STANDARD COLORES STANDARD STANDARD COLORS      CORES ESPECIAIS COLORES ESPECIALES SPECIAL COLORS      REF      ATLANTA

XX= 00      23 / 47 / 48      PÁG. 8

115 €

202 €

230 €

18771xx2C

(55x45x15cm)

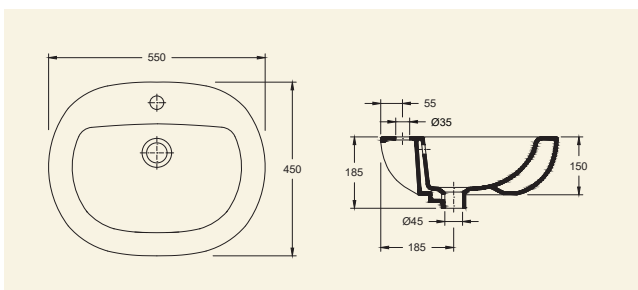

BRANCO BLANCO WHITE      REF      MIAMI

XX= 00

138 €

18701xx2C

(63x49x13 cm)

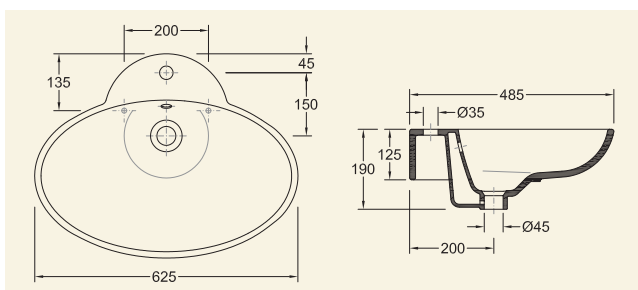

EMBUTIR | SOBRE ENCIMERA | EMBEDDED

BRANCO BLANCO WHITE      REF      GOA

XX= 00

102 €

78707xx2C

(Ø43x21 cm)

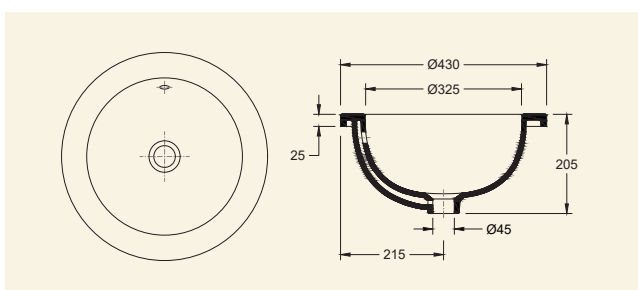

**MIRAMAR**

REF

BRANCO  
BLANCO  
WHITE

(57x50x22 cm)

18361xx2C

XX= 00

63 €

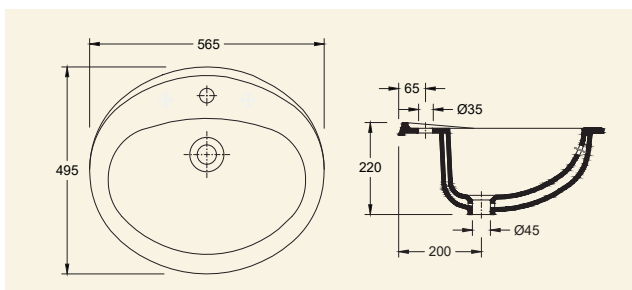

**MÓNACO**

REF

BRANCO  
BLANCO  
WHITE

(Ø41x21 cm)

18386xx2C

XX= 00

65 €

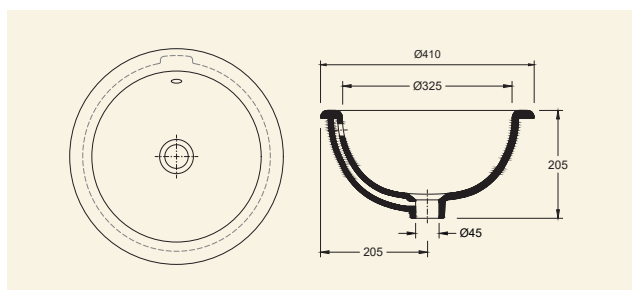

**PALM**

REF

BRANCO  
BLANCO  
WHITE

(Ø40x13 cm)

18807xx2C

XX= 00

152 €

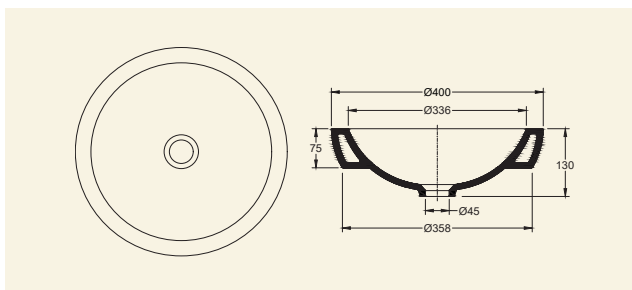

**OÁSIS C/ TORNEIRA AO CENTRO**

REF

BRANCO  
BLANCO  
WHITE

Oásis con grifo al centro  
Oásis with centered tap hole

(57x46x17 cm)

18841xx2C

XX= 00

140 €

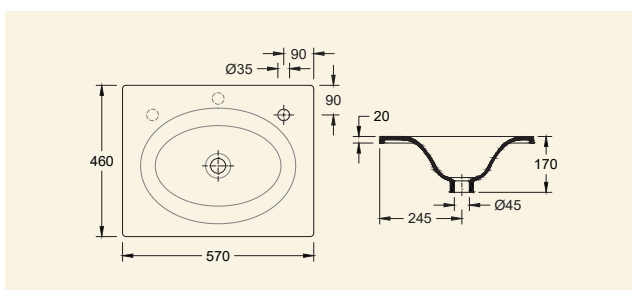

BRANCO  
BLANCO  
WHITEPRETO  
NEGRO  
BLACK

REF

BARI

XX= 00

148 €

258 €

18881xx2C

(50x35x14 cm)

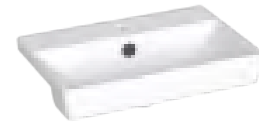
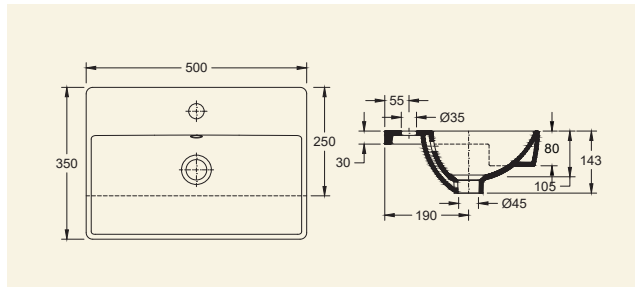
BRANCO  
BLANCO  
WHITE

REF

TORINO

XX= 00

159 €

18341xx2C

(67x51x20 cm)

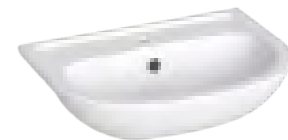
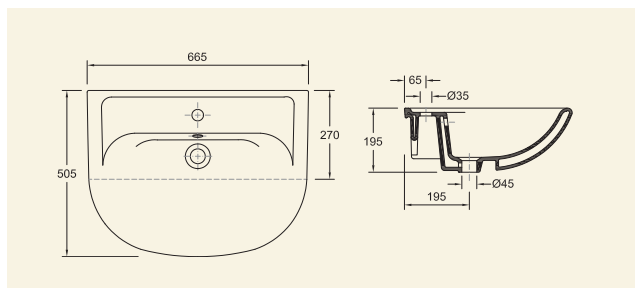
BRANCO  
BLANCO  
WHITE

REF

ROMA

XX= 00

75 €

18751xx2C

(50x42x17 cm)

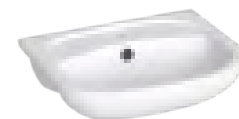
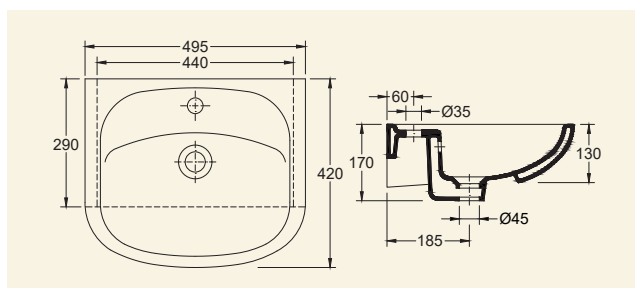

**OVAL**

REF

BRANCO  
BLANCO  
WHITE

XX= 00

(58x46x21 cm)

18327xx2C

55 €

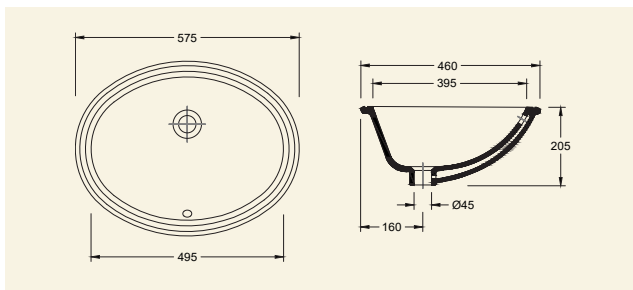

**DANÚBIO**

REF

BRANCO  
BLANCO  
WHITE

XX= 00

(53x42x19 cm)

18757xx2C

64 €

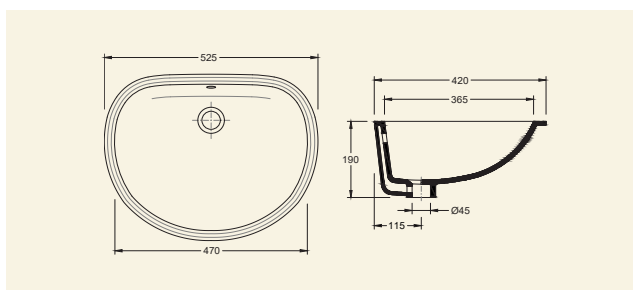
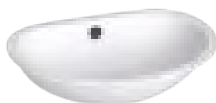

**NICE**

REF

BRANCO  
BLANCO  
WHITE

XX= 00

(Ø37x20 cm)

18381xx2C

76 €

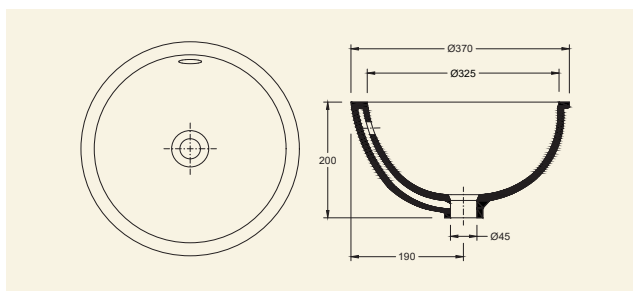

BRANCO  
BLANCO  
WHITE

REF

MISSOURI

XX= 00

71 €

18767xx2C

(54x42x18 cm)

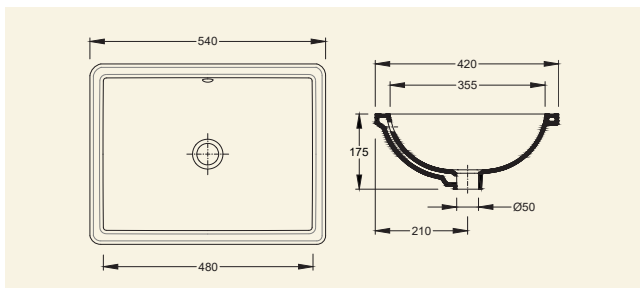

BRANCO  
BLANCO  
WHITE

CORES STANDARD  
COLORES STANDARD  
STANDARD COLORS

REF

TOLEDO

XX= 00

23 / 47 / 48

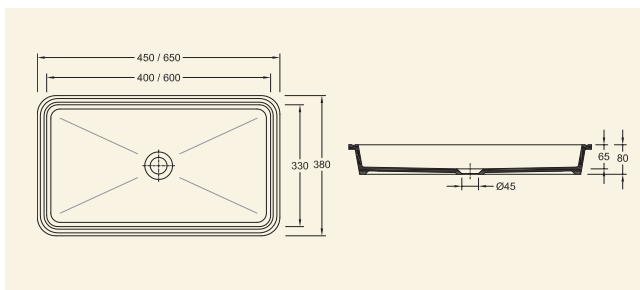

148 €

258 €

78868xx2C

(65x38x8 cm)

121 €

212 €

78848xx2C

(45x38x8 cm)



BRANCO  
BLANCO  
WHITE

CORES STANDARD  
COLORES STANDARD  
STANDARD COLORS

REF

TÂNGER

XX= 00

23 / 47 / 48

65 €

113 €

18777xx2C

(55x35x16 cm)

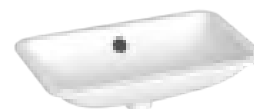
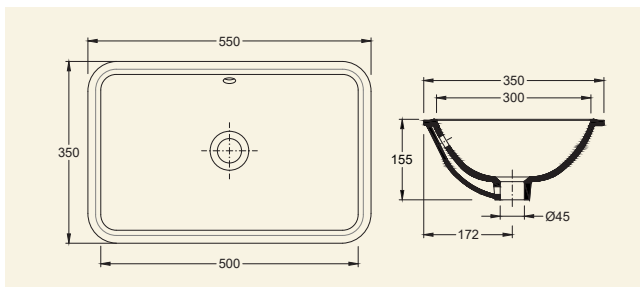

**TÂNGER S**

REF

BRANCO  
BLANCO  
WHITE

CORES STANDARD  
COLORES STANDARD  
STANDARD COLORS

XX=

00

23 / 47 / 48

(50x34x16 cm)

18775xx2C

65 €

113 €

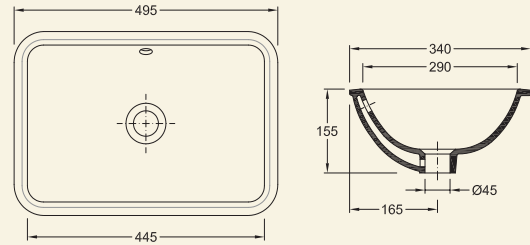

**DALI**

REF

BRANCO  
BLANCO  
WHITE

CORES STANDARD  
COLORES STANDARD  
STANDARD COLORS

XX=

00

23 / 47 / 48

(Ø47x18 cm)

18887xx2C

102 €

178 €

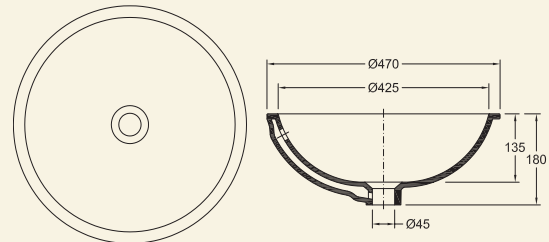





BRANCO BLANCO WHITE	CORES STANDARD COLORES STANDARD STANDARD COLORS	CORES ESPECIAIS COLORES ESPECIALES SPECIAL COLORS	REF	PLACA CERÂMICA P/LAVATÓRIO PICASSO
XX= 00	23 / 47 / 48	PÁG. 8		Plato en cerâmica para lavabo Picasso Ceramic cover for Washbasin Picasso (36x16x1 cm)
63 €	110 €	125 €	78358xx2	



BRANCO BLANCO WHITE	CORES STANDARD COLORES STANDARD STANDARD COLORS	CORES ESPECIAIS COLORES ESPECIALES SPECIAL COLORS	REF	RALO CERÂMICO (LAVATÓRIO RUBENS)
XX= 00	23 / 47 / 48	PÁG. 8		Desagüe cerámico (lavabo Rubens) Ceramic drain (washbasin Rubens) (36x16x1 cm)
25 €	43 €	49 €	20925xx2	



			REF	KIT FIXAÇÃO Nº1
				Kit de fijación nº1 Fixing kit nº1
5 €			55007001	



			REF	KIT FIXAÇÃO P/ LAV. 3 FUROS FIXAÇÃO
				Kit de fijación p/ lav. 3 orifício fijación Fixing kit for washbasins 3 fixation holes
5 €			55007320	



			REF	VÁLVULA CLIC-CLAC
				Válvula clic-clac Pop-up waste
20 €			55110022	



			REF	VÁLVULA CLIC-CLAC (KOBÉ)
				Válvula clic-clac (Kobe) Pop-up waste (Kobe)
22 €			55110042	



			REF	KIT DE DESCARGA (KOBÉ)
				Kit de descarga (Kobe) Discharge kit (Kobe)
41 €			55023052	



			REF	TUBO FLEXÍVEL DE DESCARGA (KOBÉ)
				Manguito de descarga (Kobe) Flush hose (Kobe)
10 €			55079000	



BRANCO BLANCO WHITE	CORES STANDARD COLORES STANDARD STANDARD COLORS	CORES ESPECIAIS COLORES ESPECIALES SPECIAL COLORS	REF	PRATELEIRA CERÂMICA P/ ESTRUTURA DE LAVATÓRIO SERRAS
XX= 00	23 / 47 / 48	PÁG. 8		Estante de cerâmica para estrutura de lavabo Serras Ceramic Shelf for Serras washbasin structure
58 €	102 €	115 €	21500xx2	



			REF	KIT FIXAÇÃO P/ LAVATÓRIOS DE ENCASTRAR
				Kit de fijación para lavabos de bajo encimera Fixing kit for built-embedded washbasins
21 €			55150110	

**ONOR**

REF

CRYSTAL WHITE

NEGRO ABSOLUTO  
ABSOLUTE BLACK

OUTRAS PEDRAS  
OTRAS PIEDRAS  
OTHER STONES

XX= 01

11

21 / 31 / 41 / 51 / 61

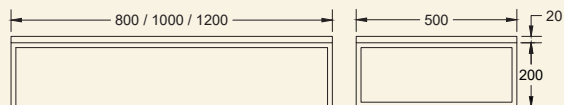
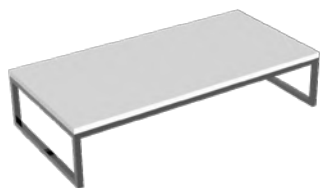

Size	REF	CRYSTAL WHITE	NEGRO ABSOLUTO ABSOLUTE BLACK	OUTRAS PEDRAS OTRAS PIEDRAS OTHER STONES
120 (120x50 cm)	5287xx23	662 €	1.085 €	1.180 €
100 (100x50 cm)	5287xx03	593 €	945 €	1.031 €
80 (80x50 cm)	5287xx83	512 €	805 €	880 €

**LENA**

REF

CRYSTAL WHITE

NEGRO ABSOLUTO  
ABSOLUTE BLACK

OUTRAS PEDRAS  
OTRAS PIEDRAS  
OTHER STONES

XX= 01

11

21 / 31 / 41 / 51 / 61

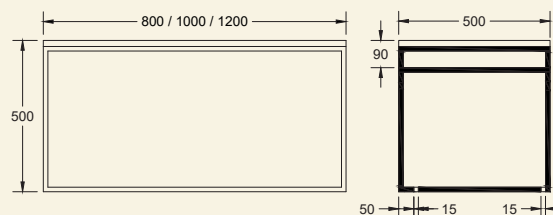

Size	REF	CRYSTAL WHITE	NEGRO ABSOLUTO ABSOLUTE BLACK	OUTRAS PEDRAS OTRAS PIEDRAS OTHER STONES
120 (120x50 cm)	5288xx23	1.149 €	1.190 €	1.285 €
100 (100x50 cm)	5288xx03	1.022 €	1.050 €	1.136 €
80 (80x50 cm)	5288xx83	894 €	910 €	985 €

**LIS**

REF

CRYSTAL WHITE

NEGRO ABSOLUTO  
ABSOLUTE BLACK

OUTRAS PEDRAS  
OTRAS PIEDRAS  
OTHER STONES

XX= 01

11

21 / 31 / 41 / 51 / 61

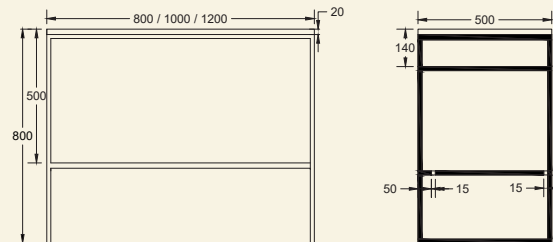

Size	REF	CRYSTAL WHITE	NEGRO ABSOLUTO ABSOLUTE BLACK	OUTRAS PEDRAS OTRAS PIEDRAS OTHER STONES
120 (120x50 cm)	5289xx23	1.185 €	1.224 €	1.318 €
100 (100x50 cm)	5289xx03	1.056 €	1.084 €	1.170 €
80 (80x50 cm)	5289xx83	929 €	945 €	1.019 €

**Opções de Pedra para os tampos:**  
Crystal White  
Granito Negro Absoluto  
Branco Carrara  
Indian Green  
Marron Imperador Dark  
Teak Wood Grey  
Travertino Italy

**Opciones de piedra para encimeras:**  
Crystal White  
Granito Negro Absoluto  
Blanco Carrara  
Indian Green  
Marron Imperador Dark  
Teak Wood Grey  
Travertino Italy

**Stone options for tops:**  
Crystal White  
Absolute Black Granite  
White Carrara  
Indian Green  
Marron Imperador Dark  
Teak Wood Grey  
Travertino Italy

BRANCO  
BLANCO  
WHITE

CORES STANDARD  
COLORES STANDARD  
STANDARD COLORS

CORES ESPECIAIS  
COLORES ESPECIALES  
SPECIAL COLORS

REF

PLACAS CERÂMICAS

XX= 00

23 / 47 / 48

PÁG. 8

Encimeras en cerámica  
Ceramic tops

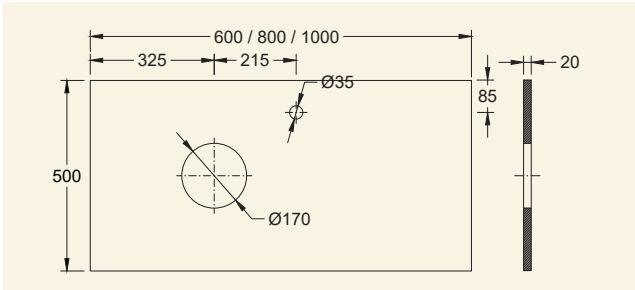

216 €	378 €	431 €	70240xx2C	100x50
190 €	333 €	380 €	70140xx2C	80x50
152 €	266 €	304 €	70040xx2C	60x50

As placas cerâmicas têm opções de furação sob consulta  
Las encimeras cerâmicas tienen opciones de perforación bajo pedido  
Ceramic tops have drilling options under request

INOX POLIDO  
ACERO INOXIDABLE PULIDO  
POLISHED STAINLESS STEEL

REF

SUPORTES FIXAÇÃO COM  
TOALHEIROS LATERAIS

204 €

55181001

Soportes de fijación inox pulido para lavabos  
Fixing supports in polished stainless steel for washbasin

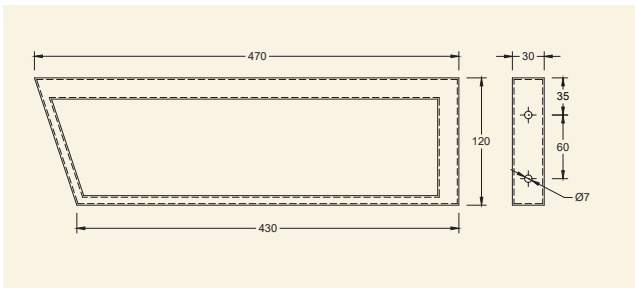



- 
- 
- 
- 
- 
- 
- 
- 
- 
- 
- 





# MÓVEIS

MUEBLES  
FURNITURE

<b>AVIZ</b>	112
<b>TABLE</b>	113
<b>BOX 43CM</b>	114
<b>BOX 50CM</b>	115



**AVIZ C/ GAVETÃO E GAVETA INTERIOR**

REF

BRANCO  
BLANCO  
WHITE

PRETO BRILHO  
NEGRO BRILHO  
BLACK SHINE

XX=

00

48

AVIZ c/ cajón y cajón interior  
AVIZ w/ external drawer and interior drawer

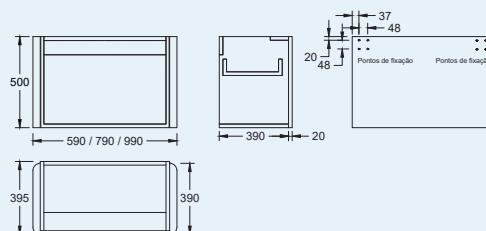

100 (100x50x40 cm)	52865xx4	940 €	1.032 €
80 (80x50x40 cm)	52865xx2	906 €	986 €
60 (60x50x40 cm)	52865xx1	878 €	952 €

**AVIZ C/ GAVETÃO**

AVIZ c/ cajón  
AVIZ w/ external drawer

100 (100x50x40 cm)	52805xx4	769 €	860 €
80 (80x50x40 cm)	52805xx2	743 €	823 €
60 (60x50x40 cm)	52805xx1	722 €	795 €

**AVIZ C/ 2 PORTAS**

AVIZ c/ 2 portas  
AVIZ w/ 2 doors

100 (100x50x40 cm)	52806xx4	695 €	786 €
80 (80x50x40 cm)	52806xx2	671 €	750 €
60 (60x50x40 cm)	52806xx1	648 €	722 €

	BRANCO BLANCO WHITE	PRETO BRILHO NEGRO BRILHO BLACK SHINE	NOGUEIRA NOGAL WALNUT	REF	BANCADA
XX=	00	48	76		Bancada Washbasin Top

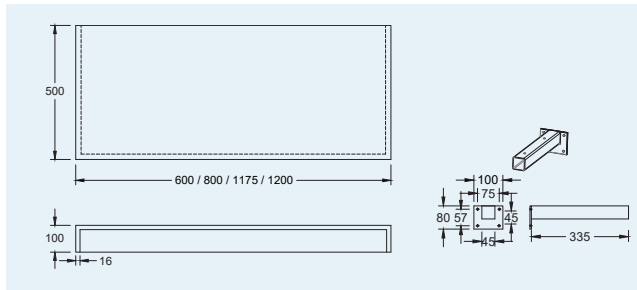

403 €	477 €	477 €	52815xx4	(120x50x10 cm) 120
366 €	421 €	421 €	52815xx3	(100x50x10 cm) 100
308 €	383 €	383 €	52815xx2	(80x50x10 cm) 80
295 €	334 €	334 €	52815xx1	(60x50x10 cm) 60

**MÓDULO C/ GAVETA**

Módulo con cajón  
Module w/ drawer

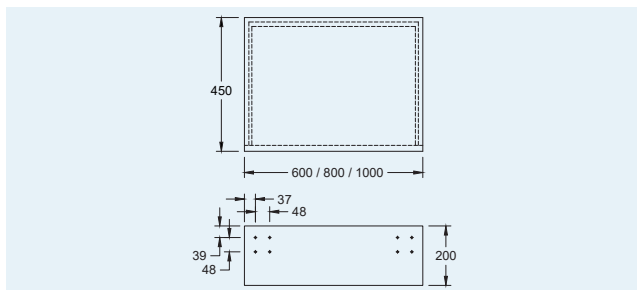

418 €	518 €	518 €	52817xx3	(100x50x30 cm) 100
382 €	475 €	475 €	52817xx2	(80x50x30 cm) 80
360 €	440 €	440 €	52817xx1	(60x50x30 cm) 60



**BOX SEM TAMPO, COM GAVETÃO E GAVETA INTERIOR**

REF

BRANCO  
BLANCO  
WHITE

PRETO BRILHO  
NEGRO BRILHO  
BLACK SHINE

NOGUEIRA  
NOGAL  
WALNUT

Box sin encimera, con gavetón y cajón interior  
Box without top, w/ external drawer and interior drawer

XX= 00 48 76

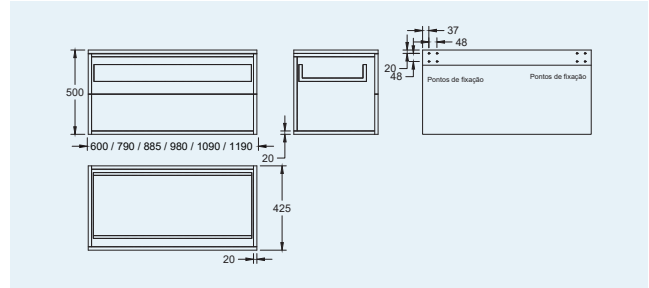

120x43 (120x43x50 cm)	52846xx6C/D/E	782 €	822 €	822 €
110x43 (110x43x50 cm)	52846xx5C/D/E	765 €	807 €	807 €
100x43 (100x43x50 cm)	52846xx4C/D/E	643 €	682 €	682 €
90x43 (90x43x50 cm)	52846xx3C/D/E	626 €	665 €	665 €
80x43 (80x43x50 cm)	52846xx2C/D/E	608 €	643 €	643 €
60x43 (60x43x50 cm)	52846xx1	580 €	616 €	616 €

**BOX SEM TAMPO E COM GAVETÃO**

Box sin encimera y con cajón  
Box without top, w/ external drawer

120x43 (120x43x50 cm)	52826xx6	532 €	571 €	571 €
110x43 (110x43x50 cm)	52826xx5	520 €	562 €	562 €
100x43 (100x43x50 cm)	52826xx4	471 €	510 €	510 €
90x43 (90x43x50 cm)	52826xx3	458 €	496 €	496 €
80x43 (80x43x50 cm)	52826xx2	444 €	480 €	480 €
60x43 (60x43x50 cm)	52826xx1	423 €	458 €	458 €

**BOX SEM TAMPO COM 2 GAVETAS**

Box sin encimera y con 2 cajones  
Box without top, w/ 2 external drawers

120x43 (120x43x50 cm)	52842xx6C/D/E	782 €	822 €	822 €
110x43 (110x43x50 cm)	52842xx5C/D/E	765 €	807 €	807 €
100x43 (100x43x50 cm)	52842xx4C/D/E	643 €	682 €	682 €
90x43 (90x43x50 cm)	52842xx3C/D/E	626 €	665 €	665 €
80x43 (80x43x50 cm)	52842xx2C/D/E	608 €	643 €	643 €
60x43 (60x43x50 cm)	52842xx1	580 €	616 €	616 €

C - p/ lavatórios pio central | p/ lavabos cuba al centro | for washbasins centered sink  
D - p/ lavatórios pio direito | p/ lavabos cuba derecha | for washbasins w/ right sink  
E - p/ lavatórios pio esquerdo | p/ lavabos cuba izquierda | for washbasins w/ left sink



BRANCO  
BLANCO  
WHITEPRETO BRILHO  
NEGRO BRILHO  
BLACK SHINENOGUEIRA  
NOGAL  
WALNUT

REF

**BOX COM TAMPO, COM  
GAVETÃO E GAVETA INTERIOR**

Box con encimera, con cajón y  
cajón interior  
Box with top, w/ external drawer  
and interior drawer

XX=

00

48

76

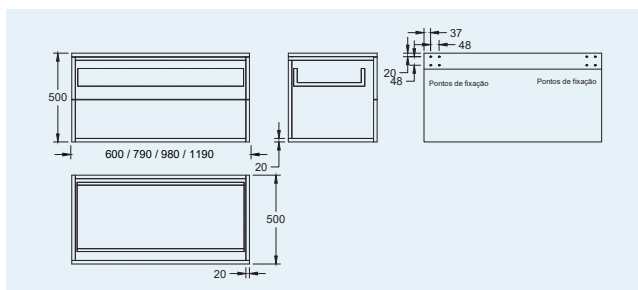

900 €	973 €	973 €	52855xx6	(120x50x50 cm) 120x50
750 €	822 €	822 €	52855xx4	(100x50x50cm) 100x50
697 €	766 €	766 €	52855xx2	(80x50x50 cm) 80x50
657 €	726 €	726 €	52855xx1	(60x50x50 cm) 60x50

**BOX SEM TAMPO, COM GAVETÃO  
E GAVETA INTERIOR**

Box sin encimera, con cajón y cajón  
interior  
Box without top, w/ external drawer  
and interior drawer

782 €	822 €	822 €	52845xx6	(120x50x50 cm) 120x50
643 €	687 €	687 €	52845xx4	(100x50x50cm) 100x50
609 €	643 €	643 €	52845xx2	(80x50x50 cm) 80x50
582 €	620 €	620 €	52845xx1	(60x50x50 cm) 60x50

**BOX COM TAMPO E COM  
GAVETÃO**

Box con encimera y con cajón  
Box with top, w/ external drawer

651 €	725 €	725 €	52835xx6	(120x50x50 cm) 120x50
579 €	649 €	649 €	52835xx4	(100x50x50cm) 100x50
535 €	605 €	605 €	52835xx2	(80x50x50 cm) 80x50
497 €	567 €	567 €	52835xx1	(60x50x50 cm) 60x50

**BOX SEM TAMPO E COM  
GAVETÃO**

Box sin encimera y con cajón  
Box without top, w/ external drawer

532 €	571 €	571 €	52825xx6	(120x50x50 cm) 120x50
471 €	510 €	510 €	52825xx4	(100x50x50cm) 100x50
444 €	480 €	480 €	52825xx2	(80x50x50 cm) 80x50
423 €	458 €	458 €	52825xx1	(60x50x50 cm) 60x50



**BOX COM TAMPO E COM  
2 GAVETAS**

REF

BRANCO  
BLANCO  
WHITEPRETO BRILHO  
NEGRO BRILHO  
BLACK SHINENOGUEIRA  
NOGAL  
WALNUTBox con encimera y con 2 cajones  
Box with top, w/ 2 external drawers

xx=

00

48

76

120x50 (120x50x50 cm)	52847xx6	900 €	973 €	973 €
100x50 (100x50x50 cm)	52847xx4	750 €	822 €	822 €
80x50 (80x50x50 cm)	52847xx2	697 €	766 €	766 €
60x50 (60x50x50 cm)	52847xx1	657 €	726 €	726 €

**BOX SEM TAMPO E COM  
2 GAVETAS**Box sin encimera y con 2 cajones  
Box, without top, w/ 2 external  
drawers

120x50 (120x50x50 cm)	52843xx6	782 €	822 €	822 €
100x50 (100x50x50 cm)	52843xx4	643 €	687 €	687 €
80x50 (80x50x50 cm)	52843xx2	609 €	647 €	647 €
60x50 (60x50x50 cm)	52843xx1	582 €	620 €	620 €







## TORNEIRAS

GRIFERIA  
TAPS

<b>LUNA</b>	128
<b>LOTTO</b>	135
<b>FIDJI</b>	142
<b>LINE</b>	148
<b>CLASSIC</b>	153
<b>CAYENNE</b>	158
<b>SENSOR</b>	164
<b>TEMPORIZADAS</b> TEMPORIZADOS TIMER TAPS	166
<b>MISTURADORAS DE DUCHE COM COLUNA</b> MEZCLADORES DE DUCHA DE COLUMNA COLUMN SHOWER MIXERS	171
<b>ACESSÓRIOS DE DUCHE</b> ACCESORIOS DE DUCHA SHOWER ACCESSORIES	174

LUNA



PAG 128



PAG 129

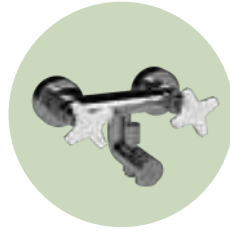

PAG 129

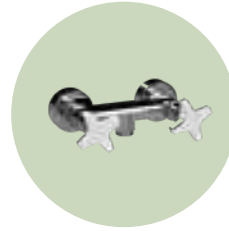

PAG 130

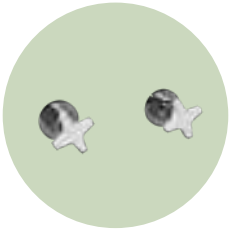

PAG 130

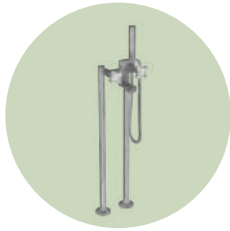

PAG 129



PAG 132



PAG 128

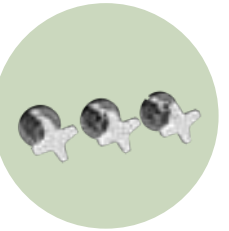

PAG 130



PAG 128



PAG 132

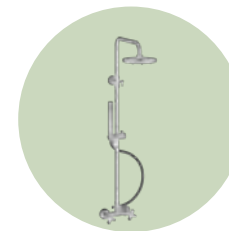

PAG 131



PAG 133



PAG 133



PAG 131

LOTTO



PAG 135

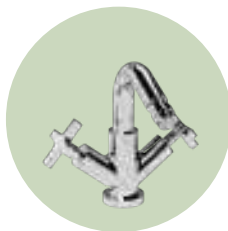

PAG 136



PAG 136

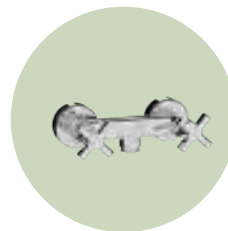

PAG 137



PAG 137



PAG 140



PAG 135



PAG 136



PAG 137



PAG 135



PAG 138



PAG 141



PAG 141



PAG 140



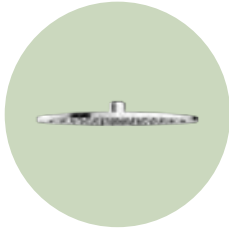

PAG 147



PAG 142



PAG 143

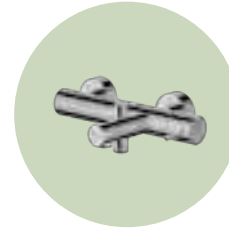

PAG 143

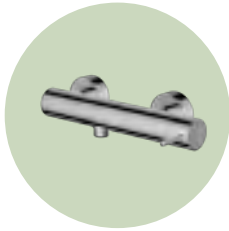

PAG 144



PAG 142



PAG 144



PAG 143

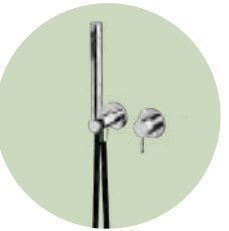

PAG 146



PAG 146

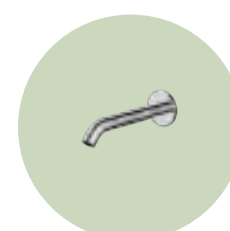

PAG 145

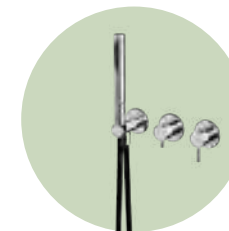

PAG 145

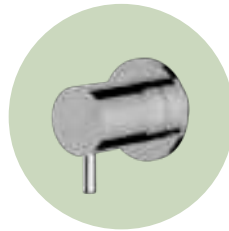

PAG 144



PAG 146



PAG 142

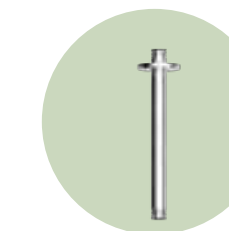

PAG 147

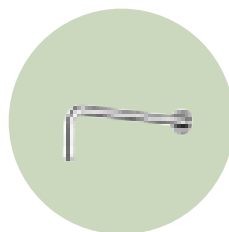

PAG 147



PAG 147



LINE



PAG 148



PAG 148

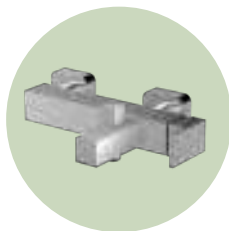

PAG 149

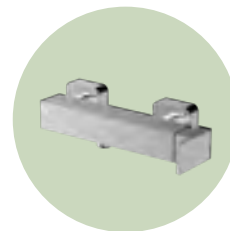

PAG 149



PAG 149



PAG 150

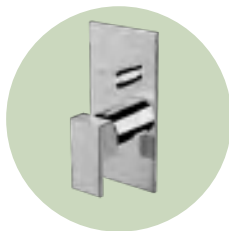

PAG 150

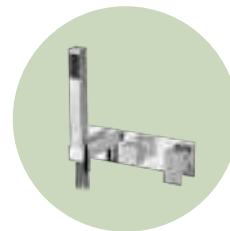

PAG 150

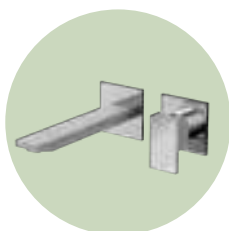

PAG 148



PAG 151

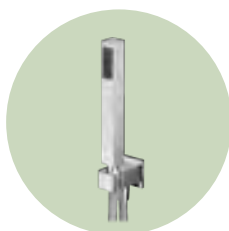

PAG 152



PAG 151



PAG 151



CLASSIC



PAG 153



PAG 153

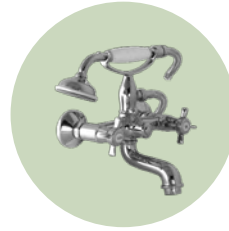

PAG 154

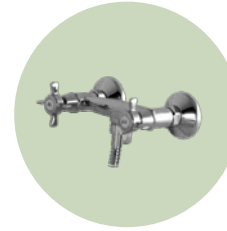

PAG 154

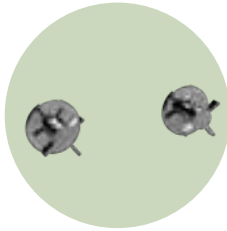

PAG 155



PAG 154



PAG 154



PAG 153



PAG 155

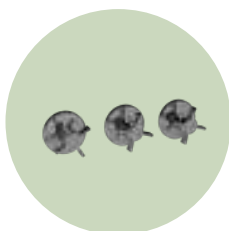

PAG 155



PAG 153



PAG 154



PAG 156



PAG 156



PAG 156



## CAYENNE



PAG 158



PAG 159

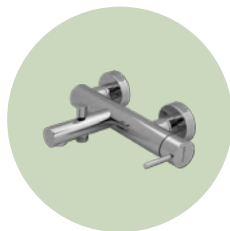

PAG 159

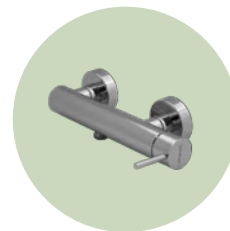

PAG 160

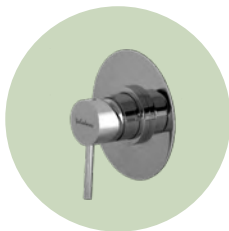

PAG 160



PAG 158



PAG 160

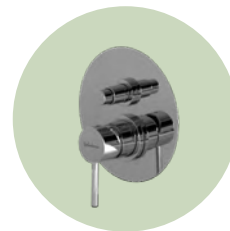

PAG 160



PAG 159



PAG 158



PAG 163

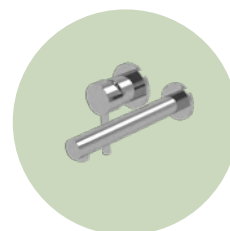

PAG 159

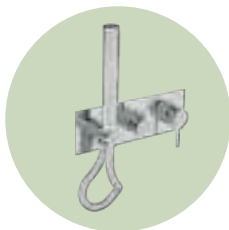

PAG 161

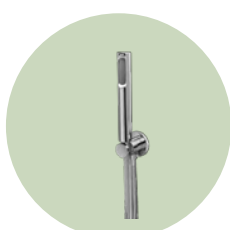

PAG 162

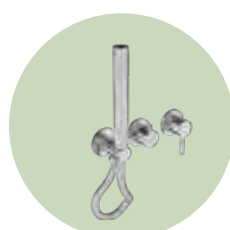

PAG 162



SENSOR



PAG 164



PAG 164

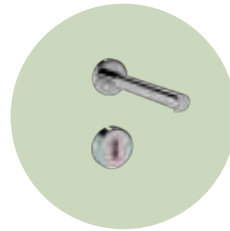

PAG 164

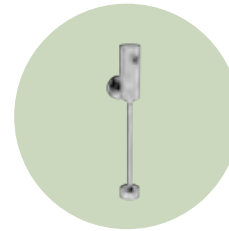

PAG 164

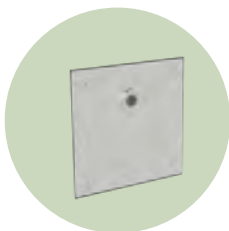

PAG 165

TEMPORIZADAS | TEMPORIZADOS | TIMER TAPS



PAG 168



PAG 166



PAG 167



PAG 169



PAG 168



PAG 168



PAG 170



PAG 169



PAG 168



PAG 166



PAG 167



PAG 167

TEMPORIZADAS | TEMPORIZADOS | TIMER TAPS



PAG 167



PAG 166



PAG 166



PAG 169



PAG 169

MISTURADORAS DE DUCHE COM COLUNA | MEZCLADORES DE DUCHA DE COLUMNA  
COLUMN SHOWER MIXERS



PAG 171 A 173



**MISTURADORA DE LAVATÓRIO C/ VCC**

REF

BRANCO - CROMADO  
BLANCO - CROMO  
WHITE - CHROME

CROMADO - CORES STANDARD  
CROMO - COLORES STANDARD  
CHROME - STANDARD COLORS

CORES ESPECIAIS  
COLORES **ESPECIALES**  
SPECIAL COLORS

Mezcladora de lavabo con VCC  
Washbasin mixer with VCC

XX= 00

23 / 47 / 48

VER PÁG. 8

50621022xx

240 €

266 €

291 €

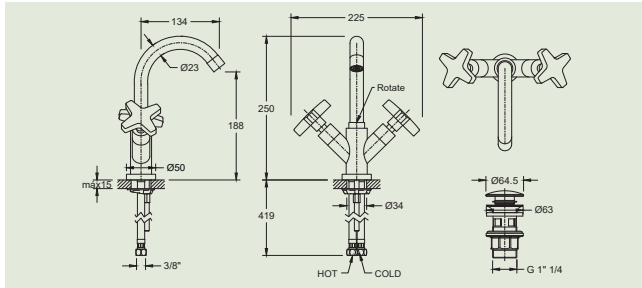

**MISTURADORA MURAL DE LAVATÓRIO C/ VCC**

REF

BRANCO - CROMADO  
BLANCO - CROMO  
WHITE - CHROME

CROMADO - CORES STANDARD  
CROMO - COLORES STANDARD  
CHROME - STANDARD COLORS

CORES ESPECIAIS  
COLORES **ESPECIALES**  
SPECIAL COLORS

Mezcladora de lavabo de pared con VCC  
Wall mounted washbasin mixer with VCC

XX= 00

23 / 47 / 48

VER PÁG. 8

50621222xx

239 €

264 €

290 €

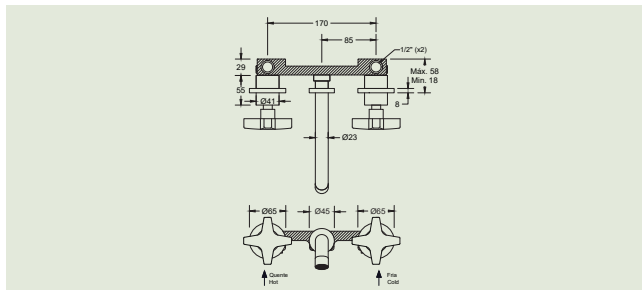

**MISTURADORA DE LAVATÓRIO 3 FUROS C/ VCC**

REF

BRANCO - CROMADO  
BLANCO - CROMO  
WHITE - CHROME

CROMADO - CORES STANDARD  
CROMO - COLORES STANDARD  
CHROME - STANDARD COLORS

CORES ESPECIAIS  
COLORES **ESPECIALES**  
SPECIAL COLORS

Mezcladora de lavabo 3 agujeros con VCC  
3 holes washbasin mixer with VCC

XX= 00

23 / 47 / 48

VER PÁG. 8

50621322xx

496 €

574 €

653 €

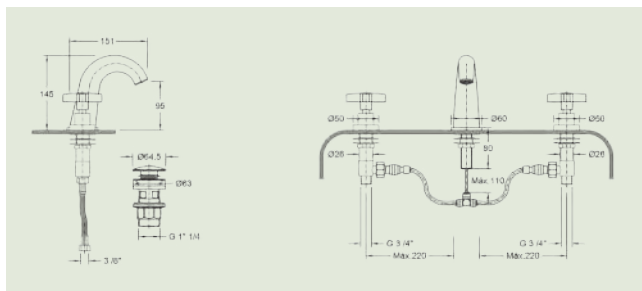

BRANCO - CROMADO  
BLANCO - CROMO  
WHITE - CHROME

CROMADO - CORES STANDARD  
CROMO - COLORES STANDARD  
CHROME - STANDARD COLORS

CORES ESPECIAIS  
COLORES **ESPECIALES**  
SPECIAL COLORS

REF

**MISTURADORA DE BIDÉ C/ VCC**

XX= 00 23 / 47 / 48 VER PÁG. 8

Mezcladora de bidé con VCC  
Bidet mixer with VCC

241 € 267 € 293 €

50621042xx

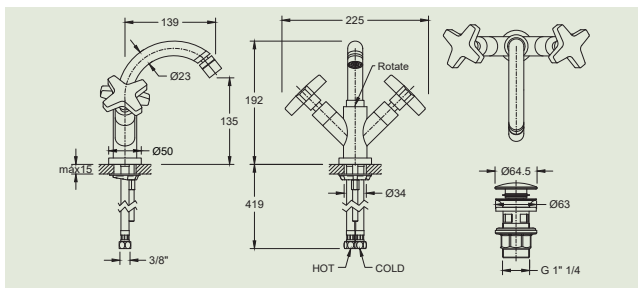

BRANCO - CROMADO  
BLANCO - CROMO  
WHITE - CHROME

CROMADO - CORES STANDARD  
CROMO - COLORES STANDARD  
CHROME - STANDARD COLORS

CORES ESPECIAIS  
COLORES **ESPECIALES**  
SPECIAL COLORS

REF

**MISTURADORA DE BANHEIRA C/ KIT DE CHUVEIRO**

XX= 00 23 / 47 / 48 VER PÁG. 8

Mezcladora de bañera con  
kit de ducha  
Bath mixer with shower kit

268 € 294 € 320 €

50621052xx

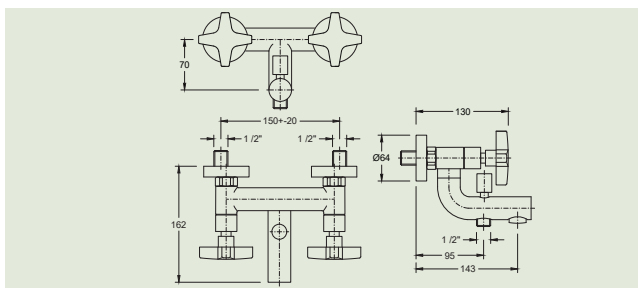

BRANCO - CROMADO  
BLANCO - CROMO  
WHITE - CHROME

CROMADO - CORES STANDARD  
CROMO - COLORES STANDARD  
CHROME - STANDARD COLORS

CORES ESPECIAIS  
COLORES **ESPECIALES**  
SPECIAL COLORS

REF

**MISTURADORA DE CHÃO DE BANHEIRA C/ KIT DE CHUVEIRO MANUAL**

XX= 00 23 / 47 / 48 VER PÁG. 8

Mezcladora de suelo de baño c/ kit de ducha manual  
Floor bath mixer with shower kit

782 € 808 € 834 €

50621152xx

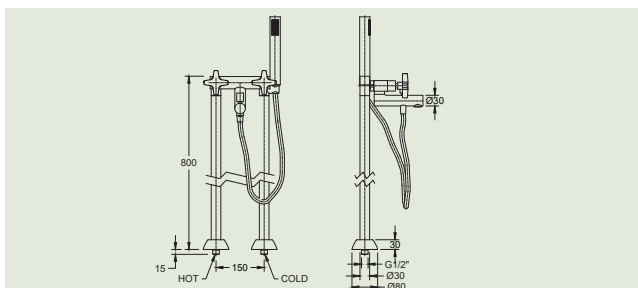

**MISTURADORA DE DUCHE C/ KIT DE CHUVEIRO**

REF

BRANCO - CROMADO  
BLANCO - CROMO  
WHITE - CHROME

CROMADO - CORES STANDARD  
CROMO - COLORES STANDARD  
CHROME - STANDARD COLORS

CORES ESPECIAIS  
COLORES **ESPECIALES**  
SPECIAL COLORS

Mezcladora de ducha con kit de ducha  
Shower mixer with shower kit

50621062xx

XX= 00 23 / 47 / 48 VER PÁG. 8

214 € 241 € 267 €

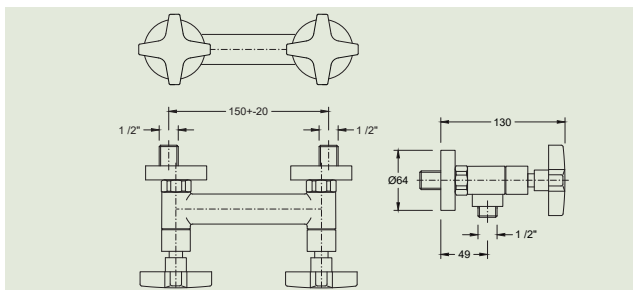

**MISTURADORA DE DUCHE 1 SAÍDA**

REF

BRANCO - CROMADO  
BLANCO - CROMO  
WHITE - CHROME

CROMADO - CORES STANDARD  
CROMO - COLORES STANDARD  
CHROME - STANDARD COLORS

CORES ESPECIAIS  
COLORES **ESPECIALES**  
SPECIAL COLORS

Mezcladora de ducha 1 salida  
Shower mixer with 1 way out

50621072xx

XX= 00 23 / 47 / 48 VER PÁG. 8

191 € 217 € 243 €

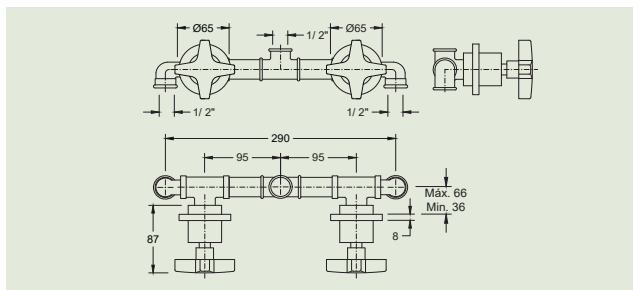

**MISTURADORA DE DUCHE C/ INVERSOR ROTATIVO 2 SAÍDAS**

REF

BRANCO - CROMADO  
BLANCO - CROMO  
WHITE - CHROME

CROMADO - CORES STANDARD  
CROMO - COLORES STANDARD  
CHROME - STANDARD COLORS

CORES ESPECIAIS  
COLORES **ESPECIALES**  
SPECIAL COLORS

Mezcladora de ducha con inversor 2 salidas  
Shower mixer with 2 ways diverter

50621272xx

XX= 00 23 / 47 / 48 VER PÁG. 8

278 € 304 € 331 €

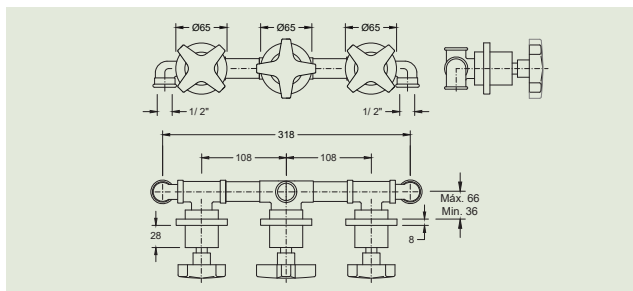



BRANCO - CROMADO  
BLANCO - CROMO  
WHITE - CHROME

CROMADO - CORES STANDARD  
CROMO - COLORES STANDARD  
CHROME - STANDARD COLORS

CORES ESPECIAIS  
COLORES **ESPECIALES**  
SPECIAL COLORS

REF

**MISTURADORA DE DUCHE C/  
INVERSOR ROTATIVO 3 SAÍDAS**

XX= 00 23 / 47 / 48 VER PÁG. 8

319 € 359 € 397 €

50621372xx

Mezcladora de ducha con  
inversor 3 salidas  
Shower mixer with 3 ways diverter

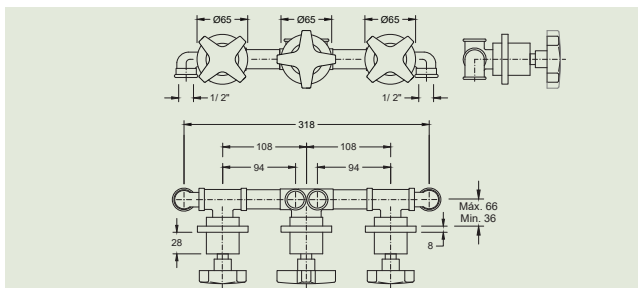

BRANCO - CROMADO  
BLANCO - CROMO  
WHITE - CHROME

CROMADO - CORES STANDARD  
CROMO - COLORES STANDARD  
CHROME - STANDARD COLORS

CORES ESPECIAIS  
COLORES **ESPECIALES**  
SPECIAL COLORS

REF

**MISTURADORA DE DUCHE C/ COLUNA  
EXTENSÍVEL E CHUVEIRO  
CAIRO 200MM**

XX= 00 23 / 47 / 48 VER PÁG. 8

528 € 555 € 581 €

50621472xx

Mezclador de ducha con columna  
extensible y ducha Cairo 200mm  
Shower mixer with extendable column  
and Cairo 200mm shower

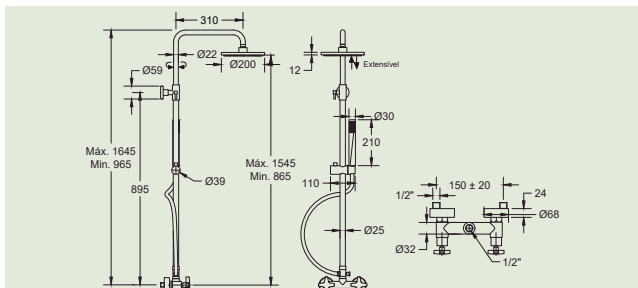

BRANCO - CROMADO  
BLANCO - CROMO  
WHITE - CHROME

CROMADO - CORES STANDARD  
CROMO - COLORES STANDARD  
CHROME - STANDARD COLORS

CORES ESPECIAIS  
COLORES **ESPECIALES**  
SPECIAL COLORS

REF

**VCC C/ TAMP A CERÂMICA**

XX= 00 23 / 47 / 48 VER PÁG. 8

56 € 74 € 92 €

55110022xx

VCC con tapa cerâmica  
VCC with ceramic cover

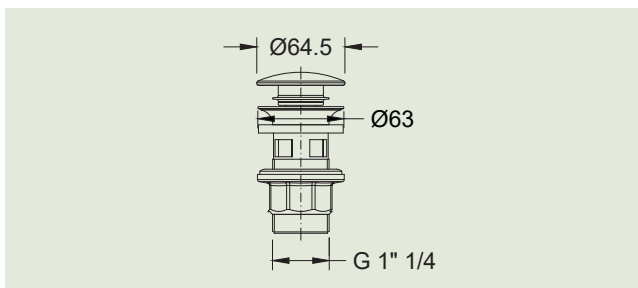

**TORNEIRA DE ESQUADRIA 1/2"x3/8"**

REF

BRANCO - CROMADO  
BLANCO - CROMO  
WHITE - CHROME

CROMADO - CORES STANDARD  
CROMO - COLORES STANDARD  
CHROME - STANDARD COLORS

CORES ESPECIAIS  
COLORES **ESPECIALES**  
SPECIAL COLORS

Grifo de escuadra 1/2 "x3/8"  
Cutting tap 1/2 "x3/8"

xx= 00

23 / 47 / 48

VER PÁG. 8

50621192xx

51 €

63 €

76 €

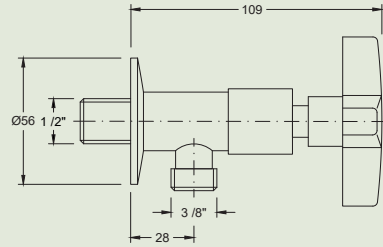

**TORNEIRA DE ESQUADRIA 1/2"x1/2"**

REF

BRANCO - CROMADO  
BLANCO - CROMO  
WHITE - CHROME

CROMADO - CORES STANDARD  
CROMO - COLORES STANDARD  
CHROME - STANDARD COLORS

CORES ESPECIAIS  
COLORES **ESPECIALES**  
SPECIAL COLORS

Grifo de escuadra 1/2"x1/2"  
Cutting tap 1/2"x1/2"

xx= 00

23 / 47 / 48

VER PÁG. 8

50621292xx

51 €

63 €

76 €

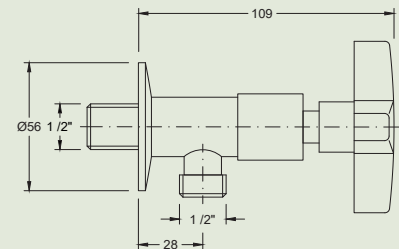

**TORNEIRA DE PASSAGEM DE ENCASTRAR 1/2"**

REF

BRANCO - CROMADO  
BLANCO - CROMO  
WHITE - CHROME

CROMADO - CORES STANDARD  
CROMO - COLORES STANDARD  
CHROME - STANDARD COLORS

CORES ESPECIAIS  
COLORES **ESPECIALES**  
SPECIAL COLORS

Grifo de corte empotrado de 1/2 "  
Wall-mounted cutting tap 1/2 "

xx= 00

23 / 47 / 48

VER PÁG. 8

50621392xx

52 €

65 €

78 €

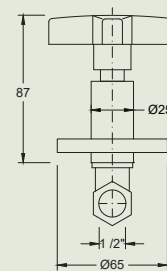

BRANCO - CROMADO  
BLANCO - CROMO  
WHITE - CHROMECROMADO - CORES STANDARD  
CROMO - COLORES STANDARD  
CHROME - STANDARD COLORSCORES ESPECIAIS  
COLORES ESPECIALES  
SPECIAL COLORS

REF

**TORNEIRA DE PASSAGEM DE  
ENCASTRAR 3/4"**

XX= 00

23 / 47 / 48

VER PÁG. 8

58 €

72 €

84 €

50621492xx

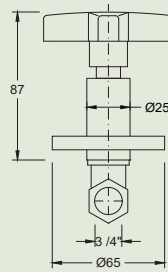
Grifo de corte empotrado 3/4"  
Wall-mounted cutting tap 3/4"BRANCO - CROMADO  
BLANCO - CROMO  
WHITE - CHROMECROMADO - CORES STANDARD  
CROMO - COLORES STANDARD  
CHROME - STANDARD COLORSCORES ESPECIAIS  
COLORES ESPECIALES  
SPECIAL COLORS

REF

**MISTURADORA DE COZINHA  
C/ BICA ROTATIVA**

XX= 00

23 / 47 / 48

VER PÁG. 8

289 €

316 €

341 €

50621482xx

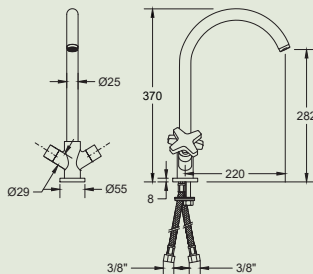
Mezcladora de cocina con cãno giratorio  
Kitchen mixer with rotating spoutBRANCO - CROMADO  
BLANCO - CROMO  
WHITE - CHROMEPRETO - NÍQUEL ESCOVADO  
NEGRO - NÍQUEL PULIDO  
BLACK - BRUSHED NICKEL

REF

**TOMADA DE ÁGUA C/ SUPORTE  
CHUVEIRO DE MÃO**

XX= 2

3 / 0

53 €

80 €

5517302x

Conexión de agua con soporte de ducha  
de mano  
Water outlet w/ hand shower supportBRANCO - CROMADO  
BLANCO - CROMO  
WHITE - CHROMEPRETO - NÍQUEL ESCOVADO  
NEGRO - NÍQUEL PULIDO  
BLACK - BRUSHED NICKEL

REF

**HASTE DE PAREDE 35CM**

XX= 2

3 / 0

42 €

63 €

5069723x

Barra mural para ducha con 35cm  
Wall rod 35cmBRANCO - CROMADO  
BLANCO - CROMO  
WHITE - CHROMEPRETO - NÍQUEL ESCOVADO  
NEGRO - NÍQUEL PULIDO  
BLACK - BRUSHED NICKEL

REF

**HASTE DE TECTO DE 15CM**

XX= 2

3 / 0

30 €

46 €

5069724x

Barra de tecto 15cm  
Ceilling rod 15cmBRANCO - CROMADO  
BLANCO - CROMO  
WHITE - CHROMEPRETO - NÍQUEL ESCOVADO  
NEGRO - NÍQUEL PULIDO  
BLACK - BRUSHED NICKEL

REF

**CHUVEIRO DE MÃO (8 L/MIN.)**

XX= 2

3 / 0

22 €

55 €

5069706x

Ducha de mano (8 L/min.)  
Hand shower (8 L/min.)

**CHUVEIRO DE TECTO 20CM  
REDONDO EM LATÃO (8 L/MIN.)**

REF

BRANCO - CROMADO  
BLANCO - CROMO  
WHITE - CHROMEPRETO - NÍQUEL ESCOVADO  
NEGRO - NÍQUEL PULIDO  
BLACK - BRUSHED NICKELDucha de techo en laton 20cm redondo  
(8 L/min.)  
Brass head shower 20cm (8 L/min.)

5068311x

xx=

2

3 / 0

119 €

159 €

**FLEXÍVEL DUPLA GRAFATURA 150CM**

REF

BRANCO - CROMADO  
BLANCO - CROMO  
WHITE - CHROMEPRETO - NÍQUEL ESCOVADO  
NEGRO - NÍQUEL PULIDO  
BLACK - BRUSHED NICKELManguera de ducha de mano 150cm  
Shower flexible hose 150cm

5061702x

xx=

2

3 / 0

14 €

22 €

**FLEXÍVEL PVC ANTI-TORSÃO 150CM**

REF

BRANCO - CROMADO  
BLANCO - CROMO  
WHITE - CHROMEPRETO - NÍQUEL ESCOVADO  
NEGRO - NÍQUEL PULIDO  
BLACK - BRUSHED NICKELManguera de ducha PVC anti-torsión  
150cm  
PVC anti-torsion shower flexible hose  
150cm

5061704x

xx=

2

3 / 0

18 €

26 €

CROMADO  
CROMO  
CHROME

PRETO MATE  
NEGRO MATE  
MATT BLACK

REF

MISTURADORA DE LAVATÓRIO C/ VCC

X = 2

X = 3

Mezcladora de lavabo c / VCC  
Washbasin mixer with VCC

184 €

276 €

5066202x

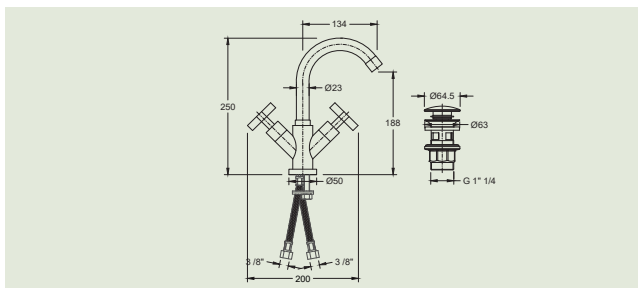

CROMADO  
CROMO  
CHROME

PRETO MATE  
NEGRO MATE  
MATT BLACK

REF

MISTURADORA DE LAVATÓRIO MURAL C/ VCC

X = 2

X = 3

Mezcladora de lavabo mural c / VCC  
Wall mounted washbasin mixer with VCC

251 €

377 €

5066222x

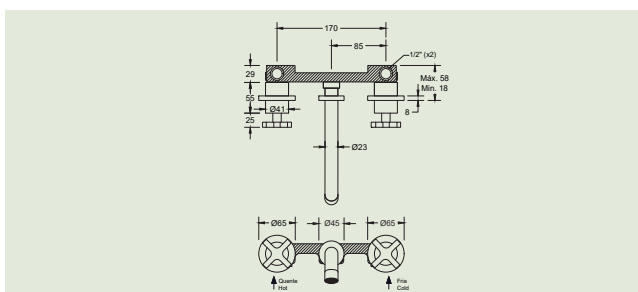

CROMADO  
CROMO  
CHROME

PRETO MATE  
NEGRO MATE  
MATT BLACK

REF

MISTURADORA DE LAVATÓRIO 3 FUROS C/ VCC

X = 2

X = 3

Mezcladora de lavabo 3 agujeros c / VCC  
3 holes washbasin mixer with VCC

240 €

359 €

5066232x

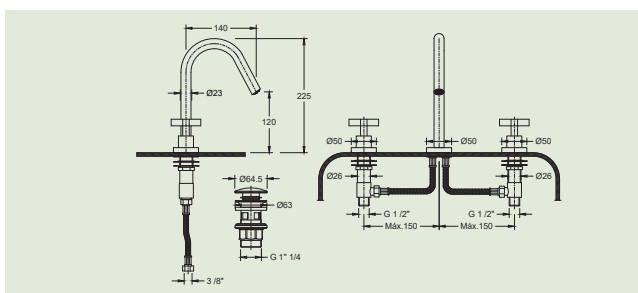

**MISTURADORA BIDÉ C/ VCC**

REF

CROMADO  
CROMO  
CHROME

PRETO MATE  
NEGRO MATE  
MATT BLACK

Mezcladora de bidé c/ VCC  
Bidet mixer with VCC

X = 2

X = 3

5066204x

184 €

276 €

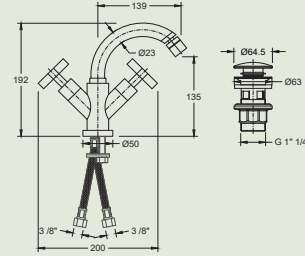

**MISTURADORA DE BANHEIRA C/ KIT DE CHUVEIRO MANUAL**

REF

CROMADO  
CROMO  
CHROME

PRETO MATE  
NEGRO MATE  
MATT BLACK

Mezcladora de bañera c/ kit de ducha manual  
Bath mixer with shower kit

X = 2

X = 3

5066205x

275 €

413 €

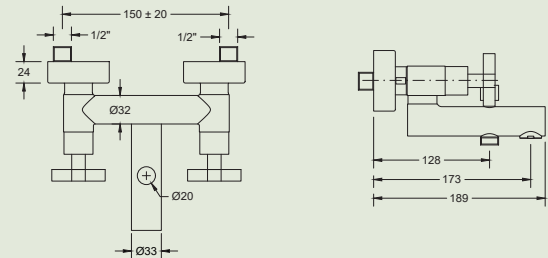

**MISTURADORA DE CHÃO DE BANHEIRA C/ KIT DE CHUVEIRO MANUAL**

REF

CROMADO  
CROMO  
CHROME

PRETO MATE  
NEGRO MATE  
MATT BLACK

Mezcladora de suelo de baño c/ kit de ducha manual  
Floor bath mixer with shower kit

X = 2

X = 3

5066225x

730 €

1.095 €

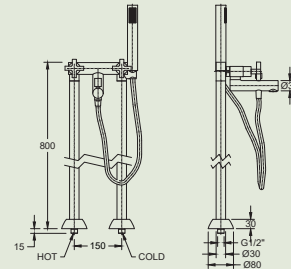

CROMADO  
CROMO  
CHROME

PRETO MATE  
NEGRO MATE  
MATT BLACK

REF

**MISTURADORA DE DUCHE C/ KIT DE CHUVEIRO MANUAL**

X = 2

X = 3

204 €

305 €

5066206x

Mezcladora de ducha con kit de ducha manual  
Shower mixer with shower kit

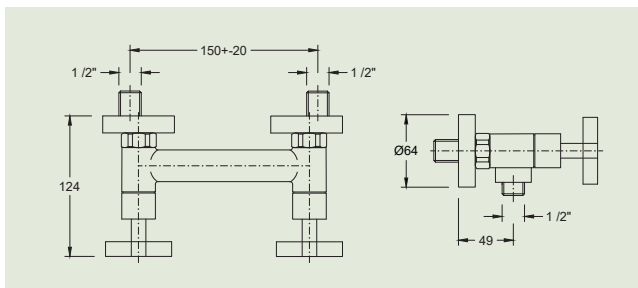

CROMADO  
CROMO  
CHROME

PRETO MATE  
NEGRO MATE  
MATT BLACK

REF

**MONOCOMANDO DUCHE MURAL**

X = 2

X = 3

175 €

262 €

5066207x

Monocomando ducha mural  
Wall mounted single lever shower mixer

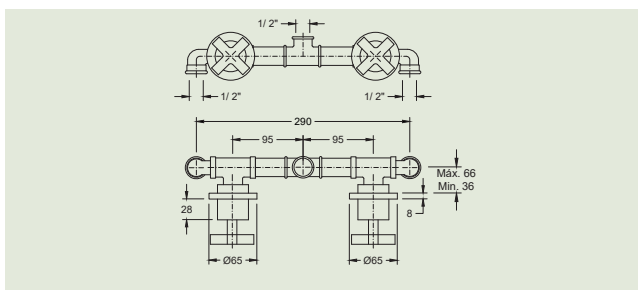

CROMADO  
CROMO  
CHROME

PRETO MATE  
NEGRO MATE  
MATT BLACK

REF

**MISTURADORA DUCHE MURAL 2 VIAS C/ KIT CHUVEIRO MANUAL**

X = 2

X = 3

288 €

432 €

5066227x

Mezcladora ducha mural 2 vías c / kit de ducha manual  
Wall mounted shower mixer with 2 ways diverter, shower kit

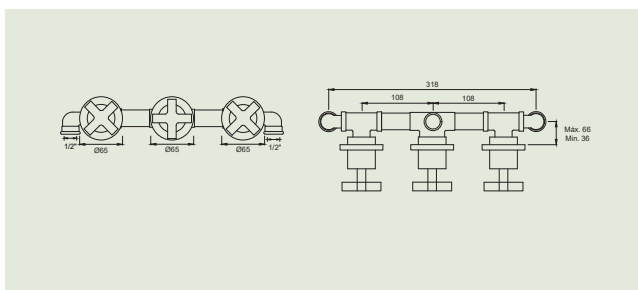

**MISTURADORA DUCHE MURAL 3 VIAS C/ KIT CHUVEIRO MANUAL**

REF

CROMADO  
CROMO  
CHROME

PRETO MATE  
NEGRO MATE  
MATT BLACK

Mezcladora ducha mural 3 vías c / kit de ducha manual  
Wall mounted shower mixer with 3 ways diverter, shower kit

5066257x

X = 2

X = 3

328 €

492 €

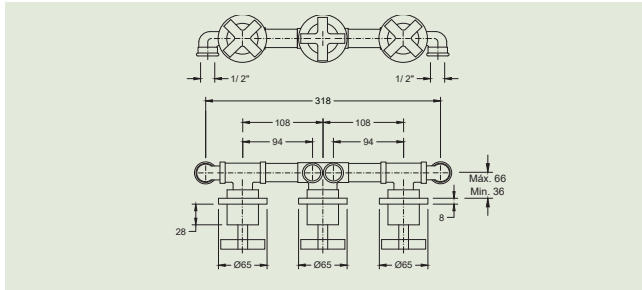

**MISTURADORA DUCHE C/COLUNA TELESCÓPICA E CHUV. CAIRO 200MM**

REF

CROMADO  
CROMO  
CHROME

PRETO MATE  
NEGRO MATE  
MATT BLACK

Mezcladora de ducha con columna telescópica y ducha Cairo 200mm  
Shower mixer with telescopic column and head shower Cairo 200mm

5066247x

X = 2

X = 3

440 €

659 €

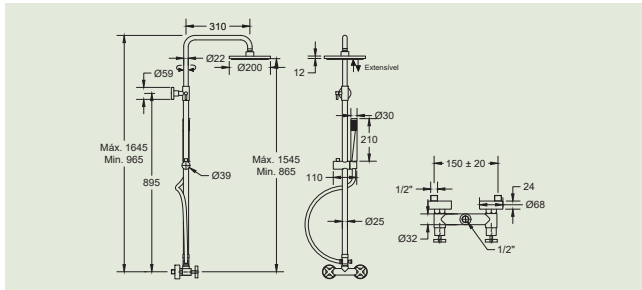

**TOMADA DE ÁGUA C/ SUPORTE**

REF

CROMADO  
CROMO  
CHROME

PRETO MATE  
NEGRO MATE  
MATT BLACK

Conexión de agua con soporte  
Wall mounted water outlet with hand shower support

5517302x

X = 2





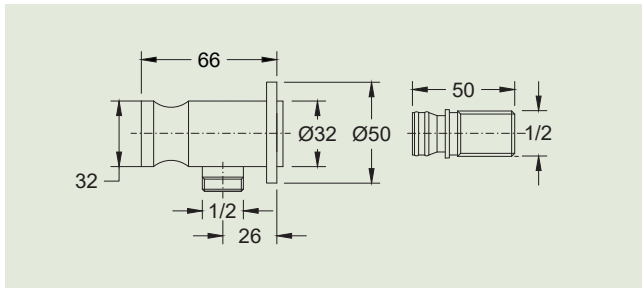

X = 3

53 €

80 €





CROMADO CROMO CHROME	PRETO MATE NEGRO MATE MATT BLACK	REF	<b>HASTE DE PAREDE 35CM</b>	
X = 2	X = 3		Barra mural para ducha con 35cm Wall rod 35cm	
42 €	63 €	5069723x		
CROMADO CROMO CHROME	PRETO MATE NEGRO MATE MATT BLACK	REF	<b>HASTE DE TECTO DE 15CM</b>	
X = 2	X = 3		Barra de techo 15cm Ceilling rod 15cm	
30 €	46 €	5069724x		
CROMADO CROMO CHROME	PRETO MATE NEGRO MATE MATT BLACK	REF	<b>CHUVEIRO DE MÃO (8 L/MIN.)</b>	
X = 2	X = 3		Ducha de mano (8 L/min.) Hand shower (8 L/min.)	
22 €	55 €	5069706x		
CROMADO CROMO CHROME	PRETO MATE NEGRO MATE MATT BLACK	REF	<b>CHUVEIRO DE TECTO 20CM REDONDO EM LATÃO (8 L/MIN.)</b>	
X = 2	X = 3		Ducha de techo en laton 20cm redondo (8 L/min.) Brass head shower 20cm (8 L/min.)	
119 €	159 €	5068311x		
CROMADO CROMO CHROME	PRETO MATE NEGRO MATE MATT BLACK	REF	<b>FLEXÍVEL DUPLA GRAFATURA 150CM</b>	
X = 2	X = 3		Manguera de ducha de mano 150cm Shower flexible hose 150cm	
14 €	22 €	5061702x		
CROMADO CROMO CHROME	PRETO MATE NEGRO MATE MATT BLACK	REF	<b>FLEXÍVEL PVC ANTI-TORSÃO 150CM</b>	
X = 2	X = 3		Manguera de ducha PVC anti-torsión 150cm PVC anti-torsion shower flexible hose 150cm	
18 €	26 €	5061704x		

**TORNEIRA DE ESQUADRIA 1/2"x3/8"**

REF

CROMADO  
CROMO  
CHROME

PRETO MATE  
NEGRO MATE  
MATT BLACK

Grifo de escuadra de 1/2"x3/8"  
Cutting tap 1/2"x3/8"

X = 2

X = 3

5066219x

45 €

68 €

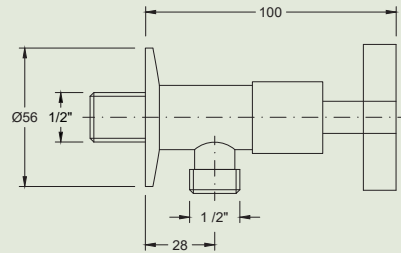

**TORNEIRA DE ESQUADRIA 1/2"x1/2"**

REF

CROMADO  
CROMO  
CHROME

PRETO MATE  
NEGRO MATE  
MATT BLACK

Grifo de escuadra de 1/2"x1/2"  
Cutting tap 1/2"x1/2"

X = 2

X = 3

5066229x

45 €

68 €

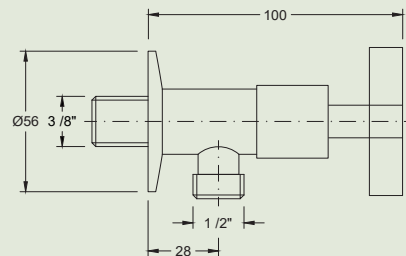

**TORNEIRA DE PASSAGEM DE 1/2"**

REF

CROMADO  
CROMO  
CHROME

PRETO MATE  
NEGRO MATE  
MATT BLACK

Grifo de corte empotrado de 1/2"  
Wall-mounted cutting tap 1/2"

X = 2

X = 3

5066239x

46 €

71 €

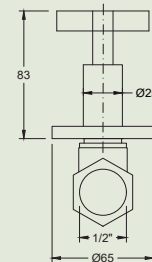

CROMADO  
CROMO  
CHROME

PRETO MATE  
NEGRO MATE  
MATT BLACK

REF

**TORNEIRA DE PASSAGEM DE 3/4"**

X = 2

X = 3

Grifo de corte empotrado de 3/4"  
Wall-mounted cutting tap 3/4"

52 €

78 €

5066249x

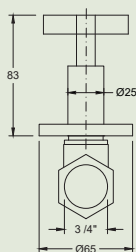

CROMADO  
CROMO  
CHROME

PRETO MATE  
NEGRO MATE  
MATT BLACK

REF

**MISTURADORA DE COZINHA  
C/ BICA ROTATIVA**

X = 2

X = 3

Mezclador de cocina con caño giratorio  
Kitchen mixer with rotating spout

262 €

393 €

5066258x

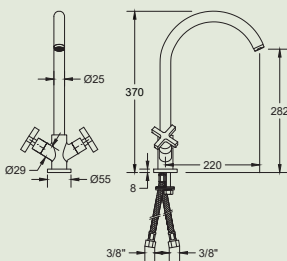

CROMADO  
CROMO  
CHROME

PRETO MATE  
NEGRO MATE  
MATT BLACK

REF

**SIFÃO CILÍNDRICO**

X = 2

X = 3

Sifón cilíndrico  
Cilindric Siphon

52 €

74 €

5510913x

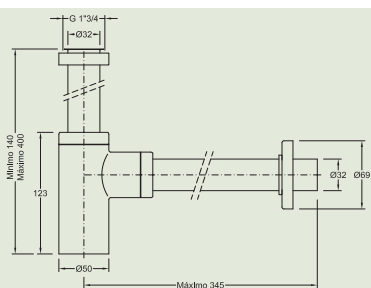

CROMADO  
CROMO  
CHROME

PRETO MATE  
NEGRO MATE  
MATT BLACK

REF

**VÁLVULA CLIC-CLAC**

X = 2

X = 3

Válvula clic-clac  
Pop-up waste

20 €

28 €

55110022

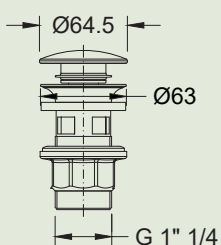

**MONOCOMANDO DE LAVATÓRIO C/ VCC**

REF

CROMADO CROMO CHROME

PRETO MATE NEGRO MATE BLACK MATE

NÍQUEL ESCOVADO NÍQUEL PULIDO BRUSHED NICKEL

Monocomando de Lavabo c/ VCC  
Single Lever Washbasin Mixer w/ VCC

5069502x

X = 2

X = 3

X = 0

163 €

212 €

326 €

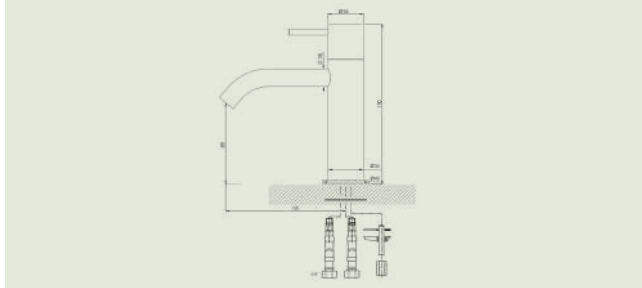

**MONOCOMANDO DE LAVATÓRIO ALTO C/ VCC**

REF

CROMADO CROMO CHROME

PRETO MATE NEGRO MATE BLACK MATE

NÍQUEL ESCOVADO NÍQUEL PULIDO BRUSHED NICKEL

Monocomando de Lavabo Alto c/ VCC  
Bowl Mixer w/ VCC

5069512x

X = 2

X = 3

X = 0

210 €

273 €

420 €

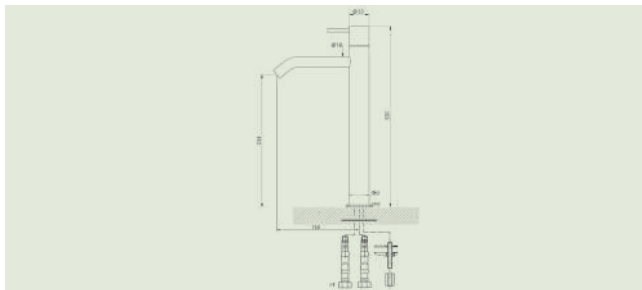

**MONOCOMANDO DE LAVATÓRIO MURAL C/ VCC**

REF

CROMADO CROMO CHROME

PRETO MATE NEGRO MATE BLACK MATE

NÍQUEL ESCOVADO NÍQUEL PULIDO BRUSHED NICKEL

Monocomando lavabo mural c/ VCC  
Wall mounted washbasin mixer w/ VCC

5069582xC

X = 2

X = 3

X = 0



225 €

250 €

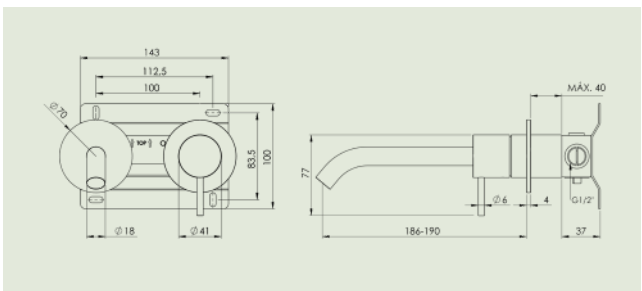
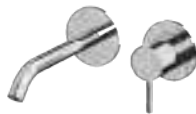

307 €

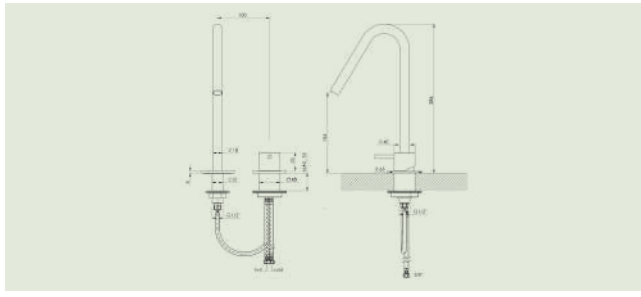

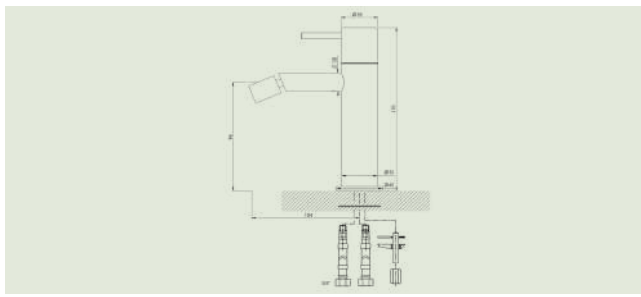

CROMADO CROMO CHROME	PRETO MATE NEGRO MATE BLACK MATE	NÍQUEL ESCOVADO NIQUEL PULIDO BRUSHED NICKEL	REF	MONOCOMANDO LAVATÓRIO DE BANCADA 2 FUROS C/ VCC
X = 2	X = 3	X = 0	5069542x	Monocomando de Lavabo de Encimera 2 Orifícios c/ VCC Single Lever Top Washbasin Mixer 2 Holes w/ VCC
252 €	328 €	504 €		

CROMADO CROMO CHROME	PRETO MATE NEGRO MATE BLACK MATE	NÍQUEL ESCOVADO NIQUEL PULIDO BRUSHED NICKEL	REF	MONOCOMANDO DE BIDÉ C/ VCC
X = 2	X = 3	X = 0	5069504x	Monocomando de Bidé c/ VCC Single Lever Bidet Mixer w/ VCC
163 €	212 €	326 €		

CROMADO CROMO CHROME	PRETO MATE NEGRO MATE BLACK MATE	NÍQUEL ESCOVADO NIQUEL PULIDO BRUSHED NICKEL	REF	MONOCOMANDO BANHEIRA
X = 2	X = 3	X = 0	5069505x	Monocomando de Banheira Single Lever Bath Mixer
292 €	409 €	614 €		

**MONOCOMANDO DE CHÃO P/  
BANHEIRA C/ KIT DE DUCHE**

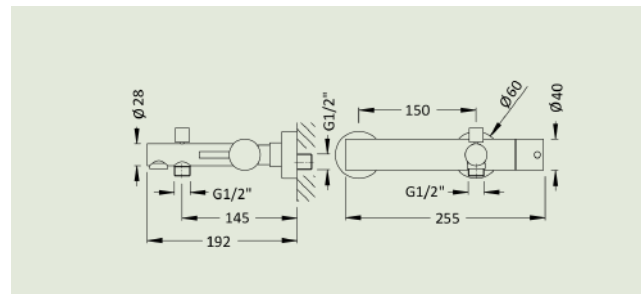
REF

CROMADO  
CROMO  
CHROME

PRETO MATE  
NEGRO MATE  
BLACK MATE

NÍQUEL ESCOVADO  
NÍQUEL PULIDO  
BRUSHED NICKEL

Monocomando de suelo para bañera c/  
kit de ducha  
Floor bath mixer w/ shower kit

5069525xC

X = 2

X = 3

X = 0

1.423 €

1.734 €

2.459 €

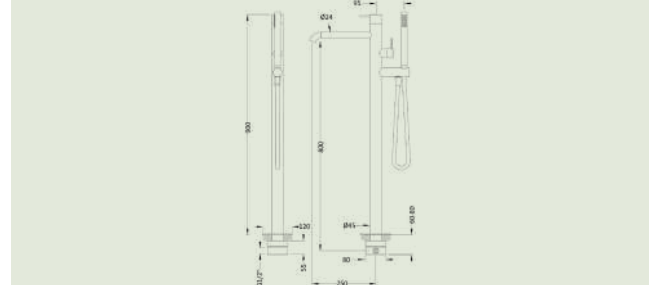

**MONOCOMANDO DE DUCHE C/ KIT  
DE CHUVEIRO**

REF

CROMADO  
CROMO  
CHROME

PRETO MATE  
NEGRO MATE  
BLACK MATE

NÍQUEL ESCOVADO  
NÍQUEL PULIDO  
BRUSHED NICKEL

Monocomando de ducha con kit de  
ducha  
Single lever shower mixer with shower  
kit

5069506x

X = 2

X = 3

X = 0

266 €

346 €

532 €

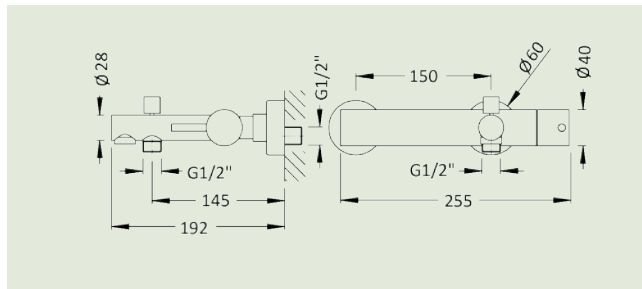
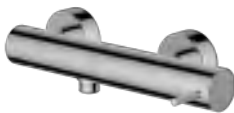

**MONOCOMANDO DE DUCHE 1 VIA**

REF

CROMADO  
CROMO  
CHROME

PRETO MATE  
NEGRO MATE  
BLACK MATE

NÍQUEL ESCOVADO  
NÍQUEL PULIDO  
BRUSHED NICKEL

Monocomando de ducha 1 via  
Shower mixer 1 way

5069567xC

X = 2

X = 3

X = 0

138 €

151 €

180 €

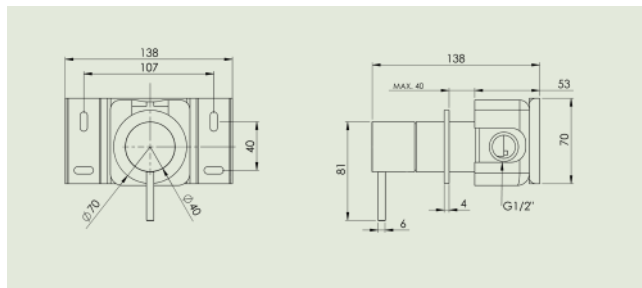

CROMADO CROMO CHROME

PRETO MATE NEGRO MATE BLACK MATE

NÍQUEL ESCOVADO NÍQUEL PULIDO BRUSHED NICKEL

REF

**MONOCOMANDO DE DUCHE 2 VIAS C/ KIT DE CHUVEIRO**

X = 2

X = 3

X = 0

Monocomando de ducha 2 vias c/ kit de ducha  
Shower mixer 2 ways w/ shower kit

342 €

390 €

499 €

5069557xC

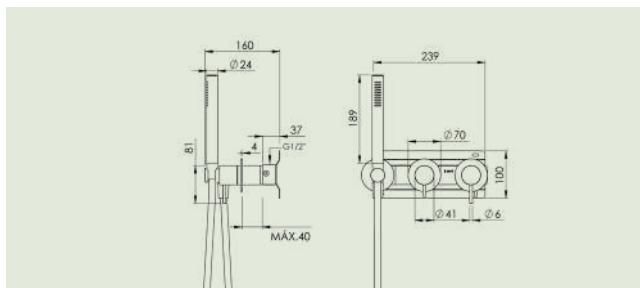

CROMADO CROMO CHROME

PRETO MATE NEGRO MATE BLACK MATE

NÍQUEL ESCOVADO NÍQUEL PULIDO BRUSHED NICKEL

REF

**MONOCOMANDO DE DUCHE 3 VIAS C/ KIT DE CHUVEIRO**

X = 2

X = 3

X = 0

Monocomando de ducha 3 vias c/ kit de ducha  
Shower mixer 3 ways w/ hand shower kit

351 €

399 €

508 €

5069577xC

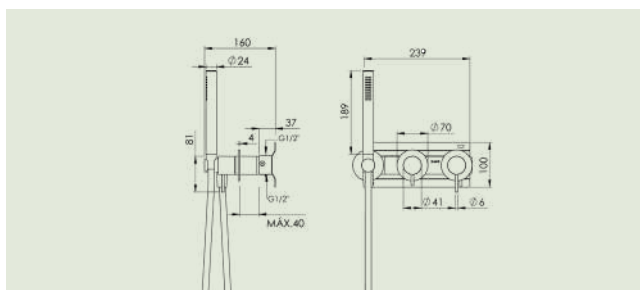

CROMADO CROMO CHROME

PRETO MATE NEGRO MATE BLACK MATE

NÍQUEL ESCOVADO NÍQUEL PULIDO BRUSHED NICKEL

REF

**BICA DE BANHEIRA DE ENCASTRAR**

X = 2

X = 3

X = 0

Bica de Bañera Empotrable  
Wall-Mounted Bath Spout

76 €

99 €

152 €

5069555x

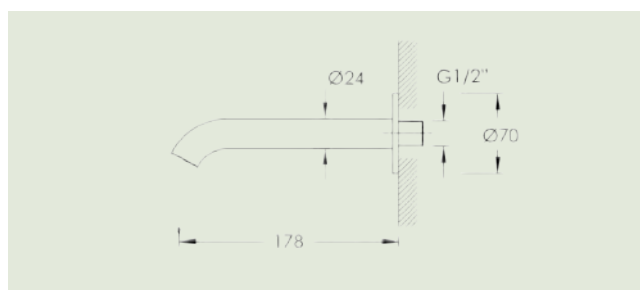

**MONOCOMANDO C/ KIT HIGIÉNICO**

REF

CROMADO  
CROMO  
CHROME

PRETO MATE  
NEGRO MATE  
BLACK MATE

NÍQUEL ESCOVADO  
NIQUEL PULIDO  
BRUSHED NICKEL

Monocomando c/ kit de aseo  
Wall mounted w/ hygienic kit

5069514xC

X = 2

X = 3

X = 0

255 €

289 €

367 €

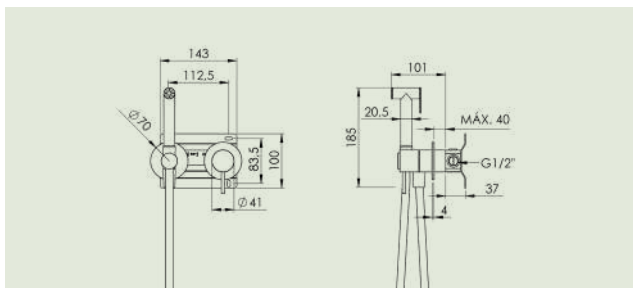

**TOMADA DE ÁGUA K/ KIT DE CHUVEIRO DE MÃO**

REF

CROMADO  
CROMO  
CHROME

PRETO MATE  
NEGRO MATE  
BLACK MATE

NÍQUEL ESCOVADO  
NIQUEL PULIDO  
BRUSHED NICKEL

Conexión de Agua con Kit de  
Ducha de Mano  
Wall Mounted Water Outlet  
Connector w/ Hand Shower Kit

5069547x

X = 2

X = 3

X = 0

104 €

136 €

208 €

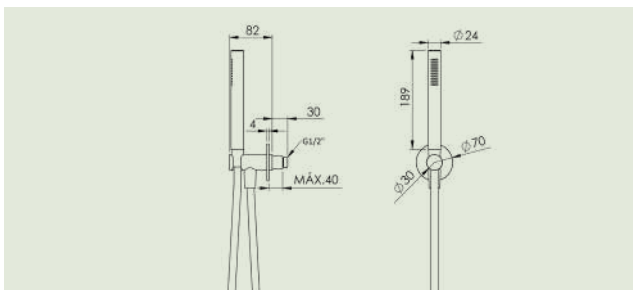

**MONOCOMANDO DE COZINHA C/ BICA ROTATIVA**

REF

CROMADO  
CROMO  
CHROME

PRETO MATE  
NEGRO MATE  
BLACK MATE

NÍQUEL ESCOVADO  
NIQUEL PULIDO  
BRUSHED NICKEL

Monocomando de Cozinha com Caño Giratorio  
Kitchen Mixer with Rotating Spout

5069548x

X = 2

X = 3

X = 0

224 €

292 €

448 €

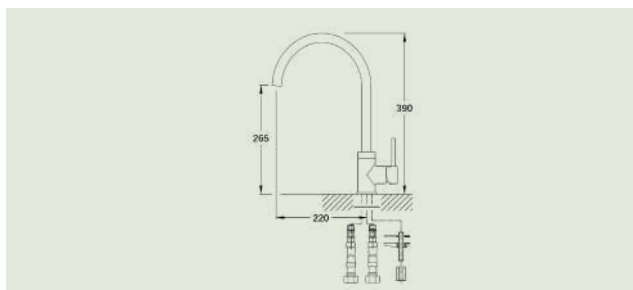



CROMADO  
CROMO  
CHROME

PRETO MATE  
NEGRO MATE  
BLACK MATE

NÍQUEL ESCOVADO  
NIQUEL PULIDO  
BRUSHED NICKEL

REF

SIFÃO CILÍNDRICO

X = 2

X = 3

X = 0

Sifón Cilíndrico  
Cilindric Siphon

51 €

67 €

102 €

5510915x

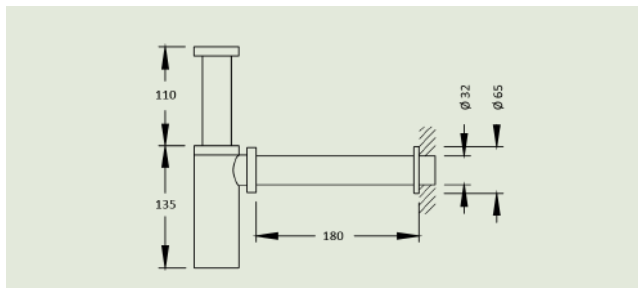

CROMADO  
CROMO  
CHROME

PRETO MATE  
NEGRO MATE  
BLACK MATE

NÍQUEL ESCOVADO  
NIQUEL PULIDO  
BRUSHED NICKEL

REF

CHUVEIRO DE TECTO 200MM

X = 2

X = 3

X = 0

Ducha de techo 200mm  
Head shower 200mm

140 €

182 €

280 €

5068321x

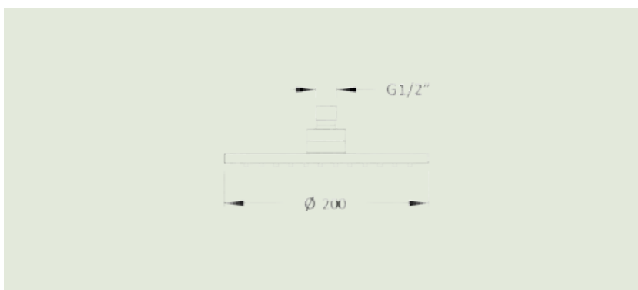

CROMADO  
CROMO  
CHROME

PRETO MATE  
NEGRO MATE  
BLACK MATE

NÍQUEL ESCOVADO  
NIQUEL PULIDO  
BRUSHED NICKEL

REF

HASTE DE TECTO 170MM

X = 2

X = 3

X = 0

Barra de Techo 170mm  
Ceiling Rod 170mm

31 €

41 €

62 €

5069721x

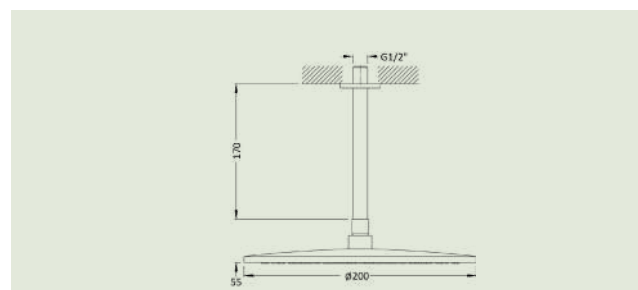

CROMADO  
CROMO  
CHROME

PRETO MATE  
NEGRO MATE  
BLACK MATE

NÍQUEL ESCOVADO  
NIQUEL PULIDO  
BRUSHED NICKEL

REF

HASTE DE PAREDE 350MM

X = 2

X = 3

X = 0

Barra Mural 350mm  
Wall Rod 350mm

84 €

110 €

168 €

5069743x

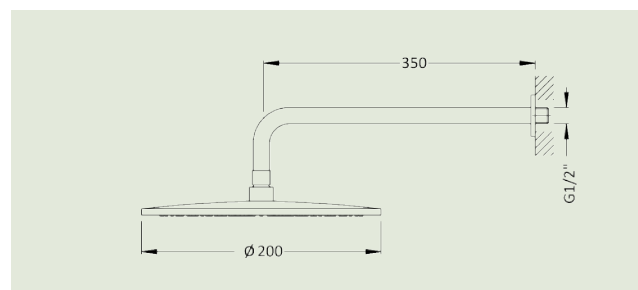

**MONOCOMANDO DE LAVATÓRIO C/VCC**

REF

CROMADO CROMO CHROME

PRETO MATE NEGRO MATE BLACK MATE

Monocomando de lavabo c / VCC  
Single lever washbasin mixer with VCC

X = 2

X = 3

5061302x

206 €

309 €

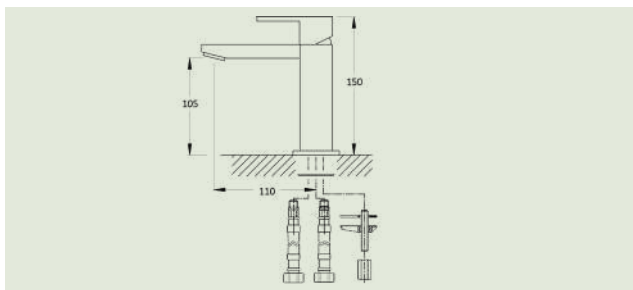

**MONOCOMANDO DE LAVATÓRIO MURAL ESPELHOS QUADRADOS C/VCC**

REF

CROMADO CROMO CHROME

PRETO MATE NEGRO MATE BLACK MATE

Monocomando de lavabo mural 2 espejos cuadrados c / VCC  
Single lever wall mounted basin mixer with 2 square mirrors and VCC

X = 2

X = 3

5061332x

322 €

485 €

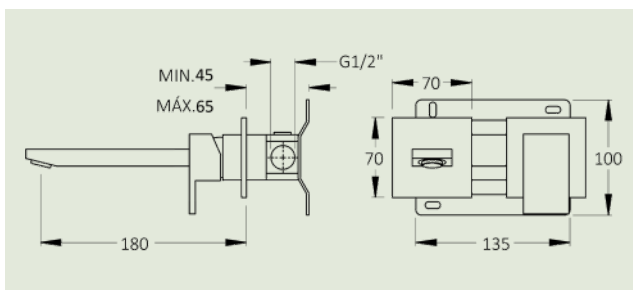

**MONOCOMANDO DE BIDÉ C/VCC**

REF

CROMADO CROMO CHROME

PRETO MATE NEGRO MATE BLACK MATE

Monocomando de bidé c / VCC  
Single lever bidet mixer with VCC

X = 2

X = 3

5061304x

206 €

309 €

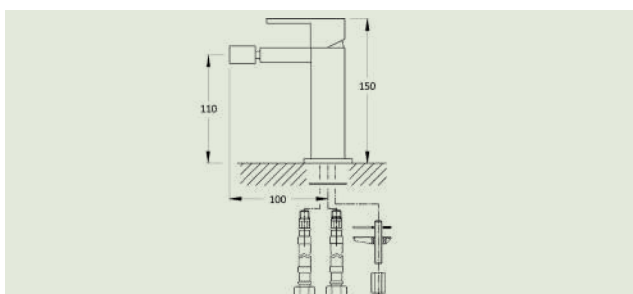

CROMADO  
CROMO  
CHROME

PRETO MATE  
NEGRO MATE  
BLACK MATE

REF

**MONOCOMANDO DE BANHEIRA C/ KIT DE CHUVEIRO MANUAL**

X = 2

X = 3

334 €

501 €

5061305x

Monocomando de bañeira con kit de ducha manual  
Single lever bath mixer with shower kit

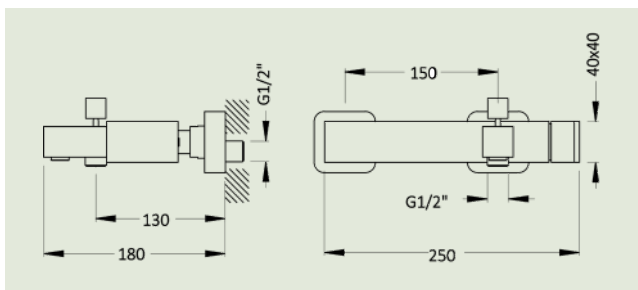

CROMADO  
CROMO  
CHROME

PRETO MATE  
NEGRO MATE  
BLACK MATE

REF

**MONOCOMANDO DE BASE DE DUCHE C/ KIT DE CHUVEIRO MANUAL**

X = 2

X = 3

305 €

458 €

5061306x

Monocomando de ducha con kit de ducha manual  
Single lever shower mixer with shower kit

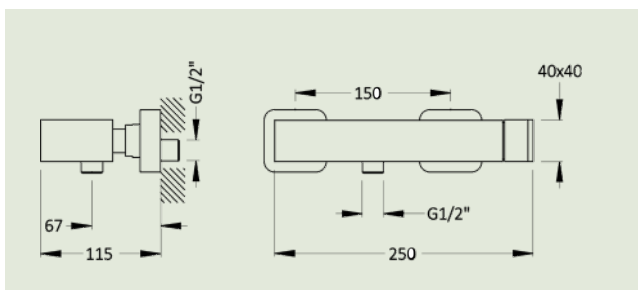

CROMADO  
CROMO  
CHROME

PRETO MATE  
NEGRO MATE  
BLACK MATE

REF

**MONOCOMANDO DUCHE MURAL**

X = 2

X = 3

179 €

268 €

5061307x

Monocomando ducha mural  
Wall mounted single lever shower mixer

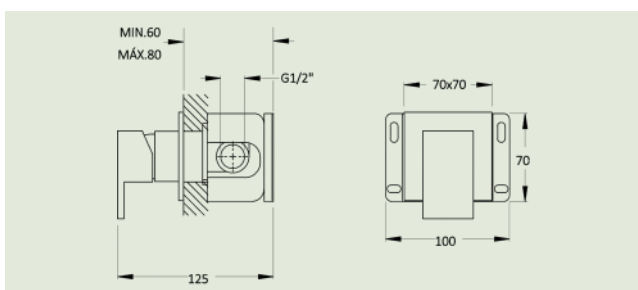

**MONOCOMANDO BANHO/  
DUCHE MURAL**

REF

CROMADO  
CROMO  
CHROME

PRETO MATE  
NEGRO MATE  
BLACK MATE

Monocomando baño/ducha mural  
Wall mounted single lever bath/shower  
mixer

5061317x

X = 2

X = 3

249 €

373 €

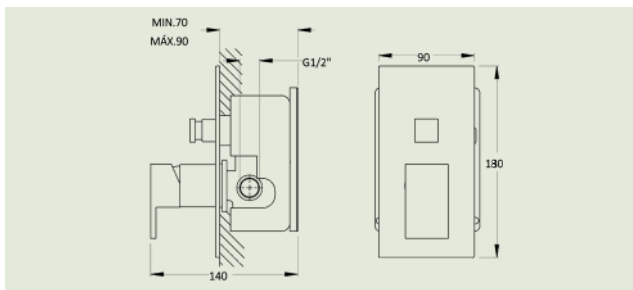

**MONOCOMANDO DE DUCHE 2 VIAS  
DE EMBUTIR C/ KIT DE CHUVEIRO**

REF

CROMADO  
CROMO  
CHROME

PRETO MATE  
NEGRO MATE  
BLACK MATE

Monocomando ducha mural 2 vías c /  
kit de ducha manual  
Wall-mounted shower mixer with 2  
ways diverter and shower kit

5061327x

X = 2

X = 3

411 €

616 €

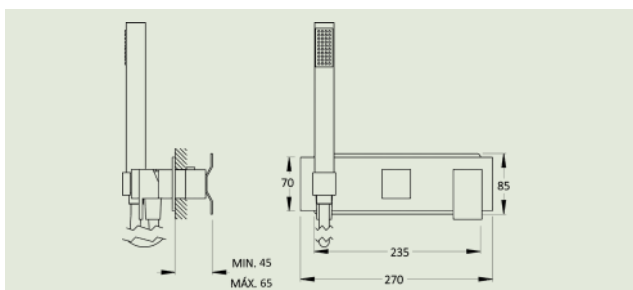

**MONOCOMANDO DE EMBUTIR C/ KIT  
HIGIÉNICO**

REF

CROMADO  
CROMO  
CHROME

PRETO MATE  
NEGRO MATE  
BLACK MATE

Monocomando de embutir c / kit  
higiénico  
Wall-mounted single lever mixer with  
hygienic kit

5061314x

X = 2

X = 3

271 €

406 €

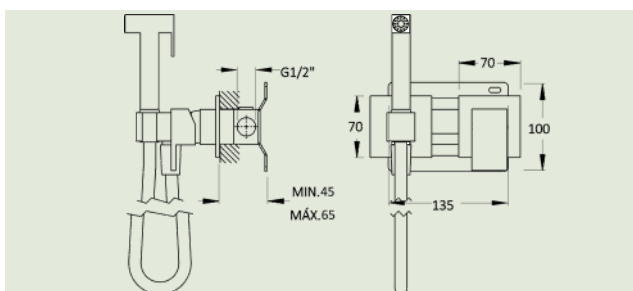

CROMADO  
CROMO  
CHROME

PRETO MATE  
NEGRO MATE  
BLACK MATE

REF

**MONOCOMANDO DE DUCHE C/  
COLUNA TELESCÓPICA E CHUVEIRO  
QUADRADO DE 200MM**

X = 2

X = 3

912 €

1.369 €

5061367x

Monocomando de ducha c/ columna telescópica y ducha cuadrado 200mm  
Shower mixer with telescopic column and square shower 200mm

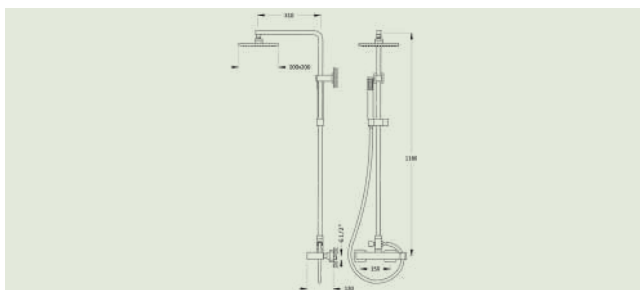

CROMADO  
CROMO  
CHROME

PRETO MATE  
NEGRO MATE  
BLACK MATE

REF

**SIFÃO QUADRADO**

X = 2

X = 3

71 €

105 €

5510914x

Sifón cuadrado  
Square Siphon

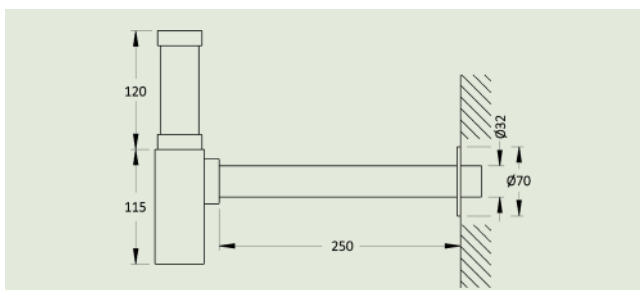

CROMADO  
CROMO  
CHROME

PRETO MATE  
NEGRO MATE  
BLACK MATE

REF

**VÁLVULA CLIC-CLAC**

X = 2

X = 3

20 €

29 €

5511005x

Válvula clic-clac  
Pop-up waste

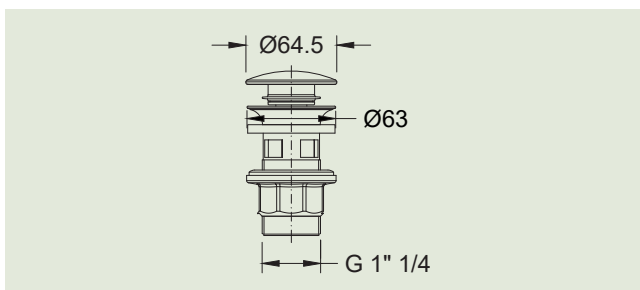

**MONOCOMANDO DE DUCHE 3 VIAS DE EMBUTIR C/ KIT DE CHUVEIRO**

REF

CROMADO  
CROMO  
CHROME

PRETO MATE  
NEGRO MATE  
BLACK MATE

Monocomando ducha mural 3 vías c / kit de ducha manual  
Wall mounted shower mixer with 3 ways diverter and shower kit

5061337x

X = 2

X = 3

477 €

715 €

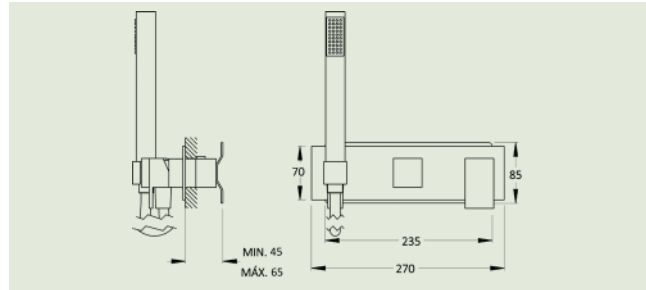

**TOMADA DE ÁGUA C/ KIT DE CHUVEIRO DE MÃO**

REF

CROMADO  
CROMO  
CHROME

PRETO MATE  
NEGRO MATE  
BLACK MATE

Conexión de agua con kit de ducha de mano  
Wall mounted water outlet connector with hand shower kit

5061397x

X = 2

X = 3

119 €

179 €

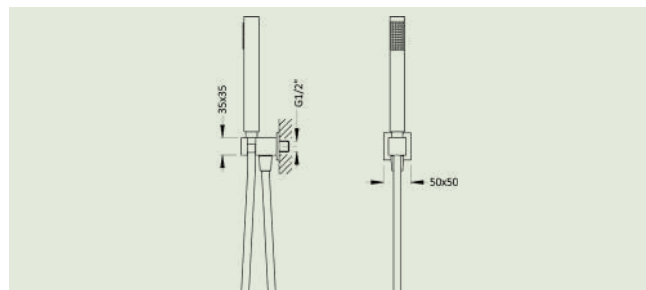

CROMADO  
CROMO  
CHROME

DOURADO  
DORADO  
GOLDEN

DOURADO MATE  
ORO MATE  
MATT GOLD

REF

**MISTURADORA DE LAVATÓRIO C/ VDA**

X = 2

X = 4

X = 5

142 €

283 €

283 €

5063502x

Mezcladora de lavabo c / VDA  
Washbasin mixer w/ automatic waste

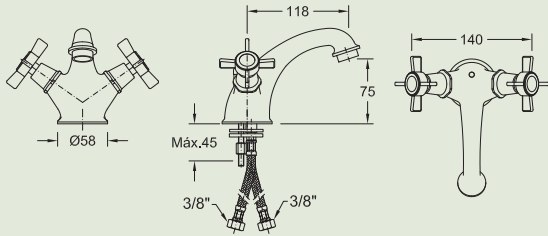

CROMADO  
CROMO  
CHROME

DOURADO  
DORADO  
GOLDEN

DOURADO MATE  
ORO MATE  
MATT GOLD

REF

**MISTURADORA DE LAVATÓRIO  
3 FUROS C/ VDA**

X = 2

X = 4

X = 5

256 €

510 €

510 €

5063531x

Mezcladora de lavabo 3 agujeros c / VDA  
Three holes washbasin mixer w/  
automatic waste

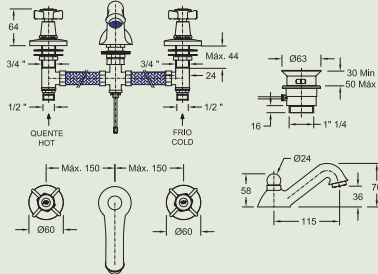

CROMADO  
CROMO  
CHROME

DOURADO  
DORADO  
GOLDEN

DOURADO MATE  
ORO MATE  
MATT GOLD

REF

**MISTURADORA DE LAVATÓRIO MURAL  
C/ VÁLVULA CLIC-CLAC**

X = 2

X = 4

X = 5

197 €

393 €

393 €

5063522x

Mezcladora de lavabo mural c/  
válvula clic-clac  
Wall-mounted washbasin mixer w/  
pop-up waste

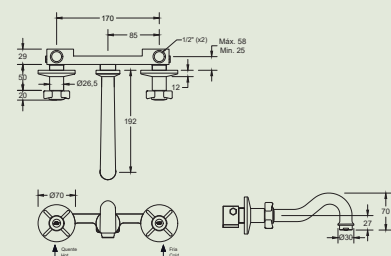

CROMADO  
CROMO  
CHROME

DOURADO  
DORADO  
GOLDEN

DOURADO MATE  
ORO MATE  
MATT GOLD

REF

**MISTURADORA DE BIDÉ C/ VDA**

X = 2

X = 4

X = 5

145 €

288 €

288 €

5063504x

Mezclador de bidé c/ VDA  
Bidet mixer w/ automatic waste

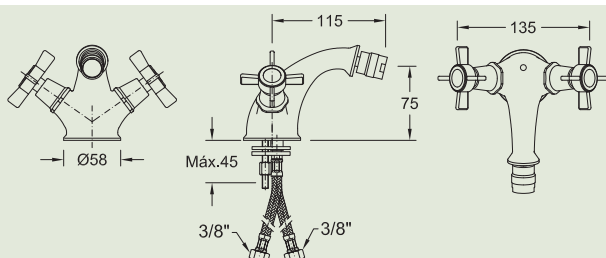

**MISTURADORA DE BIDÉ  
3 FUROS C/ VDA**

REF

Mezcladora de bidé 3 agujeros c/ VDA  
Three holes bidet mixer w/ automatic  
waste

5063534x



CROMADO  
CROMO  
CHROME

DOURADO  
DORADO  
GOLDEN

DOURADO MATE  
ORO MATE  
MATT GOLD

X = 2

X = 4

X = 5

258 €

516 €

516 €

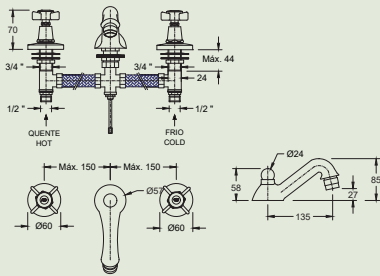

**MISTURADORA DE BANHEIRA C/ KIT  
DE CHUVEIRO MANUAL (8L/MIN.)**

REF

Mezcladora de bañera con kit de ducha  
manual (8L/min.)  
Bath mixer w/ shower kit (8L/min.)

5063505x



CROMADO  
CROMO  
CHROME

DOURADO  
DORADO  
GOLDEN

DOURADO MATE  
ORO MATE  
MATT GOLD

X = 2

X = 4

X = 5

242 €

510 €

510 €

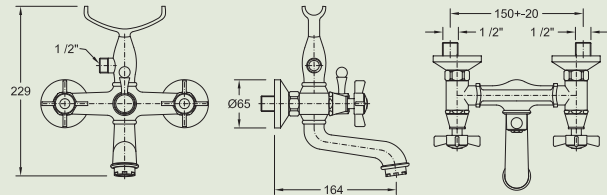

**MISTURADORA DE BANHEIRA DE  
CHÃO C/ KIT DE CHUVEIRO MANUAL  
(8L/MIN.)**

REF

Mezcladora de bañera de suelo con kit  
de ducha manual (8L/min.)  
Floor bath mixer w/ shower kit (8L/min.)

5063515x

CROMADO  
CROMO  
CHROME

DOURADO  
DORADO  
GOLDEN

DOURADO MATE  
ORO MATE  
MATT GOLD

X = 2

X = 4

X = 5

517 €

1.084 €

1.084 €

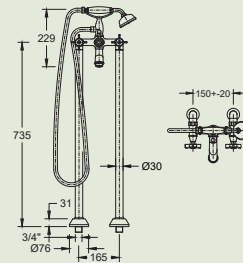

**MISTURADORA DE DUCHE C/ KIT DE  
CHUVEIRO MANUAL (8L/MIN.)**

REF

Mezcladora de ducha con kit de ducha  
manual (8L/min.)  
Shower mixer w/ shower kit (8L/min.)

5063506x



CROMADO  
CROMO  
CHROME

DOURADO  
DORADO  
GOLDEN

DOURADO MATE  
ORO MATE  
MATT GOLD

X = 2

X = 4

X = 5

151 €

317 €

317 €

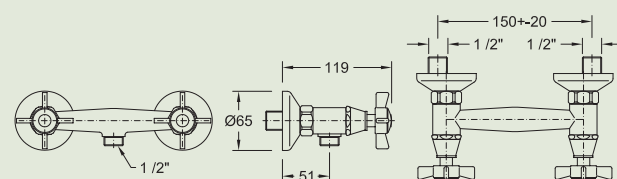



CROMADO CROMO CHROME	DOURADO DORADO GOLDEN	DOURADO MATE ORO MATE MATT GOLD	REF	MISTURADORA DE DUCHE MURAL
X = 2	X = 4	X = 5		Mezcladora de Ducha Mural Wall-mounted Shower Mixer
119 €	236 €	236 €	5063507x	

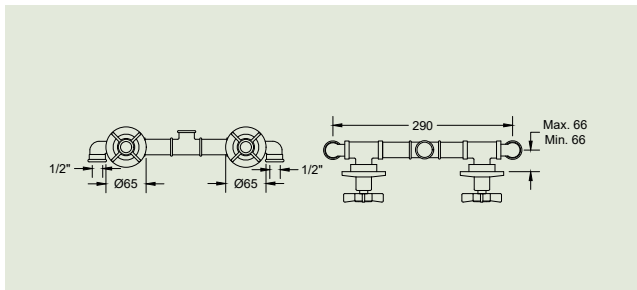

CROMADO CROMO CHROME	DOURADO DORADO GOLDEN	DOURADO MATE ORO MATE MATT GOLD	REF	MISTURADORA DE DUCHE DE ENCASTRAR C/ INVERSOR 2 VIAS
X = 2	X = 4	X = 5		Mezclador empotrado de ducha con inverter 2 vías Wall-mounted shower mixer with 2-way inverter
199 €	397 €	397 €	5063527x	

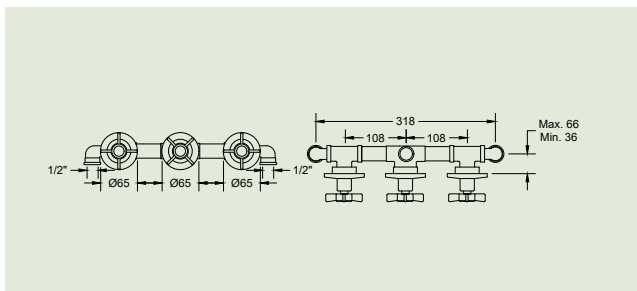

CROMADO CROMO CHROME	DOURADO DORADO GOLDEN	DOURADO MATE ORO MATE MATT GOLD	REF	MISTURADORA DE DUCHE DE ENCASTRAR C/ INVERSOR 3 VIAS
X = 2	X = 4	X = 5		Mezclador empotrado de ducha con inverter 3 vías Wall-mounted shower mixer with 3-way inverter
225 €	447 €	447 €	5063537x	

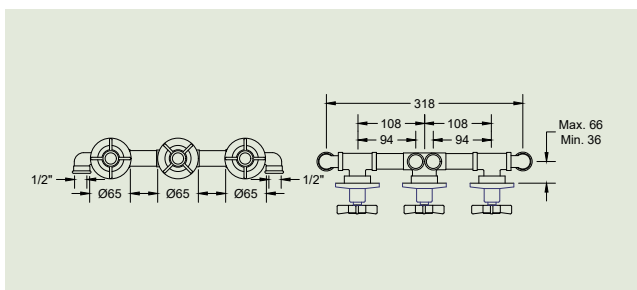

CROMADO CROMO CHROME	DOURADO DORADO GOLDEN	DOURADO MATE ORO MATE MATT GOLD	REF	MISTURADORA DE BANHEIRA DE COLUNA C/ CHUVEIRO SUPERIOR E KIT DE CHUVEIRO MANUAL
X = 2	X = 4	X = 5		Mezcladora de bañeira de coluna com ducha superior y kit de ducha manual Bath mixer w/ column and shower kit
620 €	1.363 €	1.363 €	5063525x	

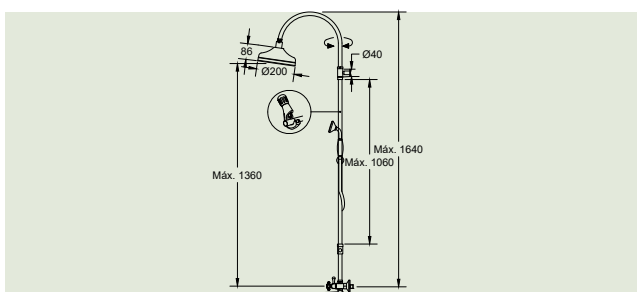

**MISTURADORA DE DUCHE DE COLUNA C/ CHUVEIRO SUPERIOR E KIT DE CHUVEIRO MANUAL**

REF

CROMADO CROMO CHROME

DOURADO DORADO GOLDEN

DOURADO MATE ORO MATE MATT GOLD

Mezcladora de ducha de columna con ducha superior y kit de ducha manual  
Shower mixer w/ column and shower kit

5063547x

X = 2

X = 4

X = 5

517 €

1.137 €

1.137 €

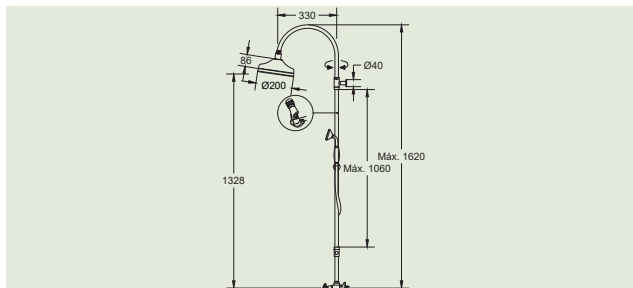

**CHUVEIRO DE MÃO (8L/MIN.)**

REF

CROMADO CROMO CHROME

DOURADO DORADO GOLDEN

DOURADO MATE ORO MATE MATT GOLD

Ducha de mano (8L/min.)  
Hand shower (8L/min.)



X = 2

X = 4

X = 5

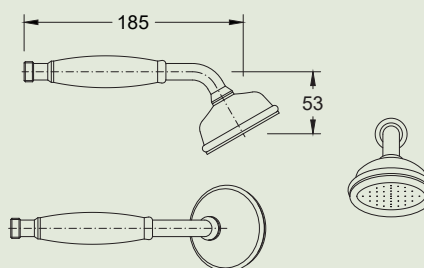

5063591x

51 €

101 €

101 €

**SUPORTE DE CHUVEIRO**

Soporte de ducha  
Shower holder

5063500x

21 €

41 €

41 €

**TOMADA DE ÁGUA C/ SUPORTE DE CHUVEIRO**

REF

CROMADO CROMO CHROME

DOURADO DORADO GOLDEN

DOURADO MATE ORO MATE MATT GOLD

Conexión de agua com soporte de ducha de mano  
Water outlet w/ hand shower support

5063592x

X = 2

X = 4

X = 5

53 €

105 €

105 €

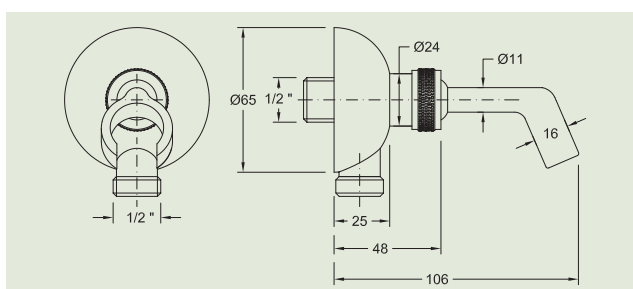

CROMADO CROMO CHROME	DOURADO DORADO GOLDEN	DOURADO MATE ORO MATE MATT GOLD	REF	
X = 2	X = 4	X = 5		<b>CHUVEIRO DE TECTO EM LATÃO (8L/MIN.)</b>
173 €	342 €	342 €	5063593x	Ducha de techo en laton (8L/min.) Brass head shower (8L/min.)
X = 2	X = 4	X = 5		<b>FLEXÍVEL DUPLA GRAFATURA 150CM</b>
14 €	28 €	28 €	5061702x	Manguera de ducha de mano 150cm Shower flexible hose 150cm
X = 2	X = 4	X = 5		<b>FLEXÍVEL PVC ANTI-TORSÃO 150CM</b>
18 €	41 €	41 €	5061704x	Manguera de ducha PVC anti-torsión 150cm PVC anti-torsion shower flexible hose 150cm
X = 2	X = 4	X = 5		<b>VÁLVULA CLIC-CLAC</b>
20 €	28 €	28 €	5511002x	Válvula clic-clac Pop-up waste
X = 2	X = 4	X = 5		<b>VÁLVULA DE DESCARGA AUTOMÁTICA</b>
34 €	67 €	67 €	5063590x	Válvula de desague automática Automatic discharge valve
X = 2	X = 4	X = 5		<b>TORNEIRA DE PASSAGEM DE 1/2"</b>
41 €	80 €	80 €	5063540x	Grifo de corte de 1/2 " Cutting tap 1/2"
X = 2	X = 4	X = 5		<b>TORNEIRA DE PASSAGEM DE 3/4"</b>
53 €	105 €	105 €	5063543x	Grifo de corte de 3/4 " Cutting tap 3/4"
X = 2	X = 4	X = 5		<b>TORNEIRA DE ESQUADRIA 1/2"x3/8"</b>
41 €	80 €	80 €	5063544x	Grifo de escuadra 1/2"x3/8" Cutting tap 1/2"x3/8"
X = 2	X = 4	X = 5		<b>TORNEIRA DE ESQUADRIA 1/2"x1/2"</b>
41 €	80 €	80 €	5063545x	Grifo de escuadra 1/2"x1/2" Cutting tap 1/2"x1/2"



**MONOCOMANDO DE LAVATÓRIO C/ VCC**

REF

CROMADO CROMO CHROME

PRETO MATE NEGRO MATE BLACK MATT

NIQUEL ESCOVADO NIQUEL PULIDO BRUSHED NICKEL

Monocomando de lavabo con VCC  
Single lever washbasin mixer with VCC

5061502x

X = 2

X = 3

X = 0

111 €

165 €

165 €

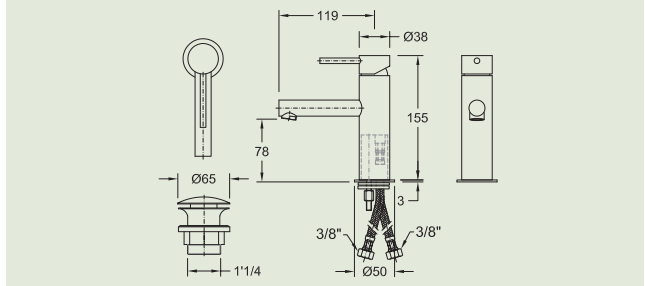

**MONOCOMANDO DE LAVATÓRIO C/ VCC PARA LAVATÓRIO EGG SUSPENSO**

REF

CROMADO CROMO CHROME

PRETO MATE NEGRO MATE BLACK MATT

NIQUEL ESCOVADO NIQUEL PULIDO BRUSHED NICKEL

Monomando de lavabo con VCC  
para lavabo EGG suspenso  
Single lever washbasin mixer with  
VCC for wall-hung EGG washbasin

5061532x

X = 2

X = 3

X = 0

151 €

227 €

227 €

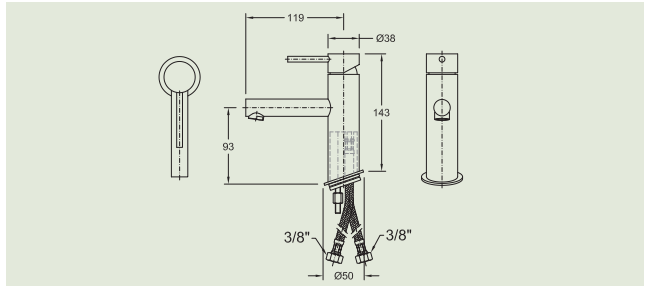

**MONOCOMANDO DE LAVATÓRIO ALTO C/ VCC**

REF

CROMADO CROMO CHROME

PRETO MATE NEGRO MATE BLACK MATT

NIQUEL ESCOVADO NIQUEL PULIDO BRUSHED NICKEL

Monocomando de lavabo alto c/ VCC  
Bowl mixer with VCC

5061512x

X = 2

X = 3

X = 0

174 €

259 €

259 €

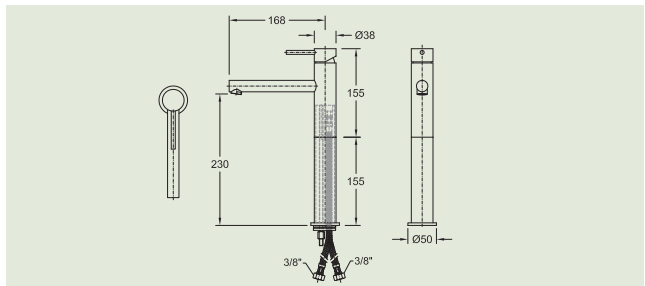

CROMADO CROMO CHROME	PRETO MATE NEGRO MATE BLACK MATT	NIQUEL ESCOVADO NIQUEL PULIDO BRUSHED NICKEL	REF	MONOCOMANDO DE LAVATÓRIO DE PAREDE C/ESPELHO RECTANGULAR E VCC
----------------------------	--	--	-----	--

X = 2	X = 3	X = 0	5061522x	Monocomando de lavabo de pared con espejo rectangular y VCC Wall-mounted single lever washbasin with rectangular mirror and VCC
190 €	286 €	286 €		

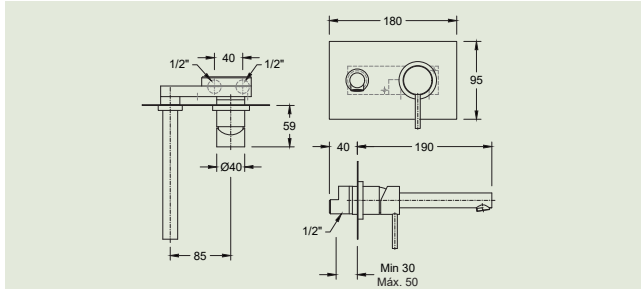

CROMADO CROMO CHROME	PRETO MATE NEGRO MATE BLACK MATT	NIQUEL ESCOVADO NIQUEL PULIDO BRUSHED NICKEL	REF	MONOCOMANDO DE LAVATÓRIO DE PAREDE C/ESPELHOS REDONDOS E VCC
----------------------------	--	--	-----	--

X = 2	X = 3	X = 0	5061562x	Monocomando de lavabo de pared con espejos redondos y VCC Wall-mounted single lever washbasin with round mirrors and VCC
161 €	242 €	242 €		

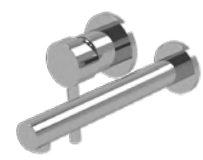
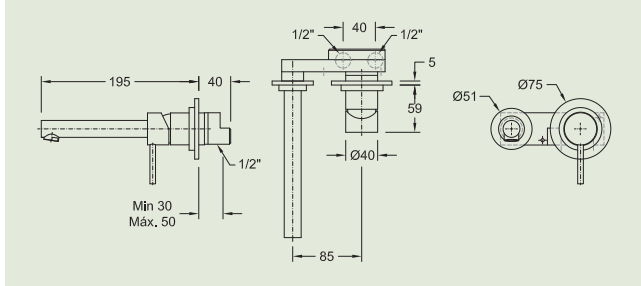

CROMADO CROMO CHROME	PRETO MATE NEGRO MATE BLACK MATT	NIQUEL ESCOVADO NIQUEL PULIDO BRUSHED NICKEL	REF	MONOCOMANDO DE BIDÉ C/ VCC
----------------------------	--	--	-----	----------------------------

X = 2	X = 3	X = 0	5061504x	Monocomando de bidé c/ VCC Single lever bidet mixer with VCC
114 €	173 €	173 €		

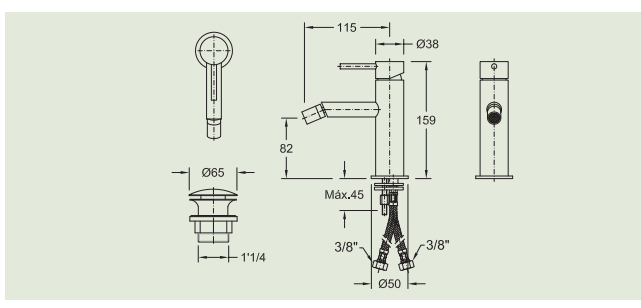

CROMADO CROMO CHROME	PRETO MATE NEGRO MATE BLACK MATT	NIQUEL ESCOVADO NIQUEL PULIDO BRUSHED NICKEL	REF	MONOCOMANDO DE BANHEIRA C/ KIT DE CHUVEIRO MANUAL
----------------------------	--	--	-----	--

X = 2	X = 3	X = 0	5061505x	Monocomando de bañera con kit de ducha manual Single lever bath mixer with shower kit
213 €	426 €	426 €		

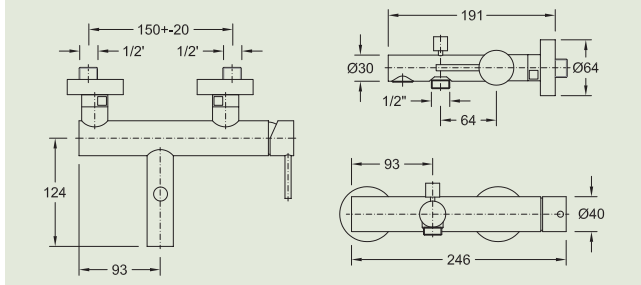

**MONOCOMANDO DE CHÃO DE BANHEIRA C/ KIT DE CHUVEIRO MANUAL**

REF

CROMADO CROMO CHROME

PRETO MATE NEGRO MATE BLACK MATT

NIQUEL ESCOVADO NIQUEL PULIDO BRUSHED NICKEL

Monocomando de suelo de bañera con kit de ducha manual  
Single lever floor bath mixer with shower kit

5062515x

X = 2

X = 3

X = 0

686 €

1.371 €

1.371 €

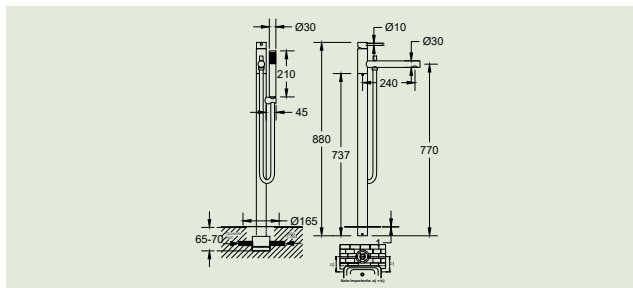

**MONOCOMANDO DE DUCHE C/ KIT DE CHUVEIRO MANUAL**

REF

CROMADO CROMO CHROME

PRETO MATE NEGRO MATE BLACK MATT

NIQUEL ESCOVADO NIQUEL PULIDO BRUSHED NICKEL

Monocomando de ducha con kit de ducha manual  
Single lever shower mixer with shower kit

5061506x

X = 2

X = 3

X = 0

181 €

362 €

362 €

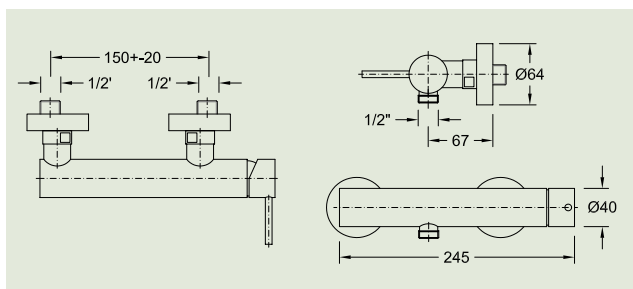

**MONOCOMANDO DE DUCHE MURAL**

REF

CROMADO CROMO CHROME

PRETO MATE NEGRO MATE BLACK MATT

NIQUEL ESCOVADO NIQUEL PULIDO BRUSHED NICKEL

Monocomando de ducha mural  
Wall-mounted single lever shower mixer

5061507x

X = 2

X = 3

X = 0

92 €

137 €

137 €

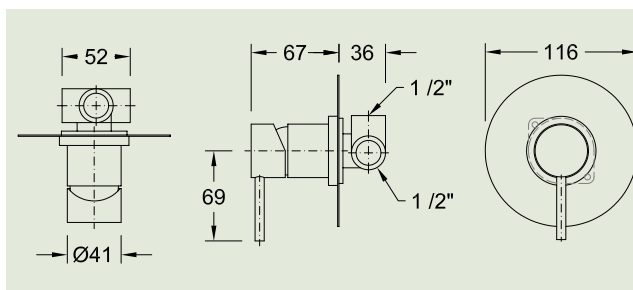

CROMADO  
CROMO  
CHROME

PRETO MATE  
NEGRO MATE  
BLACK MATT

NIQUEL ESCOVADO  
NIQUEL PULIDO  
BRUSHED NICKEL

REF

**MONOCOMANDO DE DUCHE MURAL  
C/ ESPELHOS REDONDOS E INVERSOR  
DE 2 VIAS E KIT DE CHUVEIRO**

X = 2

X = 3

X = 0

271 €

408 €

408 €

5062557x

Mezclador de ducha de pared con espejos redondos, inversor de 2 vías y kit de ducha  
Wall-mounted shower mixer with round mirrors and 2-way inverter and shower kit

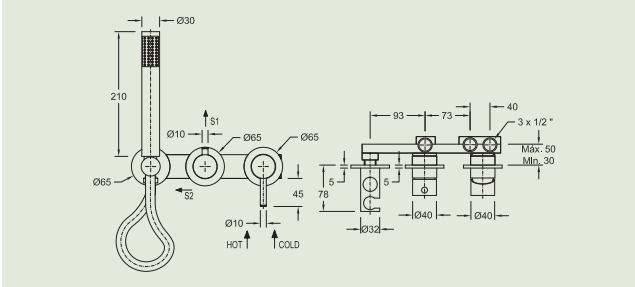

CROMADO  
CROMO  
CHROME

PRETO MATE  
NEGRO MATE  
BLACK MATT

NIQUEL ESCOVADO  
NIQUEL PULIDO  
BRUSHED NICKEL

REF

**MONOCOMANDO DE DUCHE MURAL  
C/ ESPELHOS REDONDOS E INVERSOR  
DE 3 VIAS E KIT DE CHUVEIRO**

X = 2

X = 3

X = 0

302 €

450 €

450 €

5062577x

Mezclador de ducha de pared con espejos redondos, inversor de 3 vías y kit de ducha  
Wall-mounted shower mixer with round mirrors and 3-way inverter and shower kit

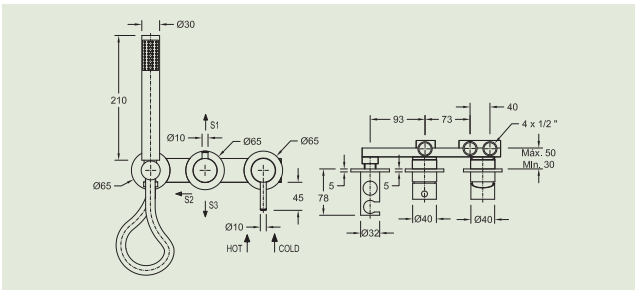

CROMADO  
CROMO  
CHROME

PRETO MATE  
NEGRO MATE  
BLACK MATT

NIQUEL ESCOVADO  
NIQUEL PULIDO  
BRUSHED NICKEL

REF

**MONOCOMANDO DE DUCHE MURAL  
C/ ESPELHO RETANGULAR E  
INVERSOR DE 3 VIAS E KIT DE CHUVEIRO**

X = 2

X = 3

X = 0

325 €

489 €

489 €

5061567x

Monocomando de ducha mural c/ espejos rectangular c/ distribuidor de 3 salidas  
Wall-mounted single lever shower mixer w/ rectangular mirrors w/ 3 ways diverter

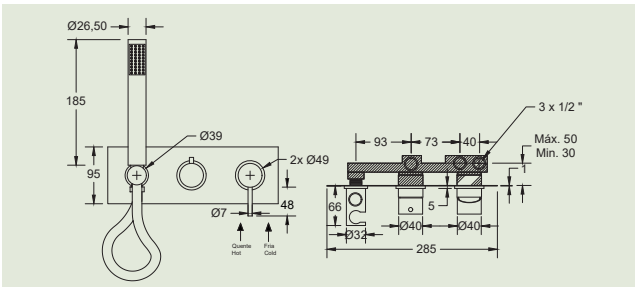

**TOMADA DE ÁGUA C/ SUPORTE PARA CHUVEIRO DE MÃO**

REF

CROMADO CROMO CHROME

PRETO MATE NEGRO MATE BLACK MATT

NIQUEL ESCOVADO NIQUEL PULIDO BRUSHED NICKEL

Conexión de agua con soporte de ducha de mano  
Water outlet w/ hand shower support

5517302x

X = 2

X = 3

X = 0

53 €

80 €

80 €

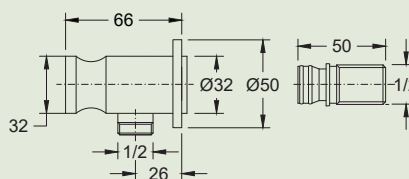

**MONOCOMANDO DE DUCHE MURAL C/ ESPELHO RECTANGULAR E INVERSOR DE 2 VIAS E KIT DE CHUVEIRO**

REF

CROMADO CROMO CHROME

PRETO MATE NEGRO MATE BLACK MATT

NIQUEL ESCOVADO NIQUEL PULIDO BRUSHED NICKEL

Monocomando de ducha mural con distribuidor rotativo de 2 salidas  
Wall-mounted single lever shower mixer w/ 2 ways diverter

5061547x

X = 2

X = 3

X = 0

303 €

454 €

454 €

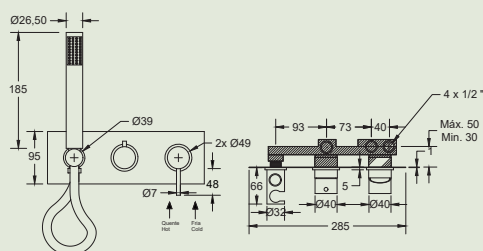

**HASTE DE PAREDE 35CM**

REF

CROMADO CROMO CHROME

PRETO MATE NEGRO MATE BLACK MATT

NIQUEL ESCOVADO NIQUEL PULIDO BRUSHED NICKEL

Barra mural para ducha com 35cm  
Wall rod 35cm

5069723x

X = 2

X = 3

X = 0

42 €

63 €

63 €

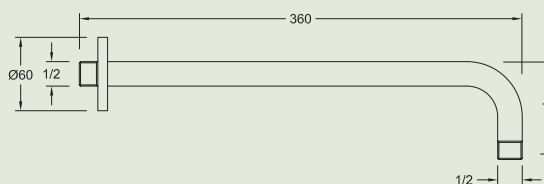

**HASTE DE TECTO DE 15CM**

REF

CROMADO CROMO CHROME

PRETO MATE NEGRO MATE BLACK MATT

NIQUEL ESCOVADO NIQUEL PULIDO BRUSHED NICKEL

Barra de techo 15cm  
Ceilling rod 15cm

5069724x

X = 2

X = 3

X = 0

30 €

46 €

46 €

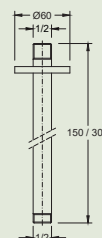



CROMADO CROMO CHROME	PRETO MATE NEGRO MATE BLACK MATT	NIQUEL ESCOVADO NIQUEL PULIDO BRUSHED NICKEL	REF	
X = 2	X = 3	X = 0		<b>CHUVEIRO DE MÃO (8L/MIN.)</b> Ducha de mano (8 L/min.) Hand shower (8 L/min.)
22 €	55 €	55 €	5069706x	
X = 2				<b>CHUVEIRO DE TECTO 20CM REDONDO EM ABS (8 L/MIN.)</b> Ducha de techo 20cm ABS (8 L/min.) ABS head shower 20cm (8 L/min.)
36 €			5068308x	
X = 2	X = 3	X = 0		<b>CHUVEIRO DE TECTO 20CM REDONDO EM LATÃO (8L/MIN.)</b> Ducha de techo en laton 20cm redondo (8 L/min.) Brass head shower 20cm (8 L/min.)
119 €	159 €	159 €	5068311x	
X = 2	X = 3	X = 0		<b>FLEXÍVEL DUPLA GRAFATURA 150CM</b> Manguera de ducha de mano 150cm Shower flexible hose 150cm
14 €	22 €	22 €	5061702x	
X = 2	X = 3	X = 0		<b>FLEXÍVEL PVC ANTI-TORSÃO 150CM</b> Manguera de ducha PVC anti-torsión 150cm PVC anti-torsion shower flexible hose 150cm
18 €	26 €	26 €	5061704x	
X = 2	X = 3	X = 0		<b>BICA DE BANHEIRA ENCASTRÁVEL 1/2"</b> Bica de bañera empotrable Wall-mounted bath spout
56 €	83 €	83 €	5062555x	
X = 2	X = 3	X = 0		<b>SIFÃO CILÍNDRICO</b> Sifón cilíndrico Cilindric siphon
52 €	74 €	74 €	5510913x	
X = 2	X = 3	X = 0		<b>VÁLVULA CLIC-CLAC</b> Válvula clic-clac Pop-up waste
20 €	28 €	28 €	55110022	



**TORNEIRA DE LAVATÓRIO 220V**

REF

CROMADO  
CROMO  
CHROME

Grifo para lavabo 220V  
Washbasin tap 220V

X = 2

5060202x

248 €

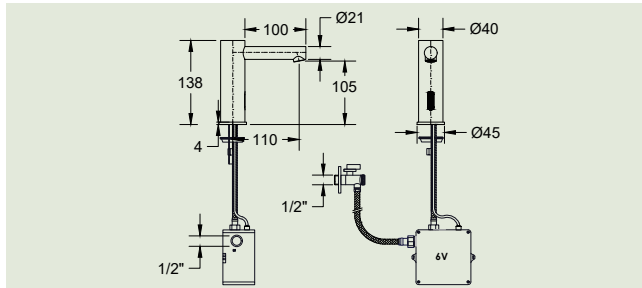

**TORNEIRA DE LAVATÓRIO ALTO 220V**

REF

CROMADO  
CROMO  
CHROME

Grifo para lavabo alto 220V  
Bowl tap 220V

X = 2

5060203x

297 €

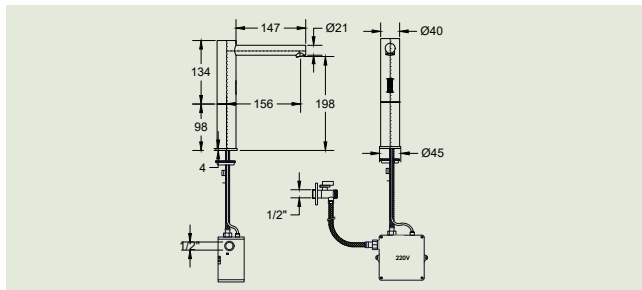

**TORNEIRA DE LAVATÓRIO MURAL 220V**

REF

CROMADO  
CROMO  
CHROME

Grifo para lavabo de pared 220V  
Wall-mounted washbasin tap 220V

X = 2

5060204x

279 €

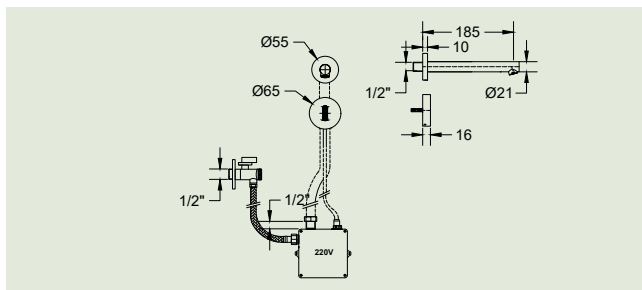

**TORNEIRA URINOL EXTERIOR 6V**

REF

CROMADO  
CROMO  
CHROME

Grifo para urinário exterior 6V  
Urinal faucet 6V

X = 2

5060205x

418 €

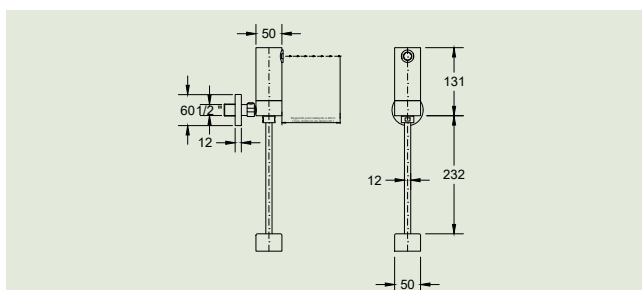

CROMADO  
CROMO  
CHROME

REF

## TORNEIRA URINOL MURAL 220V

X = 2

337 €

5060206x

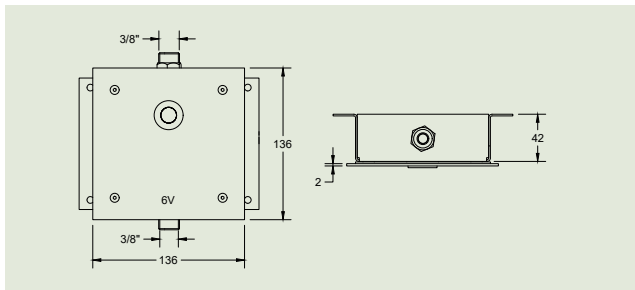
Grifo para urinário de parede 220V  
Wall-mounted urinal faucet 220VCROMADO  
CROMO  
CHROME

REF

## KIT DE PRÉ-MISTURA P/TORNEIRAS DE LAVATÓRIO

X = 2

37 €

5060207x

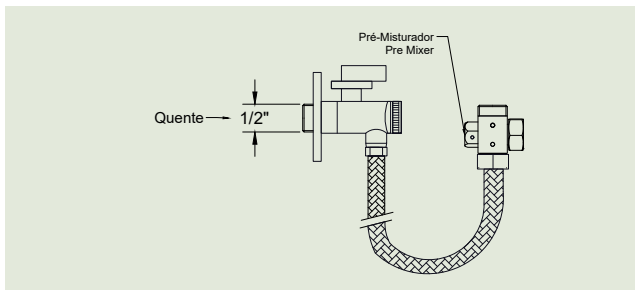
Kit de pmezcla para grifería de lavabo  
Pre-mix kit for washbasin taps

MISTURADORA DE LAVATÓRIO

REF

CROMADO  
CROMO  
CHROME

Mezcladora de lavabo  
Washbasin mixer

5068202x

X = 2

149 €

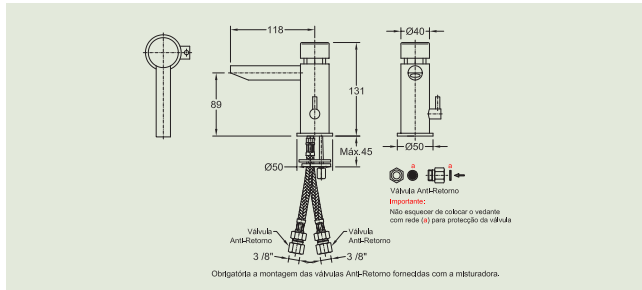

TORNEIRA DE LAVATÓRIO

REF

CROMADO  
CROMO  
CHROME

Grifo de lavabo  
Washbasin tap

5066711x

X = 2

86 €

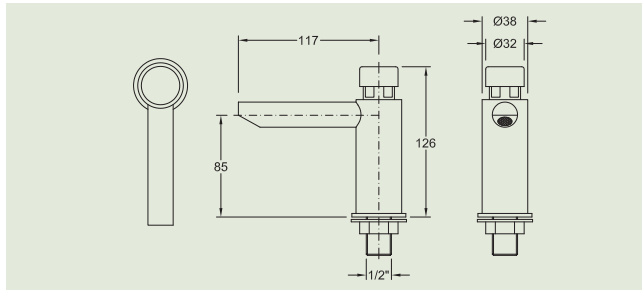

MONOCOMANDO DE LAVATÓRIO

REF

CROMADO  
CROMO  
CHROME

Monocomando de lavabo  
Single lever basin mixer

5060951x

X = 2

240 €

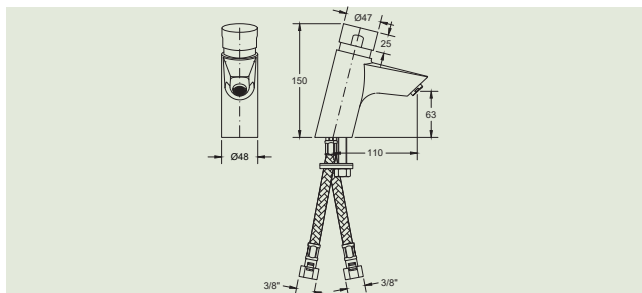

TORNEIRA DE LAVATÓRIO ECO

REF

CROMADO  
CROMO  
CHROME

Grifo de lavabo ECO  
Washbasin tap ECO

5060901x

X = 2

60 €

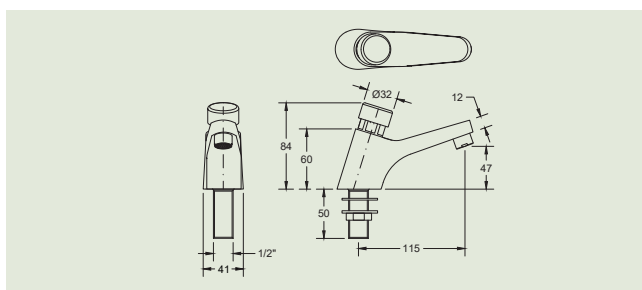

CROMADO  
CROMO  
CHROME

**REF TORNEIRA MURAL DE LAVATÓRIO ECO**

X = 2

72 €

5060961x

Grifo mural de lavabo ECO  
Wall-mounted washbasin tap ECO

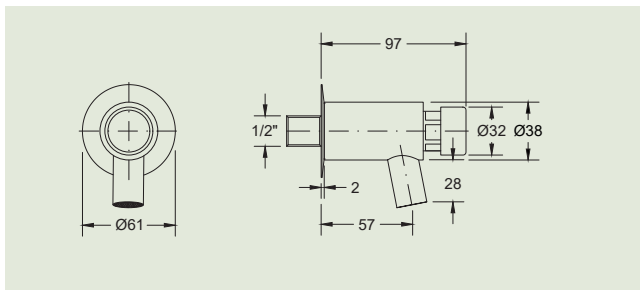

CROMADO  
CROMO  
CHROME

**REF TORNEIRA MURAL DE LAVATÓRIO**

X = 2

125 €

5060971x

Grifo mural de lavabo  
Wall-mounted washbasin tap

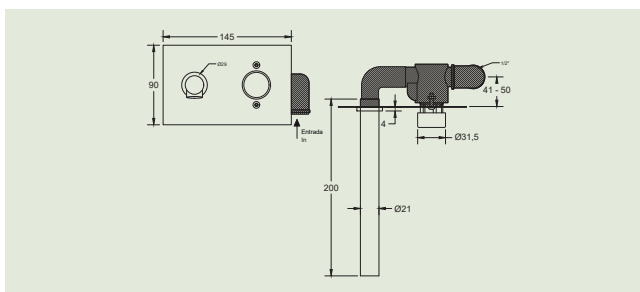

CROMADO  
CROMO  
CHROME

**REF TORNEIRA MURAL DE DUCHE ANTI FURTO**

X = 2

52 €

5060907x

Grifo mural de ducha antihurto  
Wall-mounted shower anti-theft

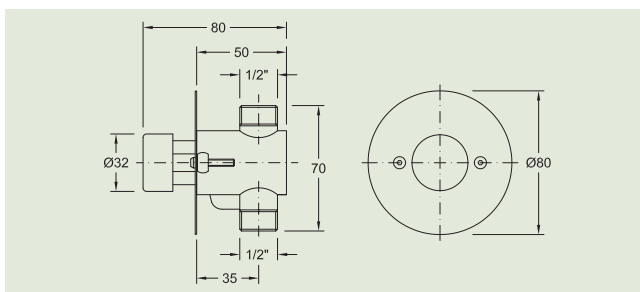

CROMADO  
CROMO  
CHROME

**REF MISTURADORA DE DUCHE DE ENCASTRAR**

X = 2

210 €

5066709x

Mezclador de ducha empotrado  
Wall-mounted shower mixer

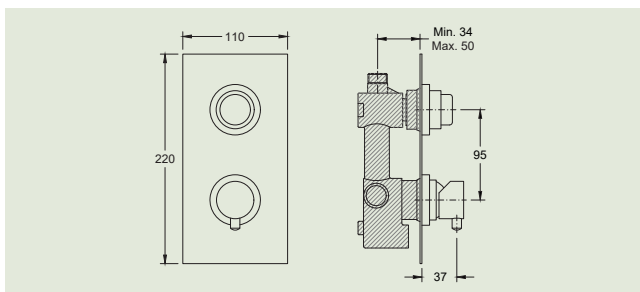

**MONOCOMANDO MURAL DE DUCHE**

REF

CROMADO  
CROMO  
CHROME

Monocomando mural de ducha  
Wall-mounted single lever shower  
mixer

5060917x

X = 2

318 €

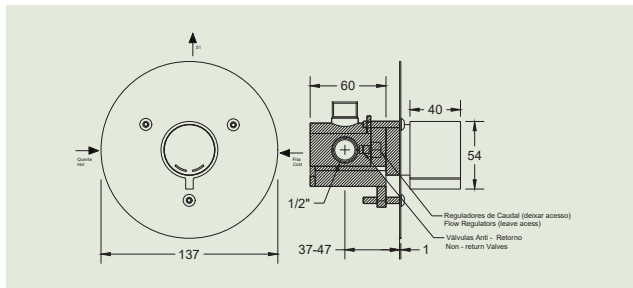

**CHUVEIRO À PAREDE  
ANTI-VANDALISMO**

REF

CROMADO  
CROMO  
CHROME

Ducha de pared antivandalismo  
Wall-mounted antivandalism shower

5060900x

X = 2

72 €

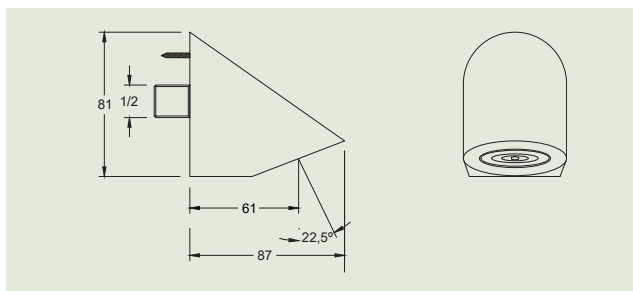

**TORNEIRA DE ESQUADRIA DE  
URINOL C/KIT DE DESCARGA**

REF

CROMADO  
CROMO  
CHROME

Grifo de urinário exterior  
c/kit de descarga  
External tap for urinal w/ flush kit

5060939x

X = 2

46 €

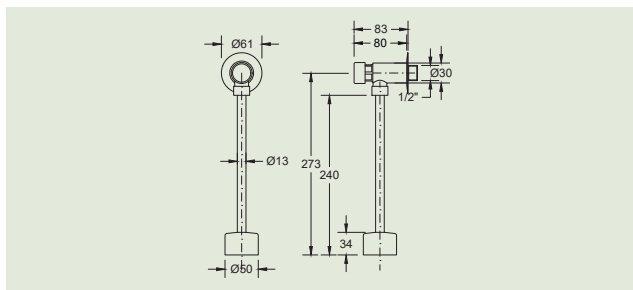

**TORNEIRA MURAL DE URINOL**

REF

CROMADO  
CROMO  
CHROME

Grifo de urinário mural  
Wall-mounted urinal tap

5060919x

X = 2

52 €

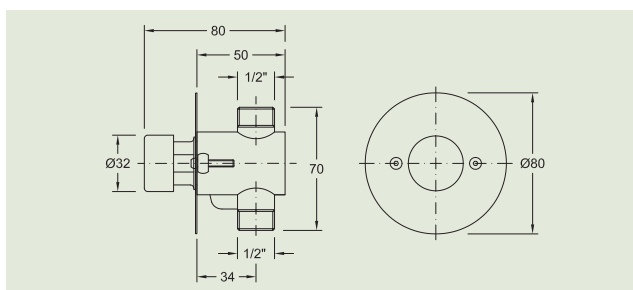

CROMADO  
CROMO  
CHROME

REF

**FLUXÓMETRO DE URINOL  
EXTERIOR C/ REGULAÇÃO DE CAUDAL**

X = 2

92 €

5060929x

Fluxor exterior para urinario con  
regulación de flujo  
Urinal flowmeter with flow regulation

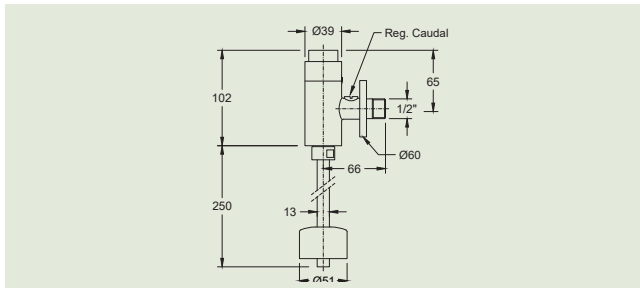

CROMADO  
CROMO  
CHROME

REF

**FLUXÓMETRO DE SANITA DE  
ENCASTRAR**

X = 2

82 €

5060918x

Fluxor mural para inodoro  
Wall-mounted WC flowmeter

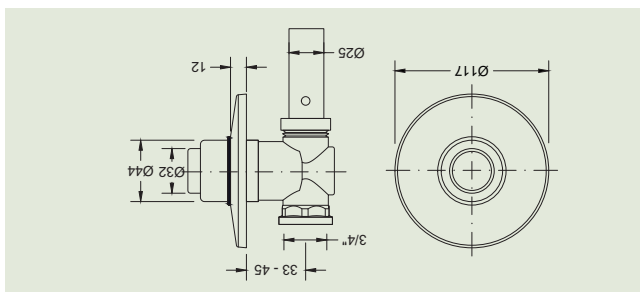

CROMADO  
CROMO  
CHROME

REF

**TUBO DE DESCARGA PARA  
FLUXÓMETRO DE SANITA  
DE ENCASTRAR**

X = 2

44 €

5506701x

Tubo de descarga para fluxor  
de inodoro mural  
Discharge tube for wall-mounted  
WC flowmeter

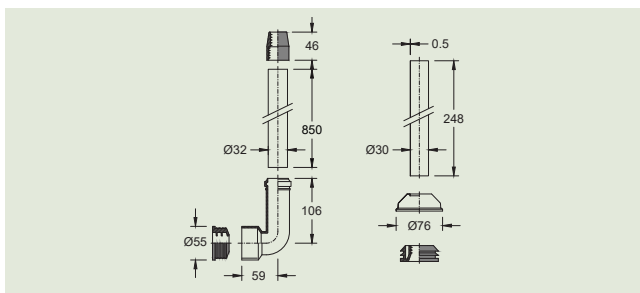

CROMADO  
CROMO  
CHROME

REF

**FLUXÓMETRO DE SANITA  
EXTERIOR**

X = 2

97 €

5060908x

Fluxor de inodoro exterior  
External WC flowmeter

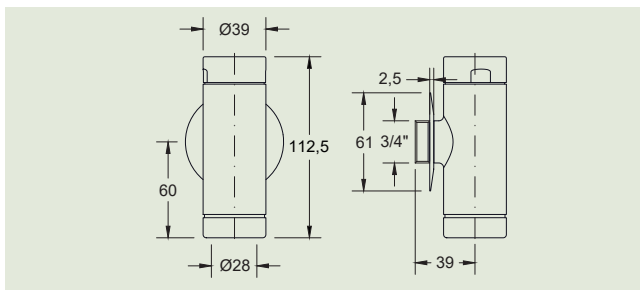

**FLUXÓMETRO DE SANITA EXTERIOR C/ REGULAÇÃO DE CAUDAL**

REF

CROMADO  
CROMO  
CHROME

X = 2

Fluxor de inodoro exterior con regulación de flujo  
External WC flowmeter with flow regulation

5060928x

115 €

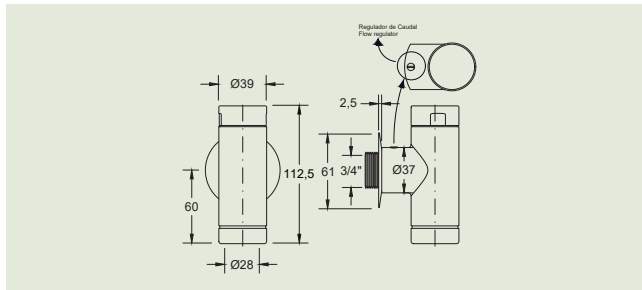

**TUBO DE DESCARGA PARA FLUXÓMETRO DE SANITA**

REF

CROMADO  
CROMO  
CHROME

X = 2

Tubo de descarga para fluxor de inodoro exterior  
Discharge tube for external WC flowmeter

5060910x

37 €



CROMADO  
CROMO  
CHROME

PRETO MATE  
NEGRO MATE  
BLACK MATE

NIQUEL ESCOVADO  
NIQUEL PULIDO  
BRUSHED NICKEL

REF

**MISTURADORA DUCHE C/ COLUNA  
TELESCÓPICA E CHUVEIRO DIÂM. 20CM**

X = 2

X = 3

X = 0

440 €

748 €

748 €

5068031x

Mezclador ducha c/ columna telescópico y ducha diam. 20cm  
Shower mixer with telescopic column and shower diam. 20cm

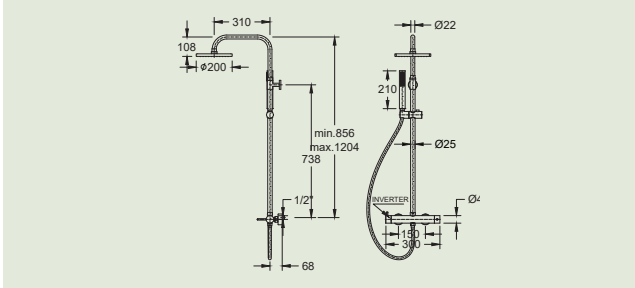

CROMADO  
CROMO  
CHROME

PRETO MATE  
NEGRO MATE  
BLACK MATE

NIQUEL ESCOVADO  
NIQUEL PULIDO  
BRUSHED NICKEL

REF

**MISTURADORA DUCHE C/ COLUNA  
TELESCÓPICA E CHUVEIRO DIÂM. 30CM**

X = 2

X = 3

X = 0

523 €

888 €

888 €

5068051x

Mezclador ducha c/ columna telescópico y ducha diam. 30cm  
Shower mixer with telescopic column and shower diam. 30cm

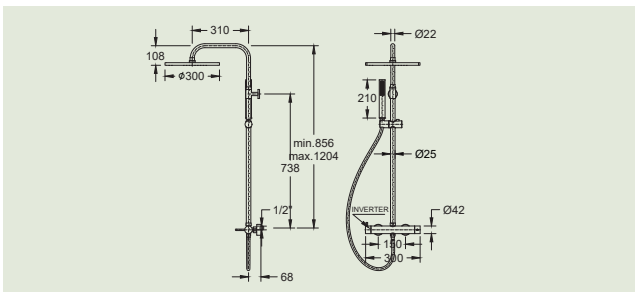

CROMADO  
CROMO  
CHROME

PRETO MATE  
NEGRO MATE  
BLACK MATE

NIQUEL ESCOVADO  
NIQUEL PULIDO  
BRUSHED NICKEL

REF

**MISTURADORA DUCHE TERMOSTÁTICA  
C/ COLUNA TELESCÓPICA E  
CHUVEIRO DIÂM. 20CM**

X = 2

X = 3

X = 0

450 €

766 €

766 €

5068032x

Mezclador ducha termostático c/ columna telescópico y ducha diam. 20cm  
Thermostatic shower mixer w/ telescopic column and shower diam. 20cm

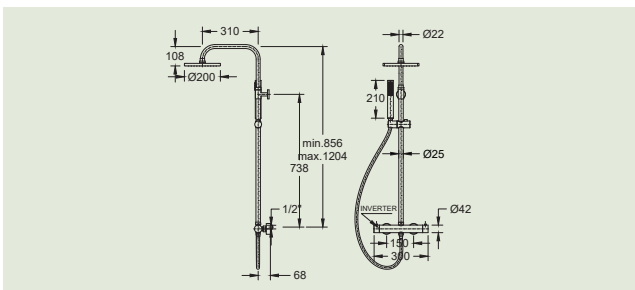

**MISTURADORA DUCHE TERMOSTÁTICA C/ COLUNA TELESCÓPICA E CHUVEIRO DIÂM. 30CM**

REF

CROMADO CROMO CHROME

PRETO MATE NEGRO MATE BLACK MATE

NIQUEL ESCOVADO NIQUEL PULIDO BRUSHED NICKEL

X = 2

X = 3

X = 0

Mezclador ducha termostático c/ columna telescópico y ducha diam. 30cm  
Thermostatic shower mixer with telescopic column and shower diam. 30cm

5068082x

586 €

998 €

998 €

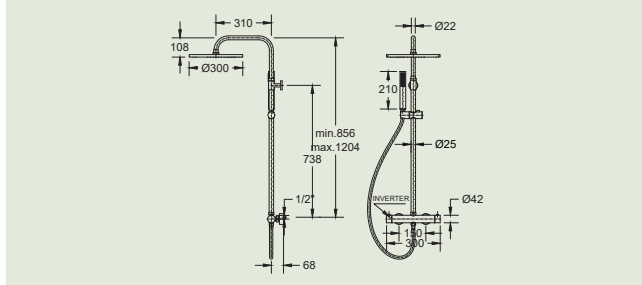

**MISTURADORA DUCHE C/ COLUNA TELESCÓPICA E CHUVEIRO 20x20CM**

REF

CROMADO CROMO CHROME

PRETO MATE NEGRO MATE BLACK MATE

NIQUEL ESCOVADO NIQUEL PULIDO BRUSHED NICKEL

X = 2

X = 3

X = 0

Mezclador ducha c/ columna telescópico y ducha 20x20cm  
Shower mixer with telescopic column and shower 20x20cm

5068061x

516 €

876 €

876 €

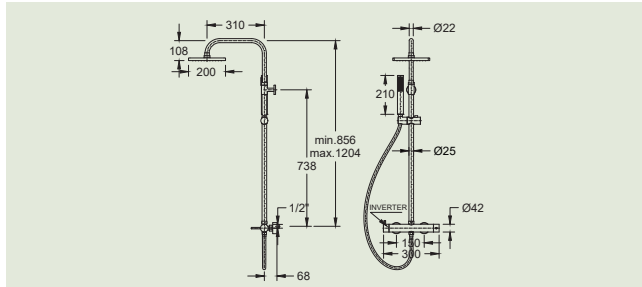

**MISTURADORA DUCHE C/ COLUNA TELESCÓPICA E CHUVEIRO 30x30CM**

REF

CROMADO CROMO CHROME

PRETO MATE NEGRO MATE BLACK MATE

NIQUEL ESCOVADO NIQUEL PULIDO BRUSHED NICKEL

X = 2

X = 3

X = 0

Mezclador ducha c/ columna telescópico y ducha 30x30cm  
Shower mixer with telescopic column and shower 30x30cm

5068071x

588 €

999 €

999 €

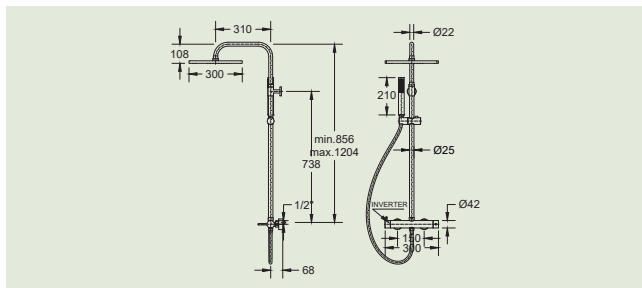

CROMADO  
CROMO  
CHROME

PRETO MATE  
NEGRO MATE  
BLACK MATE

NIQUEL ESCOVADO  
NIQUEL PULIDO  
BRUSHED NICKEL

REF

**MISTURADORA DUCHE  
TERMOSTÁTICA C/ COLUNA  
TELESCÓPICA E CHUVEIRO 20x20CM**

X = 2

X = 3

X = 0

525 €

893 €

893 €

5068062x

Mezclador ducha termostático c/ columna telescópico y ducha 20x20cm  
Thermostatic shower mixer with telescopic column and shower 20x20cm

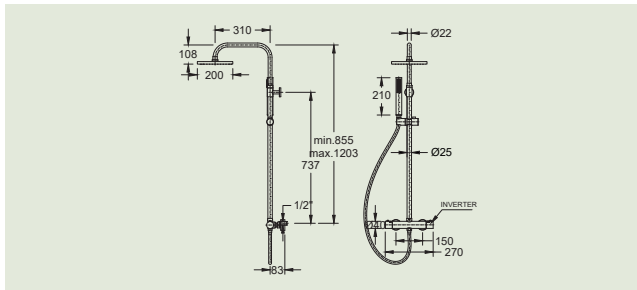

CROMADO  
CROMO  
CHROME

PRETO MATE  
NEGRO MATE  
BLACK MATE

NIQUEL ESCOVADO  
NIQUEL PULIDO  
BRUSHED NICKEL

REF

**MISTURADORA DUCHE  
TERMOSTÁTICA C/ COLUNA  
TELESCÓPICA E CHUVEIRO 30x30CM**

X = 2

X = 3

X = 0

598 €

1.016 €

1.016 €

5068092x

Mezclador ducha termostático c/ columna telescópico y ducha 30x30cm  
Thermostatic shower mixer with telescopic column and shower 30x30cm

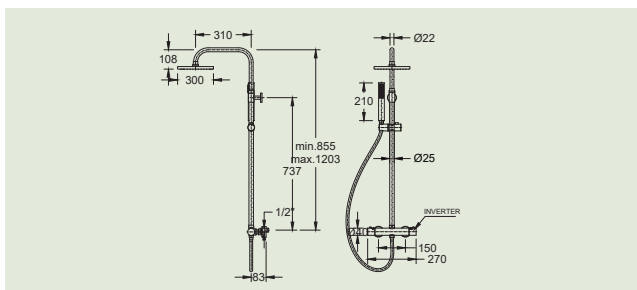

**CHUVEIRO DIÂM. 20 CM ABS (10 L/MIN)**

REF

CROMADO  
CROMO  
CRHOME

Ducha diam. 20 cm ABS (10 l/min)  
ABS shower diam. 20cm (10 l/min)

X = 2

5068308x

36 €

**CHUVEIRO DIÂM. 20 CM LATÃO (10 L/MIN)**

REF

CROMADO  
CROMO  
CRHOME

PRETO MATE  
NEGRO MATE  
BLACK MATE

NIQUEL ESCOAVADO  
NIQUEL PULIDO  
BRUSHED NICKEL

Ducha diam. 20 cm laton (10 l/min)  
Brass shower diam. 20cm (10 l/min)

X = 2

X = 3

X = 0

5068311x

119 €

159 €

159 €

**CHUVEIRO DIÂM. 30 CM ABS (10 L/MIN)**

REF

CROMADO  
CROMO  
CRHOME

Ducha diam. 30 cm ABS (10 l/min)  
ABS shower diam. 30 cm Cairo (10 l/min)

X = 2

5068310x

119 €

**CHUVEIRO DIÂM. 30 CM LATÃO (10 L/MIN)**

REF

CROMADO  
CROMO  
CRHOME

PRETO MATE  
NEGRO MATE  
BLACK MATE

NIQUEL ESCOAVADO  
NIQUEL PULIDO  
BRUSHED NICKEL

Ducha diam. 30 cm laton (10 l/min)  
Brass shower diam. 30 cm (10 l/min)

X = 2

X = 3

X = 0

5068312x

339 €

406 €

406 €

**CHUVEIRO 20x20 CM ABS (10 L/MIN)**

REF

CROMADO  
CROMO  
CRHOME

Ducha 20x20 cm ABS (10 l/min)  
ABS shower 20x20 cm (10 l/min)

X = 2

5068304x

59 €

**CHUVEIRO 20x20 CM EM LATÃO (10 L/MIN)**

REF

CROMADO  
CROMO  
CRHOME

PRETO MATE  
NEGRO MATE  
BLACK MATE

NIQUEL ESCOAVADO  
NIQUEL PULIDO  
BRUSHED NICKEL

Ducha 20x20 cm laton (10 l/min)  
Brass shower 20x20 cm (10 l/min)

X = 2

X = 3

X = 0

5068313x

152 €

182 €

182 €

**CHUVEIRO 30x30 CM EM ABS (10 L/MIN)**

REF

CROMADO  
CROMO  
CRHOME

Ducha 30x30 cm ABS (10 l/min) ABS  
shower 30x30 cm (10 l/min)

X = 2

5068306x

168 €

**CHUVEIRO 30x30 CM EM LATÃO (10 L/MIN)**

REF

CROMADO  
CROMO  
CRHOME

PRETO MATE  
NEGRO MATE  
BLACK MATE

NIQUEL ESCOAVADO  
NIQUEL PULIDO  
BRUSHED NICKEL

Ducha 30x30 cm laton (10 l/min)  
Brass shower 30x30 cm (10 l/min)

X = 2

X = 3

X = 0

5068314x

360 €

432 €

432 €

**HASTE DE PAREDE 35 CM**

REF

CROMADO  
CROMO  
CRHOME

PRETO MATE  
NEGRO MATE  
BLACK MATE

NIQUEL ESCOAVADO  
NIQUEL PULIDO  
BRUSHED NICKEL

Barra mural para ducha com 35cm  
Wall rod 35cm

X = 2

X = 3

X = 0

5069723x

42 €

63 €

63 €

**HASTE VERTICAL 15 CM**

REF

CROMADO  
CROMO  
CRHOME

PRETO MATE  
NEGRO MATE  
BLACK MATE

NIQUEL ESCOAVADO  
NIQUEL PULIDO  
BRUSHED NICKEL

Barra de techo 15cm  
Ceilling rod 15cm

X = 2

X = 3

X = 0

5069724x

30 €

46 €

46 €

**HASTE VERTICAL 30 CM**

REF

CROMADO  
CROMO  
CRHOME

PRETO MATE  
NEGRO MATE  
BLACK MATE

NIQUEL ESCOAVADO  
NIQUEL PULIDO  
BRUSHED NICKEL

Barra de techo 30 cm  
Ceiling rod 30 cm

X = 2

X = 3

X = 0

5069726x

43 €

57 €

57 €

**RAMPA DE DUCHE CILÍNDRICA ABS**

REF

CROMADO  
CROMO  
CRHOME

Rampa de ducha cilíndrica ABS  
ABS cylindrical shower rail

X = 2

5069508x

53 €

CROMADO CROMO CRHOME	REF	<b>CHUVEIRO DE PAREDE C/ HASTE</b>
x = 2		Ducha de pared Wall-mounted showerhead with stem
107 €	5064900x	

CROMADO CROMO CRHOME	REF	<b>CHUVEIRO À PAREDE ANTI-VANDALISMO</b>
x = 2		Ducha de pared antivandalico Wall-mounted antivandalism shower
72 €	5060900x	

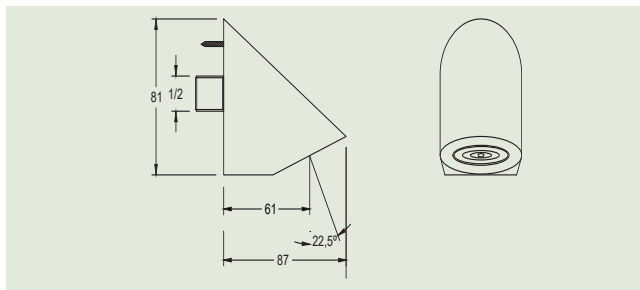

CROMADO CROMO CRHOME	PRETO MATE NEGRO MATE BLACK MATE	NIQUEL ESCOVADO NIQUEL PULIDO BRUSHED NICKEL	REF	<b>MISTURADORA SEMI-ENCASTRADA C/ KIT HIGIÉNICO</b>
x = 2	x = 3	x = 0		Mezclador semi-empotrado con kit de aseo Single lever semi-recessed mixer with hygienic kit
182 €	273 €	273 €	5069100x	

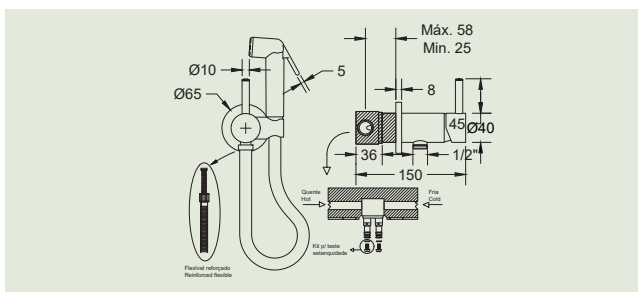

CROMADO CROMO CRHOME	REF	<b>CHUVEIRO DE MÃO CILÍNDRICO EM ABS</b>
x = 2		Ducha de mano cilíndrica em ABS ABS cilíndric hand shower
25 €	5069701X	

CROMADO CROMO CRHOME	PRETO MATE NEGRO MATE BLACK MATT	NIQUEL ESCOVADO NIQUEL PULIDO BRUSHED NICKEL	REF	<b>BICHA FLEXÍVEL DUPLA GRAFATURA 150 CM</b>
x = 2	x = 3	x = 0		Manguera de ducha de mano 150cm Shower flexible hose 150cm
14 €	22 €	22 €	5061702x	

CROMADO CROMO CRHOME	PRETO MATE NEGRO MATE BLACK MATE	NIQUEL ESCOVADO NIQUEL PULIDO BRUSHED NICKEL	REF	<b>MANGUERA DE DUCHA PVC ANTI-TORSIÓN 150CM</b>
x = 2	x = 3	x = 0		Manguera de ducha PVC anti-torsión 150cm PVC anti-torsion shower flexible hose 150cm
18 €	26 €	26 €	5061704x	

CROMADO CROMO CRHOME	PRETO MATE NEGRO MATE BLACK MATE	NIQUEL ESCOVADO NIQUEL PULIDO BRUSHED NICKEL	REF	<b>TOMADA DE ÁGUA C/ SUPORTE DE CHUVEIRO MANUAL</b>
x = 2	x = 3	x = 0		Conexión de agua con soporte de ducha de mano Water outlet w/ hand shower support
53 €	80 €	80 €	5517302x	





**TORNEIRA DE PASSAGEM 1/2"**

REF

CROMADO  
CROMO  
CRHOME

PRETO MATE  
NEGRO MATE  
BLACK MATE

NIQUEL ESCOVADO  
NIQUEL PULIDO  
BRUSHED NICKEL

Grifo de corte 1/2"  
Cutting tap 1/2"

5067902x

X = 2

X = 3

X = 0

20 €

28 €

28 €

**TORNEIRA DE PASSAGEM 3/4"**

REF

CROMADO  
CROMO  
CRHOME

PRETO MATE  
NEGRO MATE  
BLACK MATE

NIQUEL ESCOVADO  
NIQUEL PULIDO  
BRUSHED NICKEL

Grifo de corte 3/4"  
Cutting tap 3/4"

5067903x

X = 2

X = 3

X = 0

25 €

36 €

36 €

**TORNEIRA DE ESQUADRIA  
C/ FILTRO 1/2"x3/8"**

REF

CROMADO  
CROMO  
CRHOME

PRETO MATE  
NEGRO MATE  
BLACK MATE

NIQUEL ESCOVADO  
NIQUEL PULIDO  
BRUSHED NICKEL

Grifo de escuadra con filtro 1/2"x3/8"  
Angle tap w/ filter 1/2"x3/8"

5067904x

X = 2

X = 3

X = 0

14 €

21 €

21 €

**TORNEIRA DE ESQUADRIA C/  
FILTRO 1/2"x1/2"**

REF

CROMADO  
CROMO  
CRHOME

PRETO MATE  
NEGRO MATE  
BLACK MATE

NIQUEL ESCOVADO  
NIQUEL PULIDO  
BRUSHED NICKEL

Grifo de escuadra con filtro 1/2"x1/2"  
Angle tap w/ filter 1/2"x1/2"

5067905x

X = 2

X = 3

X = 0

18 €

25 €

25 €





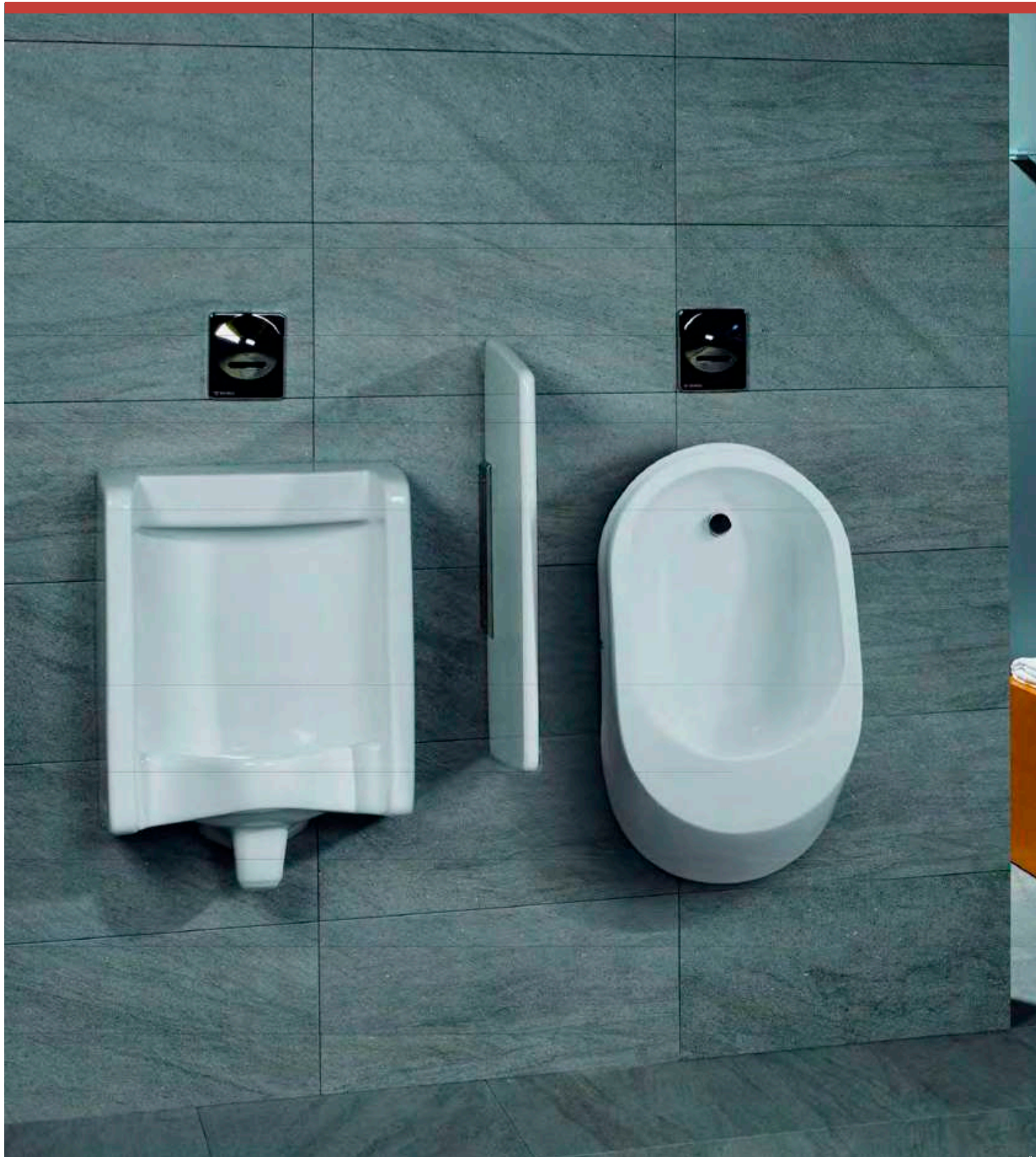



# ESPAÇOS PÚBLICOS

## ESPACIOS PÚBLICOS

### PUBLIC SPACES

<b>PMR</b>	182
<b>URINÓIS</b> URINARIOS URINALS	193
<b>JÚNIOR</b>	198
<b>INFANTIL</b> NIÑOS CHILDREN	201
<b>PEÇAS TÉCNICAS</b> PIEZAS TÉCNICAS TECHNICAL PIECES	202



PMR

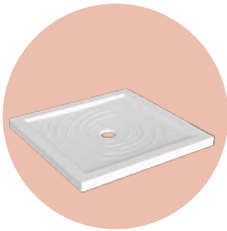

**BASE DE CHUVEIRO AQUA**  
PLATO DE DUCHA AQUA  
CERAMIC SHOWER TRAY AQUA  
PAG 185



**BACIA NORMAL**  
INODORO P/ TANQUE EMPOTRADO  
WC CONCEALED  
PAG 184



**BACIA SUSPensa**  
INODORO SUSPENDIDO  
WALL HUNG WC  
PAG 183

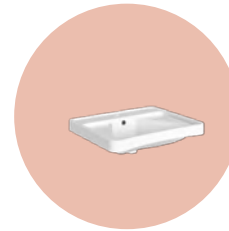

**LAVATÓRIO**  
LAVABO  
WASHBASIN  
PAG 182

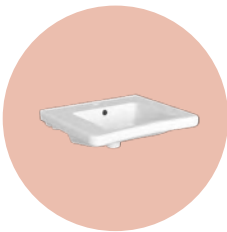

**LAVATÓRIO GAIA**  
LAVABO GAIA  
WASHBASIN GAIA  
PAG 182



**PMR TORNEIRAS**  
PMR GRIFOS  
PMR TAPS  
PAG 186

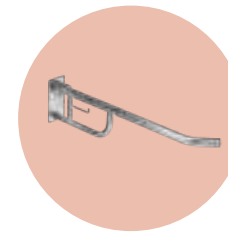

**PMR APOIOS**  
PMR APOYOS  
PMR ACCESSORIES  
PAG 187

ÚRINOIS | URINARIOS | URINALS



**EGG**  
PAG 193



**FACE**  
PAG 195



**FLÓRIDA**  
PAG 193

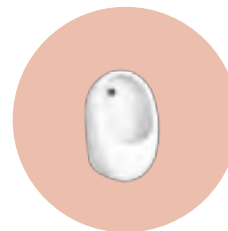

**KINO**  
PAG 195



**NIAGARA**  
PAG 194



**ORBITAL**  
PAG 193

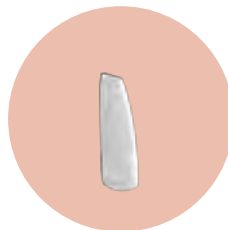

**SEPARADOR**  
SEPARATOR  
PAG 196

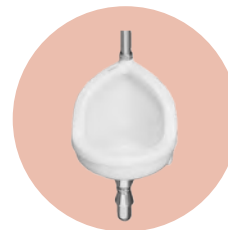

**CANTO**  
RINCÓN  
CORNER  
PAG 196

## JÚNIOR



**BACIA NORMAL**  
INODORO NORMAL  
WC CONCEALED  
PAG 198



**BACIA SUSPensa**  
INODORO SUSPENDIDO  
WALL-HUNG WC  
PAG 199



**LAVATÓRIO**  
LAVABO  
WASHBASIN  
PAG 198

## INFANTIL | NIÑOS | CHILDREN



**BACIA NORMAL**  
INODORO P/ TANQUE EMPOTRADO  
WC CONCEALED  
PAG 201



**LAVATÓRIO**  
LAVABO  
WASHBASIN  
PAG 201

## PEÇAS TÉCNICAS | PIEZAS TÉCNICAS | TECHNICAL PIECES

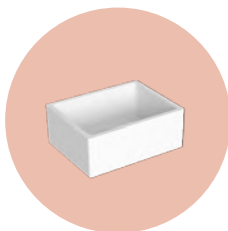

**PIA SINTRA**  
PILA SINTRA  
SINK SINTRA  
PAG 202

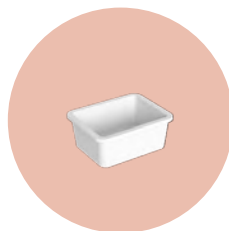

**PIA SILVES**  
PILA SILVES  
SINK SILVES  
PAG 202

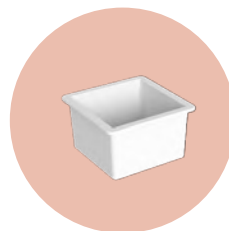

**PIA MONCHIQUE**  
PILA MONCHIQUE  
SINK MONCHIQUE  
PAG 202



**PIA DE DESPEJO**  
PILA DE DESCARGA  
DISCHARGE SINK  
PAG 202



**PIA HOSPITALAR**  
PILA VERTEDERO  
MEDICAL SLOP HOOPER  
PAG 203

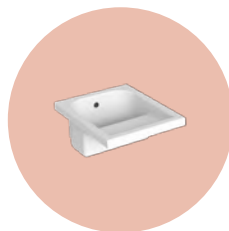

**LAVA-ROUPA MOZELA**  
LAVADERO MOZELA  
WASHER MOZELA  
PAG 203

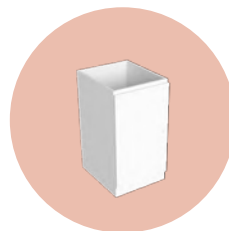

**MÓVEL LAVA-ROUPA MOZELA**  
MUEBLE LAVADERO MOZELA  
FURNITURE FOR MOZELA WASHER  
PAG 203



**LAVATÓRIO GAIA**

REF

BRANCO  
BLANCO  
WHITE

Lavabo Gaia  
Washbasin Gaia  
(62x55x20 cm)

78781xx2C

XX= 00

102 €

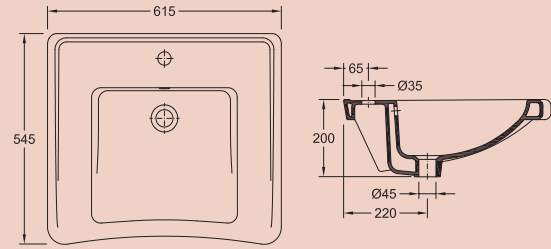

**LAVATÓRIO**

REF

BRANCO  
BLANCO  
WHITE

Lavabo  
Washbasin  
(67x57x24 cm)

78791xx2C

XX= 00

143 €

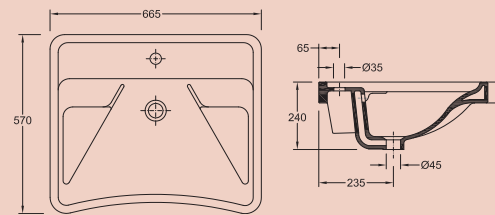

**SUPORTE BASCULANTE**

REF

AÇO INOX  
ACERO INOXIDABLE  
STAINLESS STEEL

Suporte basculante  
Washbasin lift support

55025000

416 €

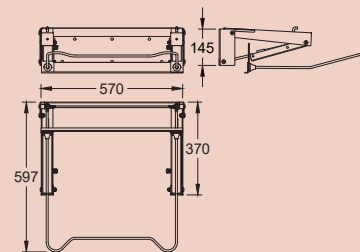

ACO INOX  
ACERO INOXIDABLE  
STAINLESS STEEL

REF

SUPOORTE REGULÁVEL

Soporte regulable  
Fixed support w/ pre-adjust

209 €

55089000

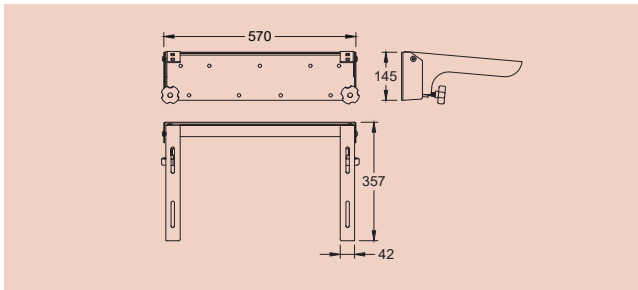

ACO INOX  
ACERO INOXIDABLE  
STAINLESS STEEL

REF

SUPOORTE FIJO

Soporte fijo  
Fixed support

114 €

55092000

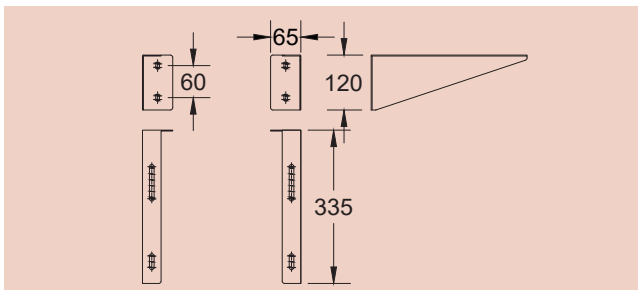

BRANCO  
BLANCO  
WHITE

REF

BACIA SUSPENSA PMR

Inodoro Suspendido PMR  
Wall-hung WC PMR  
(52x36x37 cm)

XX= 00

90 €

18003xx2K

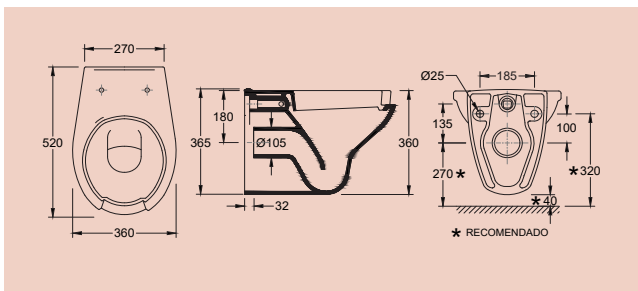

BRANCO  
BLANCO  
WHITE

REF

TAMPO CM

Tapa CM  
Toilet seat CM

XX= 00

87 €

50261xx0



**BACIA NORMAL V**

REF

BRANCO  
BLANCO  
WHITE

Inodoro p/ tanque empotrado V  
WC concealed V  
(56x36x45 cm)

18063xx2K

XX= 00

143 €

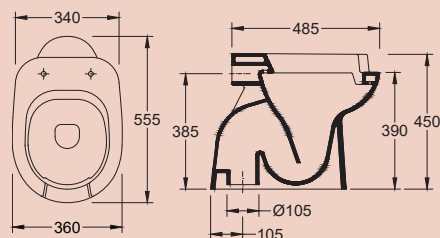
**TAMPO CM**

REF

BRANCO  
BLANCO  
WHITE

Tapa CM  
Toilet seat CM

50221xx0

XX= 00

87 €

**TANQUE CERÂMICO ENTRADA INFERIOR**

REF

BRANCO  
BLANCO  
WHITE

Tanque cerâmico entrada inferior  
Ceramic cistern bottom inlet

33182xx2

XX= 00

48 €

**MECANISMO DD DESCARGA ENTR. INFERIOR**

REF

BRANCO - CROMADO  
BLANCO - CROMO  
WHITE - CHROME

Mecanismo normal DD alimentación inferior  
Bottom inlet DD mechanism

55510041

61 €

**TANQUE PLÁSTICO EXTERIOR ENTRADA LATERAL COM MECANISMO**

REF

BRANCO - CROMADO  
BLANCO - CROMO  
WHITE - CHROME

Tanque plástico exterior entrada lateral, con mecanismo  
Side inlet external cistern, w/ mechanism

55118010

57 €

**TANQUE ENCASTRÁVEL DD INTRASLIM**

REF

BRANCO - CROMADO  
BLANCO - CROMO  
WHITE - CHROME

Tanque empotrado DD Intra slim  
Concealed cistern with DD mechanism  
Intra Slim  
(51x46x9 cm)

55037091

111 €

BRANCO  
BLANCO  
WHITE

REF

**BASE DE CHUVEIRO AQUA**

XX= 00

Plato de ducha Aqua  
Ceramic shower tray Aqua

220 €

78639xx2K

(90x90x5,5 cm)

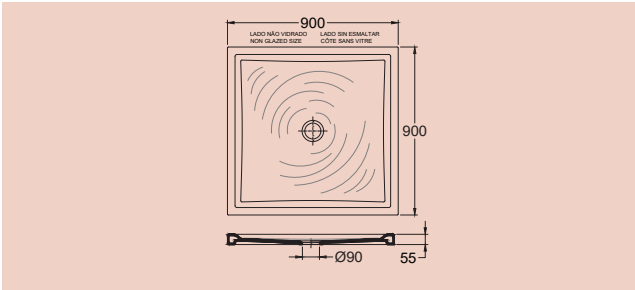

BRANCO - CROMADO  
BLANCO - CROMO  
WHITE - CHROME

REF

**KIT FIXAÇÃO N°3 (BACIA)**

5 €

55007003

Kit de fijación nº3 (inodoro)  
Fixing kit nº3 (WC)



BRANCO - CROMADO  
BLANCO - CROMO  
WHITE - CHROME

REF

**VÁLVULA DE DESCARGA DE DUCHE C/ SIFÃO**

37 €

55019010

Válvula de descarga de ducha com sifão  
Shower tray valve w/ siphon



**MISTURADORA TEMPORIZADA LAVATÓRIO**

CROMADO  
CROMO  
CHROME

REF

Grifo mezclador temporizado p/ lavabo  
Washbasin timer mixer

50682012

151 €

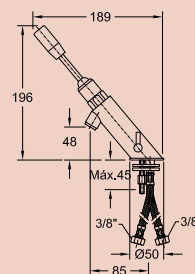

**TORNEIRA TEMPORIZADA LAVATÓRIO**

CROMADO  
CROMO  
CHROME

REF

Grifo temporizado p/ lavabo  
Washbasin timer tap

50667132

86 €

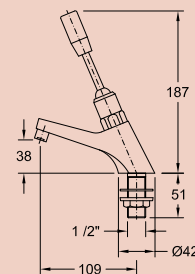

**MONOCOMANDO DE LAVATÓRIO STYLE**

CROMADO  
CROMO  
CHROME

REF

Monomando p/ lavabo Style  
Single lever washbasin mixer Style

50663022

119 €

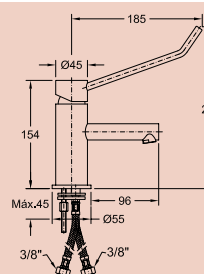



CROMADO  
CROMO  
CHROME

REF

**MONOCOMANDO DE  
BANHEIRA STYLE**

Monomando p/ banheira Style  
Single lever bath mixer Style

247 €

50663032

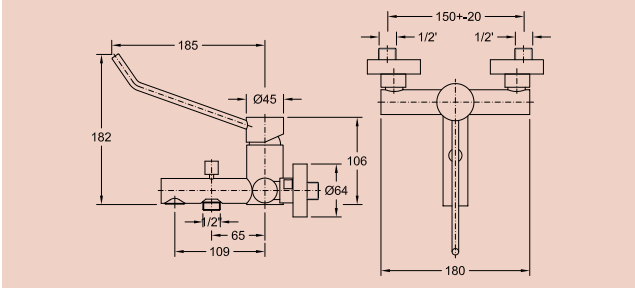

CROMADO  
CROMO  
CHROME

REF

**MONOCOMANDO DE BASE  
DE CHUVEIRO STYLE**

Monomando p/ ducha Style  
Single lever shower mixer Style

204 €

50663042

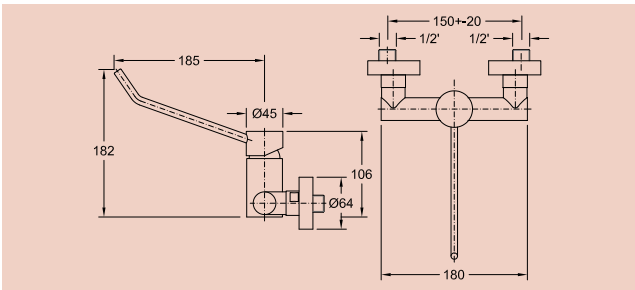

CROMADO  
CROMO  
CHROME

REF

**MONOCOMANDO DE LAVATÓRIO**

Monomando p/ lavabo  
Single lever washbasin mixer

78 €

50663000

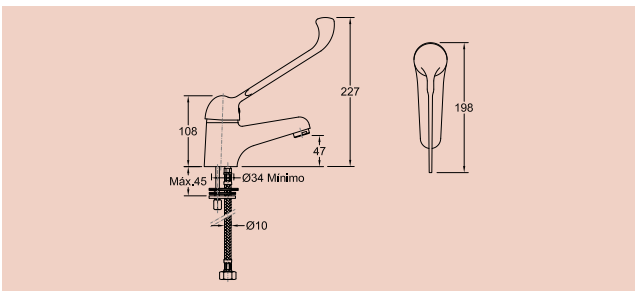

**MONOCOMANDO C/ CHUVEIRO DE VÁLVULA**

CROMADO  
CROMO  
CHROME

REF

Monomando p/ ducha c/pistola de presión  
Single lever shower mixer w/ valve shower

50680012

112 €

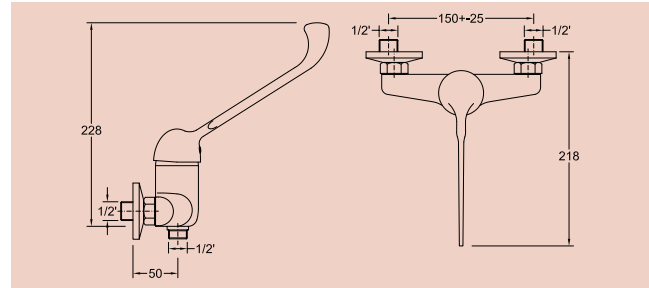

**MONOCOMANDO DE DUCHE**

CROMADO  
CROMO  
CHROME

REF

Monomando p/ducha  
Single lever shower mixer

50680022

102 €

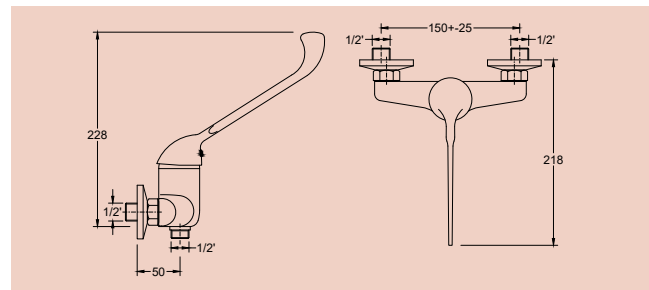

**ESPELHO BASCULANTE (40x73 CM)**

REF

Espejo basculante (40x73 cm)  
Adjustable mirror (40x73 cm)

XX=

0

8

3

INOX POLIDO  
ACERO INOXIDABLE PULIDO  
POLISHED STAINLESS STEEL

INOX ESCOVADO  
ACERO CEPILLADO  
BRUSHED STAINLESS STEEL

PRETO  
NEGRO  
BLACK

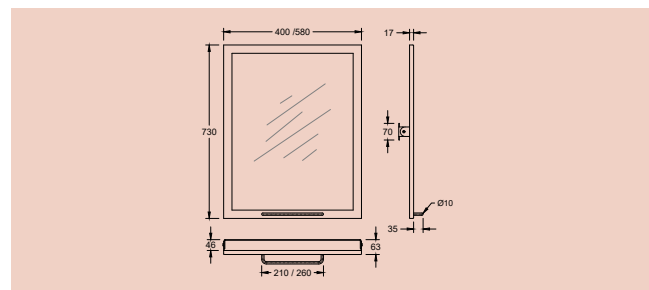

5098901x

289 €

289 €

434 €

**ESPELHO BASCULANTE (58x73 CM)**

Espejo basculante (58x73 cm)  
Adjustable mirror (58x73 cm)

5098902x

309 €

309 €

464 €

INOX POLIDO  
ACERO INOXIDABLE PULIDO  
POLISHED STAINLESS STEEL

INOX ESCOVADO  
ACERO CEPILLADO  
BRUSHED STAINLESS STEEL

PRETO  
NEGRO  
BLACK

REF

**BANCO DE CHUVEIRO REBATÍVEL C/  
ASSENTO EM NYLON (35x30 CM)**

XX= 0 8 3

270 €

270 €

405 €

5505901x

Asiento abatible de ducha en nylon  
(35x30 cm)  
Nylon folding shower seat (35x30 cm)

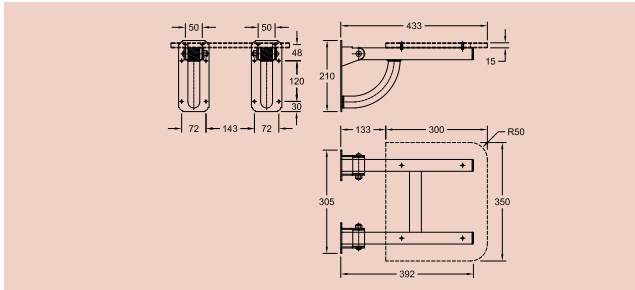

INOX POLIDO  
ACERO INOXIDABLE PULIDO  
POLISHED STAINLESS STEEL

INOX ESCOVADO  
ACERO CEPILLADO  
BRUSHED STAINLESS STEEL

PRETO  
NEGRO  
BLACK

REF

**BANCO DE CHUVEIRO REBATÍVEL  
C/ ASSENTO EM NYLON (70x40 CM)**

XX= 0 8 3

308 €

308 €

462 €

5505902x

Asiento abatible de ducha en nylon  
(70x40 cm)  
Nylon folding shower seat (70x40 cm)

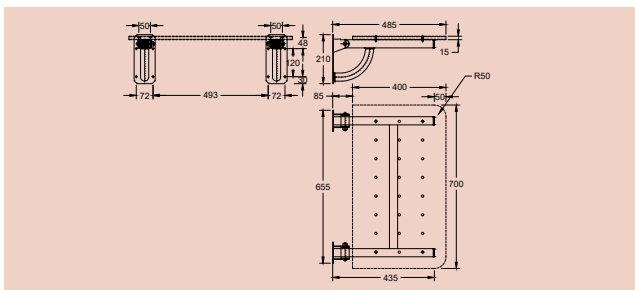

INOX POLIDO  
ACERO INOXIDABLE PULIDO  
POLISHED STAINLESS STEEL

INOX ESCOVADO  
ACERO CEPILLADO  
BRUSHED STAINLESS STEEL

PRETO  
NEGRO  
BLACK

REF

**APOIO DIREITO P/ SANITA**

XX= 0 8 3

178 €

178 €

267 €

5514009x

Apoyo derecho para inodoro  
WC support right

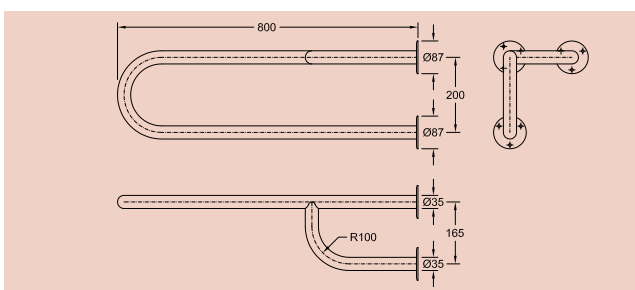

**APOIO ESQUERDO P/ SANITA**

178 €

178 €

267 €

5514010x

Apoyo izquierdo para inodoro  
WC support left



**APOIO BASCULANTE P/ SANITA C/  
PORTA ROLO DIREITO**

REF

XX=	INOX POLIDO ACERO INOXIDABLE PULIDO POLISHED STAINLESS STEEL	INOX ESCOVADO ACERO CEPILLADO BRUSHED STAINLESS STEEL	PRETO NEGRO BLACK
	0	8	3

Apoyo basculante p/ inodoro con portarrollos derecho  
Adjustable WC support right w/ paper holder

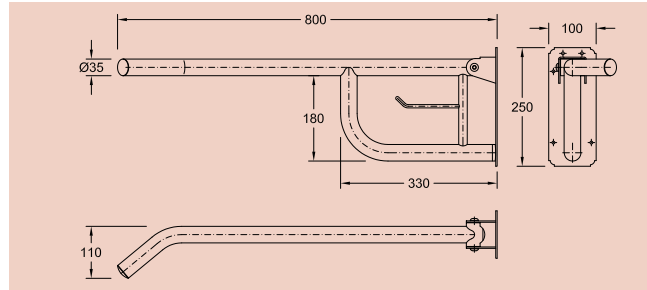

5514012x

207 €

207 €

311 €

**APOIO BASCULANTE P/ SANITA  
DIREITO**

Apoyo basculante p/ inodoro derecho  
Adjustable WC support right

5514002x

171 €

171 €

257 €

**APOIO BASCULANTE P/ SANITA C/  
PORTA ROLO ESQUERDO**

Apoyo basculante p/ inodoro con portarrollos izquierdo  
Adjustable WC support left w/ paper holder

5514013x

207 €

207 €

311 €

**APOIO BASCULANTE P/ SANITA  
ESQUERDO**

Apoyo basculante p/ inodoro izquierdo  
Adjustable WC support left

5514003x

171 €

171 €

257 €

**APOIO BASCULANTE P/ SANITA C/  
PORTA ROLO**

REF

XX=	INOX POLIDO ACERO INOXIDABLE PULIDO POLISHED STAINLESS STEEL	INOX ESCOVADO ACERO CEPILLADO BRUSHED STAINLESS STEEL	PRETO NEGRO BLACK
	0	8	3

Apoyo basculante p/ inodoro con portarrollos  
Adjustable WC support w/ paper holder

5514014x

220 €

220 €

330 €

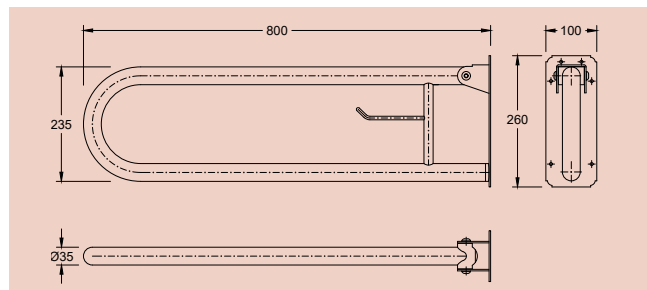

INOX POLIDO  
ACERO INOXIDABLE PULIDO  
POLISHED STAINLESS STEEL

INOX ESCOVADO  
ACERO CEPILLADO  
BRUSHED STAINLESS STEEL

PRETO  
NEGRO  
BLACK

REF

**PEDESTAL EXTERIOR DE  
FIXAÇÃO AO CHÃO**

XX= 0 8 3

Pedestal exterior para fijación al suelo  
External floor standing pedestal

322 € 322 € 483 €

5514030x

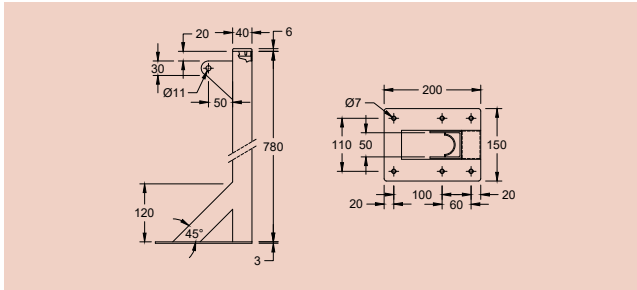

INOX POLIDO  
ACERO INOXIDABLE PULIDO  
POLISHED STAINLESS STEEL

INOX ESCOVADO  
ACERO CEPILLADO  
BRUSHED STAINLESS STEEL

PRETO  
NEGRO  
BLACK

REF

**APOIO ARTICULADO 80 CM**

XX= 0 8 3

Apoyo articulado 80cm  
Articulated support 80 cm

229 € 229 € 344 €

5514011x

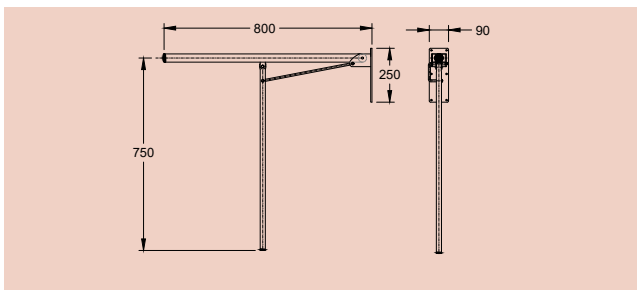

INOX POLIDO  
ACERO INOXIDABLE PULIDO  
POLISHED STAINLESS STEEL

INOX ESCOVADO  
ACERO CEPILLADO  
BRUSHED STAINLESS STEEL

PRETO  
NEGRO  
BLACK

REF

**APOIO DIREITO P/ LAVATÓRIO**

XX= 0 8 3

Apoyo derecho para lavabo  
Washbasin support right

125 € 125 € 188 €

5514007x

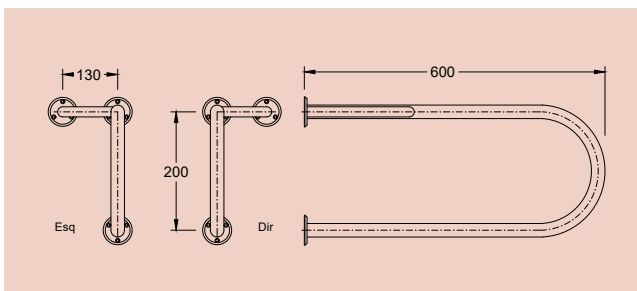

125 € 125 € 188 €

5514008x

**APOIO ESQUERDO P/ LAVATÓRIO**

Apoyo izquierdo para lavabo  
Washbasin support left



**APOIO AÇO INOX 400 MM**

Barra sencilla 400 mm  
Support w/ 400 mm



REF

XX=	INOX POLIDO ACERO INOXIDABLE PULIDO POLISHED STAINLESS STEEL	INOX ESCOVADO ACERO CEPILLADO BRUSHED STAINLESS STEEL	PRETO NEGRO BLACK
0	8	3	

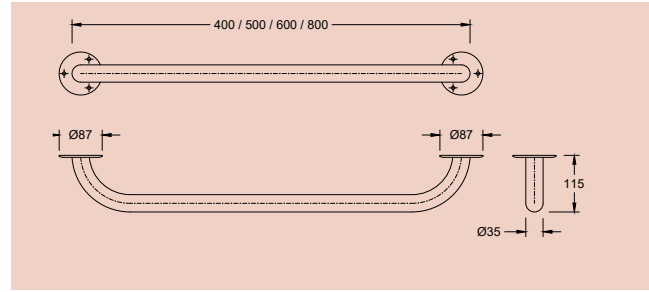

5514004x

75 €

75 €

113 €

**APOIO AÇO INOX 500 MM**

Barra sencilla 500 mm  
Support w/ 500 mm

5514005x

83 €

83 €

125 €

**APOIO AÇO INOX 600 MM**

Barra sencilla 600 mm  
Support w/ 600 mm

5514001x

88 €

88 €

132 €

**APOIO AÇO INOX 800 MM**

Barra sencilla 800 mm  
Support w/ 800 mm

5514006x

92 €

92 €

138 €

**APOIO DE CANTO 600x600 MM**

Apoyo angular 600x600 mm  
Horizontal corner support 600x600 mm



REF

XX=	INOX POLIDO ACERO INOXIDABLE PULIDO POLISHED STAINLESS STEEL	INOX ESCOVADO ACERO CEPILLADO BRUSHED STAINLESS STEEL	PRETO NEGRO BLACK
0	8	3	

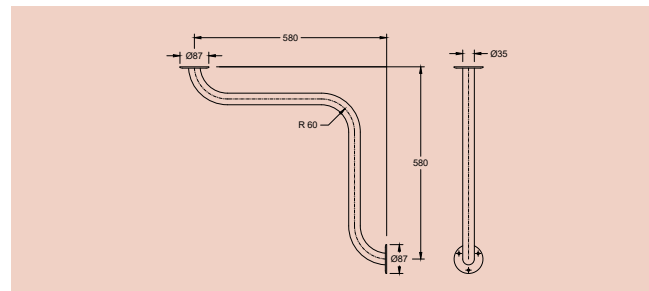

5514017x

121 €

121 €

182 €

**APOIO VERTICAL DE CANTO  
600x600 MM**

Apoyo vertical de rincon 600x600 mm  
Vertical corner support 600x600 mm

5514019x

129 €

129 €

194 €

BRANCO BLANCO WHITE      CORES STANDARD COLORES STANDARD STANDARD COLORS      REF      **FLÓRIDA (ALIM. TRAS.)**

XX= 00      23 / 47 / 48

Flórida (alim. tras.)  
Florida (back inlet)

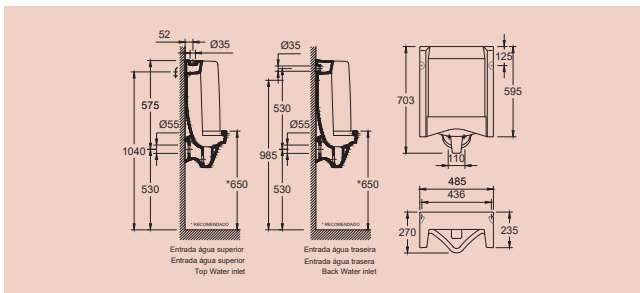

183 €      321 €

18511xx2K

(49x27x70 cm)

183 €      321 €

18510xx2K

**FLÓRIDA (ALIM. SUP.)**

Flórida (alim. sup.)  
Florida (top inlet)

(49x27x70 cm)

BRANCO BLANCO WHITE      CORES STANDARD COLORES STANDARD STANDARD COLORS      REF      **ORBITAL**

XX= 00      23 / 47 / 48

287 €      502 €

78560xx2K

(42x25x75 cm)

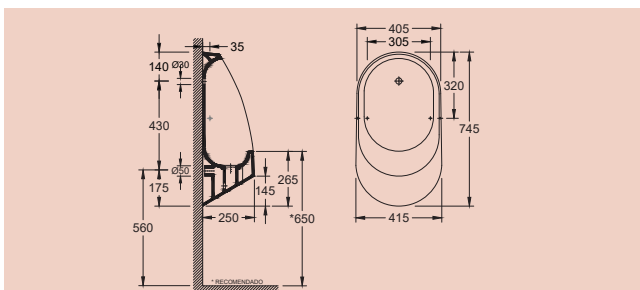

BRANCO BLANCO WHITE      CORES STANDARD COLORES STANDARD STANDARD COLORS      REF      **EGG**

XX= 00      23 / 47 / 48

199 €      349 €

39530xx2K

(34x31x66 cm)

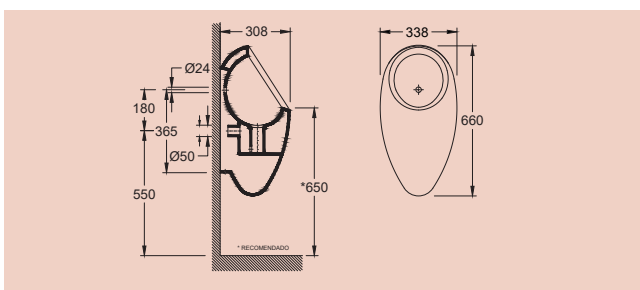

**NIAGARA (ALIM. TRAS.)**

REF

BRANCO  
BLANCO  
WHITE

CORES STANDARD  
COLORES STANDARD  
STANDARD COLORS

Niagara (alim. tras.)  
Niagara (back inlet)

XX= 00

23 / 47 / 48

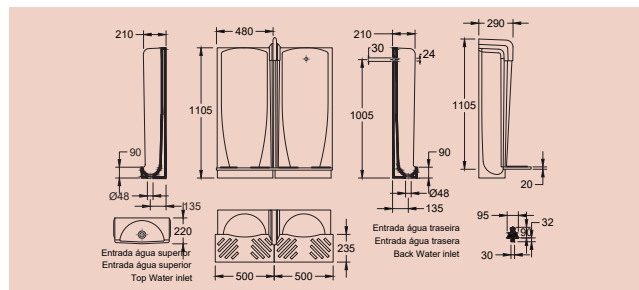

(48x22x110 cm)

18521xx2K

351 €

615 €

**NIAGARA (ALIM. SUP.)**

Niagara (alim. sup.)  
Niagara (top inlet)

(48x22x110 cm)

18520xx2K

351 €

615 €

**COBRE JUNTAS CURVO**

REF

BRANCO  
BLANCO  
WHITE

CORES STANDARD  
COLORES STANDARD  
STANDARD COLORS

Cubre juntas curvo  
Curve joint cover

XX= 00

23 / 47 / 48

18923xx2

43 €

75 €

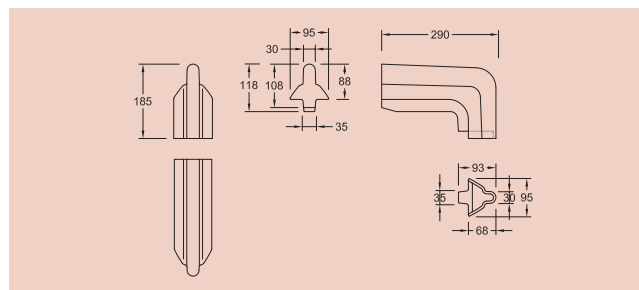

**COBRE JUNTAS RECTO**

REF

BRANCO  
BLANCO  
WHITE

CORES STANDARD  
COLORES STANDARD  
STANDARD COLORS

Cubre juntas recto  
Straight joint cover

XX= 00

23 / 47 / 48

18922xx2

45 €

80 €

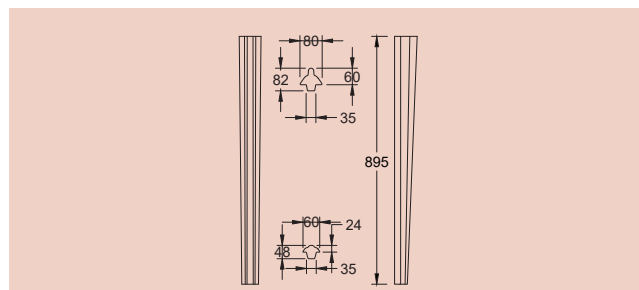



BRANCO BLANCO WHITE      CORES STANDARD COLORES STANDARD STANDARD COLORS      REF      **TERRAÇO URINOL**

XX= 00      23 / 47 / 48

Suelo p/ Urinario  
Urinal ceramic floor

55 €

96 €

18930xx2

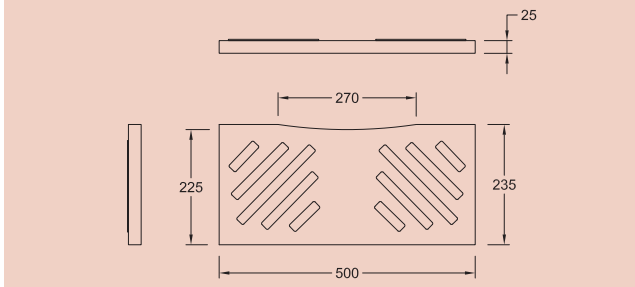

BRANCO BLANCO WHITE      CORES STANDARD COLORES STANDARD STANDARD COLORS      REF      **KINO**

XX= 00      23 / 47 / 48

(39x26x57 cm)

221 €

387 €

78530xx2K

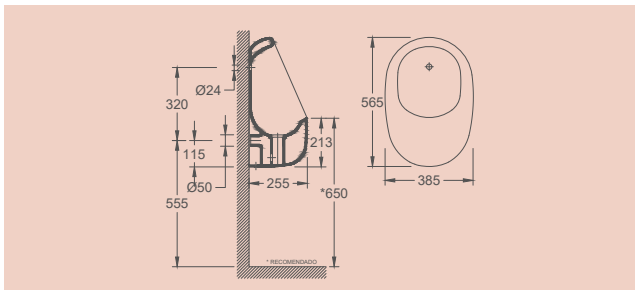

BRANCO BLANCO WHITE      CORES STANDARD COLORES STANDARD STANDARD COLORS      REF      **FACE (ALIM. TRAS.)**

XX= 00      23 / 47 / 48

Face (alim. tras.)  
Face (back inlet)

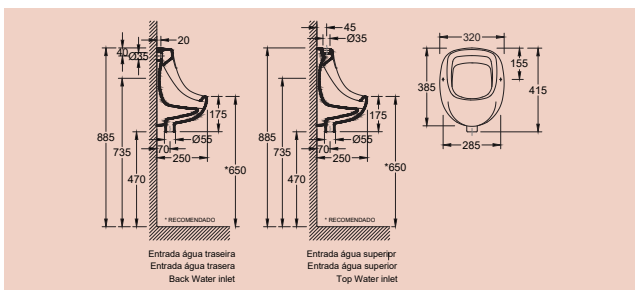

84 €

18541xx2K

(32x25x42 cm)

84 €

18540xx2K

**FACE (ALIM. TRAS.)**

Face (alim. tras.)  
Face (back inlet)

(32x25x42 cm)



**CANTO (ALIM. SUP.)**

REF

BRANCO  
BLANCO  
WHITE

Rincón (alim. sup.)  
Corner (top inlet)

XX= 00

18550xx2K

153 €

(32x31x41 cm)

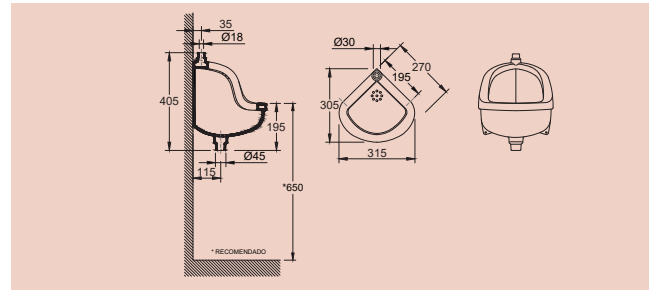

**SEPARADOR CERÂMICO**

REF

BRANCO  
BLANCO  
WHITE

CORES STANDARD  
COLORES STANDARD  
STANDARD COLORS

Separador cerâmico  
Ceramic separator

XX= 00

23 / 47 / 48









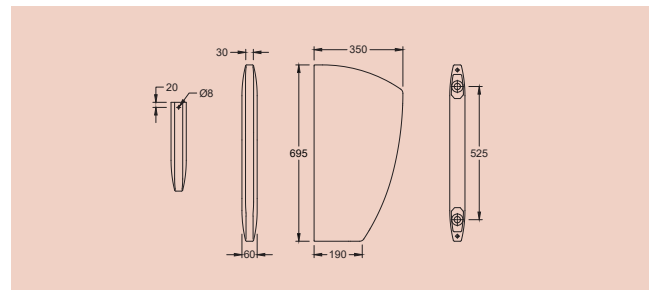

78924xx2K

188 €

329 €

(35x6x70 cm)



	<b>REF</b>	<b>KIT INSTALAÇÃO URINOL FLÓRIDA (ALIM. TRAS.)</b>	
41 €	55011020	Kit de instalación para urinario Florida (alim. tras.) Florida urinal installation kit (back inlet)	
	<b>REF</b>	<b>KIT INSTALAÇÃO URINOL FLÓRIDA (ALIM. SUP.)</b>	
41 €	55011000	Kit de instalación para urinario Florida (alim. sup.) Florida urinal installation kit (top inlet)	
	<b>REF</b>	<b>KIT INSTALAÇÃO URINOL ORBITAL</b>	
56 €	55041041	Kit de instalación para urinario Orbital Orbital urinal installation kit	
	<b>REF</b>	<b>KIT INSTALAÇÃO URINOL NIAGARA (ALIM. TRAS.)</b>	
43 €	55013001	Kit de instalación para urinario Niagara (alim. tras.) Niagara urinal installation kit (back inlet)	
	<b>REF</b>	<b>KIT INSTALAÇÃO URINOL NIAGARA (ALIM. SUP.)</b>	
43 €	55013011	Kit de instalación para urinario Niagara (alim. sup.) Niagara urinal installation kit (top inlet)	
	<b>REF</b>	<b>KIT INSTALAÇÃO URINÓIS EGG/KINO</b>	
56 €	55041061	Kit de instalación para urinarios Egg/ Kino Egg/Kino urinals installation kit	
	<b>REF</b>	<b>KIT INSTALAÇÃO URINOL FACE (ALIM. TRAS.)</b>	
53 €	55012010	Kit de instalación para urinario Face (alim. tras.) Face urinal installation kit (back inlet)	
	<b>REF</b>	<b>KIT INSTALAÇÃO URINOL FACE (ALIM. SUP.)</b>	
53 €	55012000	Kit de instalación para urinario Face (alim. sup.) Face urinal installation kit (top inlet)	
	<b>REF</b>	<b>KIT INSTALAÇÃO URINOL DE CANTO (ALIM. SUP.)</b>	
53 €	55032000	Kit de instalación para urinario de rincon (alim. sup.) Corner urinal installation kit (top inlet)	
	<b>REF</b>	<b>KIT INSTALAÇÃO SEPARADOR CERÂMICO</b>	
21 €	55150170	Kit de instalación de separador ceramico Ceramic separator installation kit	

**LAVATÓRIO**

Lavabo  
Washbasin  
(36x36x61 cm)



REF

BRANCO  
BLANCO  
WHITE

PRETO  
NEGRO  
BLACK

XX=

00

48

18601xx2C

190 €

333 €

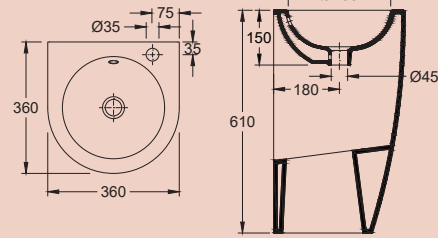

**BACIA NORMAL V**

Inodoro p/ tanque empotrado V  
WC Concealed V  
(39x28x29 cm)



REF

BRANCO  
BLANCO  
WHITE

PRETO  
NEGRO  
BLACK

XX=

00

48

18651xx2KV

153 €

268 €

**BACIA NORMAL H**

Inodoro p/ tanque empotrado H  
WC Concealed H  
(39x28x29 cm)

18651xx2KH

153 €

268 €

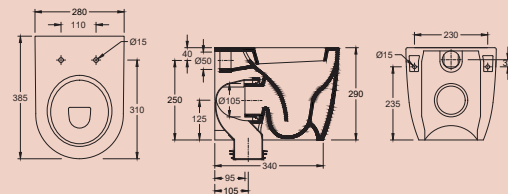

BRANCO BLANCO WHITE	PRETO NEGRO BLACK	REF	BACIA SUSPENSA
XX= 00	48		Inodoro suspenso Wall-hung WC (39x28x29 cm)
153 €	268 €	18651xx2KS	

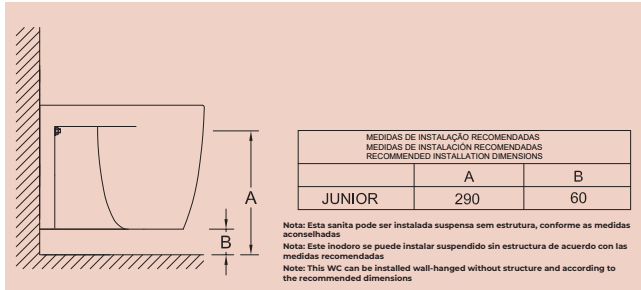

BRANCO BLANCO WHITE	CORES (TAMPOS) COLORES (TAPAS) COLORS (TOILET SEATS)	REF	TAMPO CM
XX= 00	51 / 52 / 53 / 54		Tapa CM Toilet seat CM
76 €	86 €	50259xx0	

Cores dos tampos | Colores de las tapas | Toilet seat colors

- 00 - branco | blanco | white
- 51 - amarelo | amarillo | yellow
- 52 - vermelho | rojo | red
- 53 - azul celeste | azul celeste | light blue
- 54 - rosa | rosa | pink





**KIT FIXAÇÃO**

REF

Kit de fijación  
Fixing kit

55007003

5 €

**KIT FIXAÇÃO (BACIA SUSPENSA)**

REF

Kit de fijación (inodoro suspendido)  
Fixing kit (wall-hung WC)

55007005

13 €

**CURVA DE DESCARGA VERTICAL**

REF

Curva de descarga vertical  
Vertical discharge curve

55104041

21 €

**TUBO DE DESCARGA  
HORIZONTAL 25CM**

REF

Tubo de descarga horizontal 25cm  
Horizontal discharge tube 25cm

55040010

21 €



BRANCO  
BLANCO  
WHITE

REF

LAVATÓRIO

XX= 00

Lavabo  
Washbasin

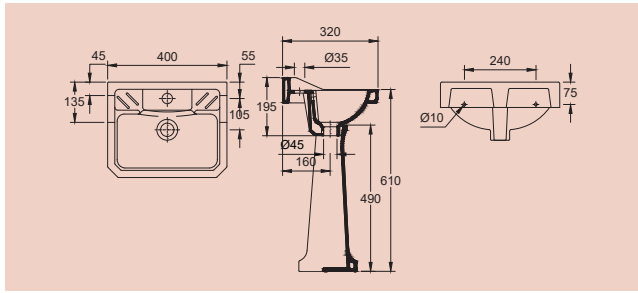

89 €

16371xx2C

(40x32x20 cm)

65 €

16230xx2K

**COLUNA**

Columna  
Pedestal

BRANCO  
BLANCO  
WHITE

REF

BACIA NORMAL V

XX= 00

Inodoro p/ tanque empotrado V  
WC concealed V

102 €

18650xx2K

(35x27x29 cm)

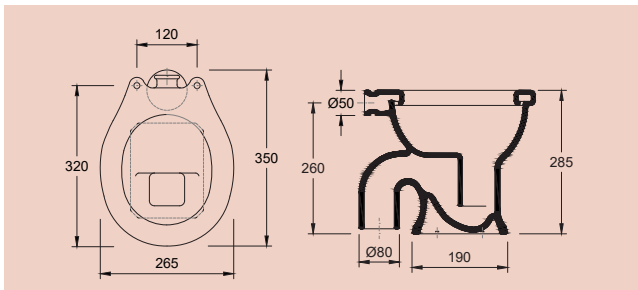

BRANCO  
BLANCO  
WHITE

CORES (TAMPOS)  
COLORES (TAPAS)  
COLORS (TOILET SEATS)

REF

TAMPO CM

XX= 00

51 / 52 / 53 / 54

Tapa CM  
Toilet seat CM

76 €

86 €

50308xx0

Cores dos tampos | Colores de las tapas | Toilet seat colors

- 00 - branco | blanco | white
- 51 - amarelo | amarillo | yellow
- 52 - vermelho | rojo | red
- 53 - azul celeste | azul celeste | light blue
- 54 - rosa | rosa | pink

REF

KIT FIXAÇÃO Nº3 (LAVATÓRIO E BACIAS)

5 €

55007003

Kit de fijación nº3 (lavabo y inodoros)  
Fixing kit nº3 (washbasin and WC)

**PIA SINTRA**

REF

BRANCO  
BLANCO  
WHITE

Pila Sintra  
Sink Sintra  
(48x38x19 cm)

78615xx2C

XX= 00

140 €

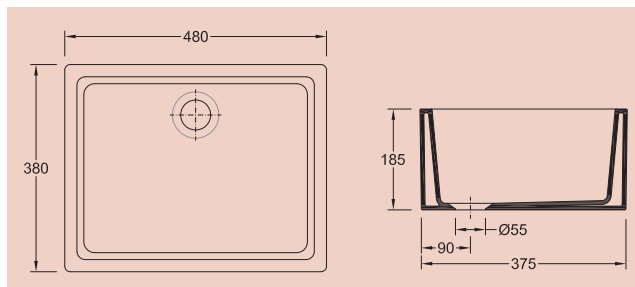

**PIA SILVES**

REF

BRANCO  
BLANCO  
WHITE

Pila Silves  
Sink Silves  
(51x40x19 cm)

78616xx2C

XX= 00

102 €

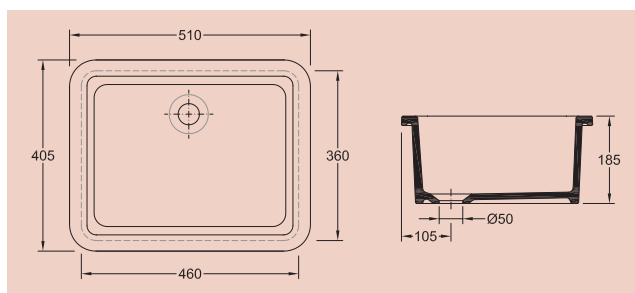

**PIA MONCHIQUE**

REF

BRANCO  
BLANCO  
WHITE

Pila Monchique  
Sink Monchique  
(46x46x27 cm)

78618xx2C

XX= 00

176 €

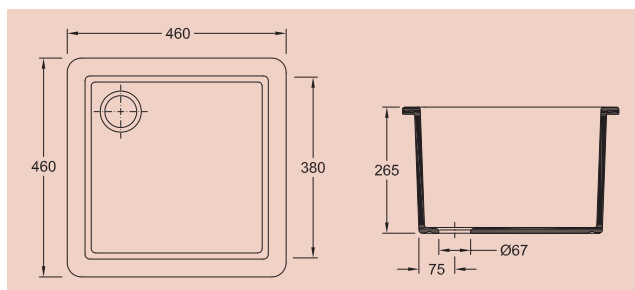

**PIA DE DESPEJO**

REF

BRANCO  
BLANCO  
WHITE

Pila de descarga  
Discharge sink  
(32x32x22 cm)

18614xx2C

XX= 00

51 €

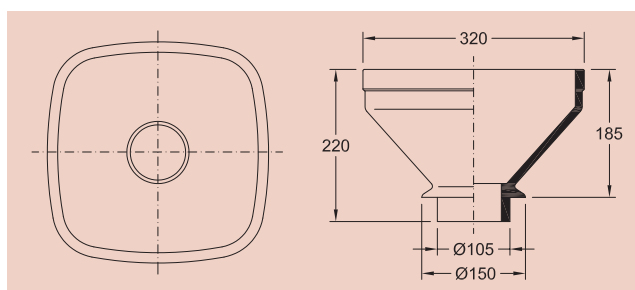



BRANCO  
BLANCO  
WHITE

REF

**PIA HOSPITALAR**

XX= 00

Pila Vertedero  
Medical slop hooper

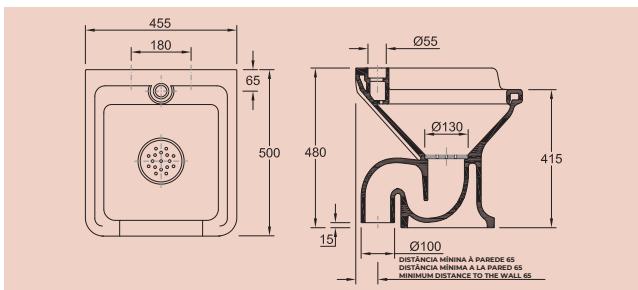

202 €

18613xx2K

(50x46x48 cm)

124 €

55003001

Rejilla cromada para vertedero  
Stainless steel grid

**GRADE INOX**

BRANCO  
BLANCO  
WHITE

REF

**LAVA-ROUPA MOZELA**

XX= 00

Lavadero Mozela  
Washer Mozela

102 €

78660xx2C

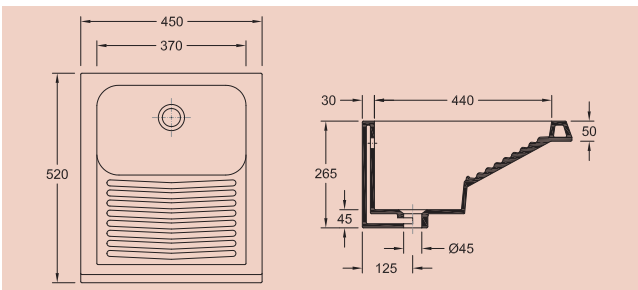

BRANCO  
BLANCO  
WHITE

REF

**MÓVEL P/ LAVA-ROUPA MOZELA (KIT)**

Mueble p/ lavadero Mozela (kit)  
Furniture for Mozela washer (kit)

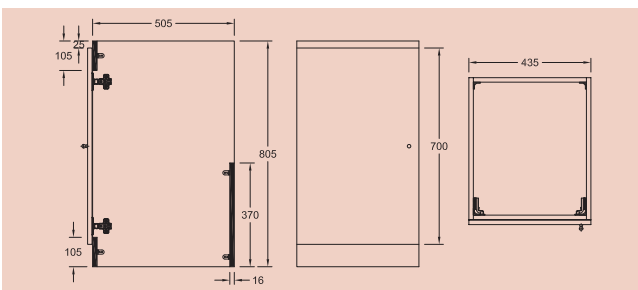

132 €

55332010

(51x44x81 cm)

5 €

55007003

**KIT FIXAÇÃO Nº3 (BACIA)**

Kit de fijación nº3 (inodoro)  
Fixing kit nº3 (WC)





- 
- 
- 
- 
- 
- 
- 
- 
- 
- 



# BASES DE CHUVEIRO

## PLATOS DE DUCHA

### SHOWER TRAYS

**CERÂMICAS** 208  
EN CERÁMICA  
CERAMIC

**EM RESINA COM CARGA MINERAL** 211  
EN RESINA CON CARGA MINERAL  
RESIN WITH MINERAL CHARGE



CERÂMICAS | EN CERÁMICA | CERAMIC



**EGG**  
PAG 208

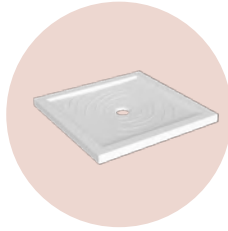

**AQUA**  
PAG 208

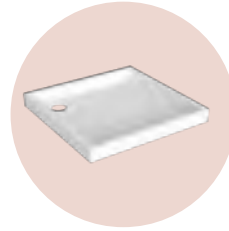

**DOURO PLUS**  
PAG 208

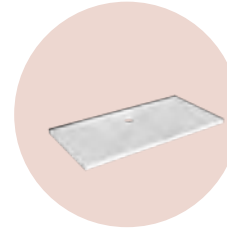

**LUCA**  
PAG 208

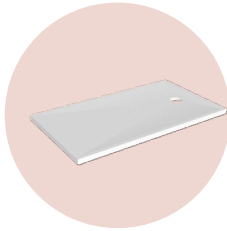

**BERNA**  
PAG 209

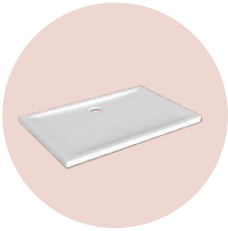

**PÁDUA**  
PAG 209

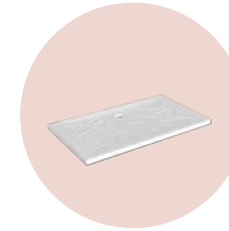

**ARIS**  
PAG 209

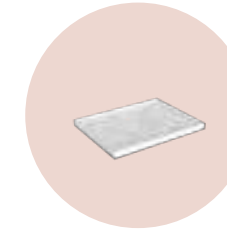

**LUSA**  
PAG 210

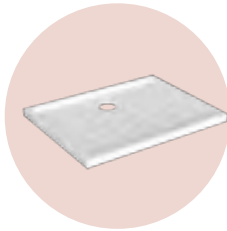

**DANILO**  
PAG 210

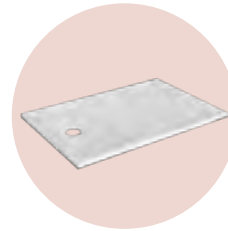

**FLOW**  
PAG 210

RESINA COM CARGA MINERAL | EN RESINA CON CARGA MINERAL  
RESIN WITH MINERAL CHARGE

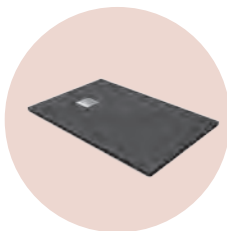

**IKO**  
PAG 211

		Comprimento / Largo / Length (cm) – A															
		70	80	90	100	110	120	130	140	150	160	170	180	190	200	210	220
Largura / Ancho / Width (cm) – B	70	35	35	35	35	35	45	45	45	45	45	45	45	45	45	45	45
	75	-	35	35	35	35	45	45	45	45	45	45	45	45	45	45	45
	80	-	35	35	35	35	45	45	45	45	45	45	45	45	45	45	45
	90	-	-	-	35	35	45	45	45	45	45	45	45	45	45	45	45
	100	-	-	-	35	35	45	45	45	45	45	45	45	45	45	45	45
	110	-	-	-	-	35	45	45	45	45	45	45	45	45	45	45	45
120	-	-	-	-	-	45	45	45	45	45	45	45	45	45	45	45	
		Distância lateral ao centro da válvula / valve (cm) - C															

## CERÂMICA ANTIDERRAPANTE EM HIGHPOR

Revestimiento cerámico antideslizante  
Non-slip ceramic coating



**Resistência às manchas**

**Resistencia a las manchas**

**Stain resistance**



**Fácil limpeza**

**Fácil limpieza**

**Easy cleaning**



**Resistência ao fogo**

**Resistente al fuego**

**Fire resistance**



**Resistência ao ataque químico**

**Resistencia al ataque químico**

**Resistance to chemical attack**

Base 100% cerâmica e reciclável .  
Fácil escoamento e instalação.

HighPor® : Revestimento  
Cerâmico antiderrapante - Classe C

Plato de ducha 100% cerâmica y reciclable.  
Excelente flujo y facilidad de instalación.

HighPor®: Revestimiento cerámico  
antideslizante - Clase C

100% ceramic and recyclable shower tray.  
Excellent flow and ease of installation.

HighPor®: Non-slip ceramic coating - Class C

**IKO**

As bases de chuveiro em resina são fornecidas com válvula slim incluída  
Los platos de ducha de resina se suministran con válvula slim incluida  
The resin shower trays are supplied with slim valve included

Fabricadas com resinas de poliéster insaturadas tipo isoftálica neo pentil glicol.  
Superfície em Gelcoat sanitário, ligada por termofusão ao corpo da base.  
Fabricadas con resinas de poliéster insaturadas tipo isoftálica neo pentil glicol.  
Superficie en Gelcoat sanitario, ligada por termofusión al cuerpo de la base.  
Made with unsaturated polyester resins isophthalic type neo pentyl glycol. Surface  
in Sanitary Gelcoat, bonded by thermofusion to the body of the base.

- Principais características:
- Absorção de água de 0,1%
  - Excelentes propriedades mecânicas
  - Excelente resistência ao desgaste
  - Excelente resistência à degradação provocada pela humidade
  - Excelente resistência à acção dos solventes (acetona, diluentes, etc.)
  - Antiderrapante
  - Antibacteriano
- Uniformidade total de cor, permitindo cortes em dimensões não standard sem alteração do aspecto.
- Incluem válvula Slim
  - Garantia de 2 anos contra defeitos de fabrico

- Principales características:
- Absorción de agua del 0,1%
  - Excelentes propiedades mecánicas
  - Excelente resistencia al desgaste
  - Excelente resistencia a la degradación provocada por la humedad
  - Excelente resistencia a la acción de los solventes (acetona, diluyentes, etc.)
  - Antiderrapante
  - Antibacteriano
- Uniformidad total de color, permitiendo cortes en dimensiones no standard sin alteración del aspecto.
- Incluyen la válvula delgado
  - Garantía de 2 años contra defectos de fabricación

- Main features:
- Water absorption of 0,1%
  - Excellent mechanical properties
  - Excellent wear resistance
  - Excellent resistance to degradation caused by humidity
  - Excellent resistance to solvents (acetone, thinners, etc.)
  - Non-slip
  - Antibacterial
- Full uniformity of color, allowing cuts in non-standard dimensions without changing the appearance.
- Include Slim Valve
  - 2 year warranty against manufacturing defects



**EGG**

REF

BRANCO  
BLANCO  
WHITE

XX= 00

(90x90x5 cm)

39673xx2K

363 €

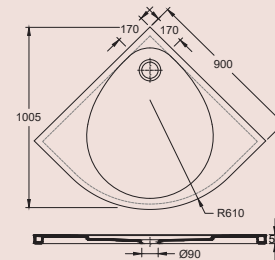

**AQUA**

REF

BRANCO  
BLANCO  
WHITE

XX= 00

(90x90x5,5 cm)

78639xx2K

220 €

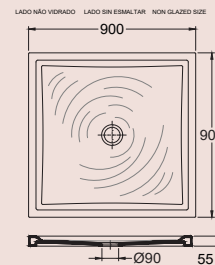

**DOURO PLUS**

REF

BRANCO  
BLANCO  
WHITE

XX= 00

(80x80x5 cm)

78670xx2K

160 €

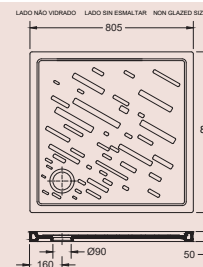
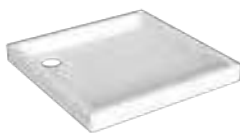

**LUCA**

REF

BRANCO  
BLANCO  
WHITE

XX= 00

(140x80x5 cm)

78672xx2K

390 €

(140x70x5 cm)

78671xx2K

340 €

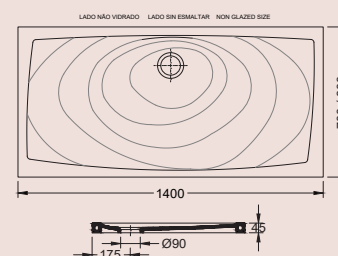

BRANCO  
BLANCO  
WHITE

REF

BERNA

XX= 00

375 €

78674xx2K

(130x80x4 cm)

341 €

78673xx2K

(130x75x4 cm)

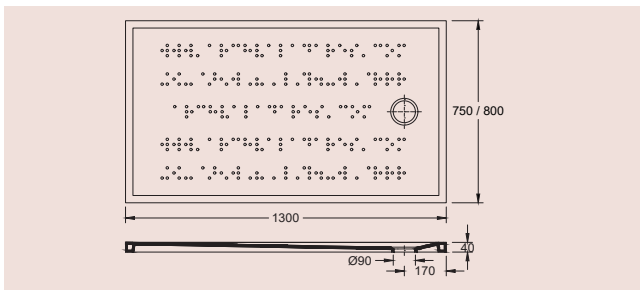

BRANCO  
BLANCO  
WHITE

REF

PÁDUA

XX= 00

259 €

78636xx2K

(120x80x5 cm)

220 €

78635xx2K

(100x80x5 cm)

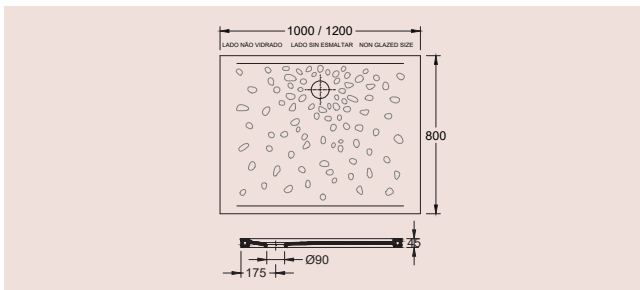

BRANCO  
BLANCO  
WHITE

REF

ARIS

XX= 00

230 €

78634xx2K

(120x70x4 cm)

190 €

78633xx2K

(100x70x4 cm)

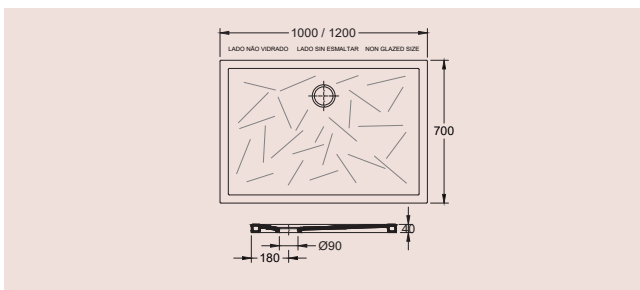

**LUSA**

REF

BRANCO  
BLANCO  
WHITE

XX= 00

(90x70x6 cm)

78632xx2K

160 €

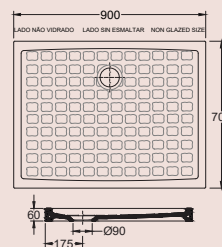

**DANILO**

REF

BRANCO  
BLANCO  
WHITE

XX= 00

(90x70x5 cm)

78631xx2K

151 €

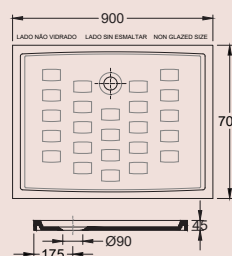

**FLOW**

REF

CORES ESPECIAIS  
COLORES ESPECIALES  
SPECIAL COLORS

XX=

10

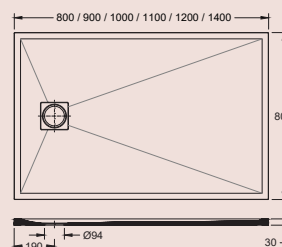

140x80 (140x80x3 cm)	78686xx2K	443 €
120x80 (120x80x3 cm)	78684xx2K	340 €
110x80 (110x80x3 cm)	78683xx2K	305 €
100x80 (100x80x3 cm)	78682xx2K	271 €
90x80 (90x80x3 cm)	78681xx2K	236 €
80x80 (80x80x3 cm)	78680xx2K	213 €

As bases de chuveiro em cerâmica são fornecidas com válvula slim incluída  
Los platos de ducha de cerámica se suministran con válvula slim incluida  
The ceramic shower trays are supplied with slim valve included



BRANCO  
BLANCO  
WHITE

ARDÓSIA  
PIZARRA  
SLATE

REF

IKO

XX=

00

47

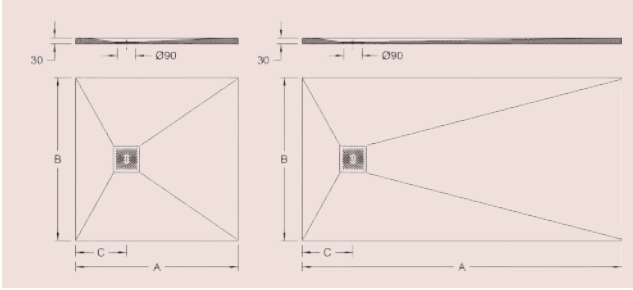

860 €	860 €	52504xx0	120x120x3 cm
644 €	644 €	52503xx0	110x110x3 cm
475 €	475 €	52502xx0	100x100x3 cm
403 €	403 €	52501xx0	90x90x3 cm
336 €	336 €	52500xx0	80x80x3 cm
297 €	297 €	52505xx0	70x70x3 cm
1.317 €	1.317 €	52597xx0	220x120x3 cm
1.214 €	1.214 €	52596xx0	220x110x3 cm
1.110 €	1.110 €	52565xx0	220x100x3 cm
1.007 €	1.007 €	52564xx0	220x90x3 cm
906 €	906 €	52563xx0	220x80x3 cm
906 €	906 €	52595xx0	220x75x3 cm
802 €	802 €	52594xx0	220x70x3 cm
1.264 €	1.264 €	52593xx0	210x120x3 cm
1.163 €	1.163 €	52592xx0	210x110x3 cm
1.067 €	1.067 €	52562xx0	210x100x3 cm
968 €	968 €	52561xx0	210x90x3 cm
863 €	863 €	52560xx0	210x80x3 cm
863 €	863 €	52591xx0	210x75x3 cm
766 €	766 €	52590xx0	210x70x3 cm
1.203 €	1.203 €	52589xx0	200x120x3 cm
1.110 €	1.110 €	52588xx0	200x110x3 cm
873 €	873 €	52559xx0	200x100x3 cm
780 €	780 €	52558xx0	200x90x3 cm
694 €	694 €	52557xx0	200x80x3 cm
694 €	694 €	52587xx0	200x75x3 cm
612 €	612 €	52586xx0	200x70x3 cm





IKO	REF	BRANCO BLANCO WHITE		ARDÓSIA PIZARRA SLATE	
		xx=	00		47
190x120x3 cm	52585xx0	1.149 €		1.149 €	
190x110x3 cm	52584xx0	1.056 €		1.056 €	
190x100x3 cm	52556xx0	827 €		827 €	
190x90x3 cm	52555xx0	743 €		743 €	
190x80x3 cm	52554xx0	666 €		666 €	
190x75x3 cm	52553xx0	666 €		666 €	
190x70x3 cm	52552xx0	590 €		590 €	
180x120x3 cm	52583xx0	1.093 €		1.093 €	
180x110x3 cm	52582xx0	1.007 €		1.007 €	
180x100x3 cm	52570xx0	792 €		792 €	
180x90x3 cm	52569xx0	702 €		702 €	
180x80x3 cm	52568xx0	636 €		636 €	
180x75x3 cm	52567xx0	636 €		636 €	
180x70x3 cm	52566xx0	558 €		558 €	
170x120x3 cm	52581xx0	1.034 €		1.034 €	
170x110x3 cm	52580xx0	953 €		953 €	
170x100x3 cm	52599xx0	749 €		749 €	
170x90x3 cm	52550xx0	666 €		666 €	
170x80x3 cm	52549xx0	595 €		595 €	
170x75x3 cm	52548xx0	595 €		595 €	
170x70x3 cm	52547xx0	533 €		533 €	
160x120x3 cm	52579xx0	981 €		981 €	
160x110x3 cm	52578xx0	906 €		906 €	
160x100x3 cm	52546xx0	717 €		717 €	
160x90x3 cm	52545xx0	636 €		636 €	
160x80x3 cm	52544xx0	578 €		578 €	
160x75x3 cm	52543xx0	578 €		578 €	
160x70x3 cm	52542xx0	505 €		505 €	
150x120x3 cm	52577xx0	924 €		924 €	
150x110x3 cm	52576xx0	851 €		851 €	
150x100x3 cm	52541xx0	791 €		791 €	
150x90x3 cm	52540xx0	663 €		663 €	
150x80x3 cm	52539xx0	538 €		538 €	
150x75x3 cm	52538xx0	538 €		538 €	
150x70x3 cm	52537xx0	479 €		479 €	

BRANCO BLANCO WHITE	ARDÓSIA PIZARRA SLATE	REF	IKO
xx=	47		
863 €	863 €	52575xx0	140x120x3 cm
802 €	802 €	52574xx0	140x110x3 cm
612 €	612 €	52536xx0	140x100x3 cm
551 €	551 €	52535xx0	140x90x3 cm
505 €	505 €	52534xx0	140x80x3 cm
505 €	505 €	52533xx0	140x75x3 cm
447 €	447 €	52532xx0	140x70x3 cm
810 €	810 €	52573xx0	130x120x3 cm
749 €	749 €	52572xx0	130x110x3 cm
590 €	590 €	52531xx0	130x100x3 cm
516 €	516 €	52530xx0	130x90x3 cm
458 €	458 €	52529xx0	130x80x3 cm
458 €	458 €	52528xx0	130x75x3 cm
426 €	426 €	52527xx0	130x70x3 cm
697 €	697 €	52571xx0	120x110x3 cm
548 €	548 €	52526xx0	120x100x3 cm
475 €	475 €	52525xx0	120x90x3 cm
440 €	440 €	52524xx0	120x80x3 cm
440 €	440 €	52523xx0	120x75x3 cm
416 €	416 €	52522xx0	120x70x3 cm
516 €	516 €	52521xx0	110x100x3 cm
452 €	452 €	52520xx0	110x90x3 cm
397 €	397 €	52519xx0	110x80x3 cm
397 €	397 €	52518xx0	110x75x3 cm
386 €	386 €	52517xx0	110x70x3 cm
423 €	423 €	52516xx0	100x90x3 cm
386 €	386 €	52515xx0	100x80x3 cm
386 €	386 €	52514xx0	100x75x3 cm
354 €	354 €	52513xx0	100x70x3 cm
368 €	368 €	52512xx0	90x80x3 cm
368 €	368 €	52511xx0	90x75x3 cm
326 €	326 €	52510xx0	90x70x3 cm
297 €	297 €	52506xx0	80x75x3 cm
336 €	336 €	52507xx0	80x70x3 cm
37 €		55019020	Válvula   Valve
21 €		55019030	Grelha   Rejilla   Grid



As bases de chuveiro em resina são fornecidas com válvula slim incluída  
 Los platos de ducha en resina se suministran con válvula slim incluída  
 The resin shower trays are supplied with slim valve included



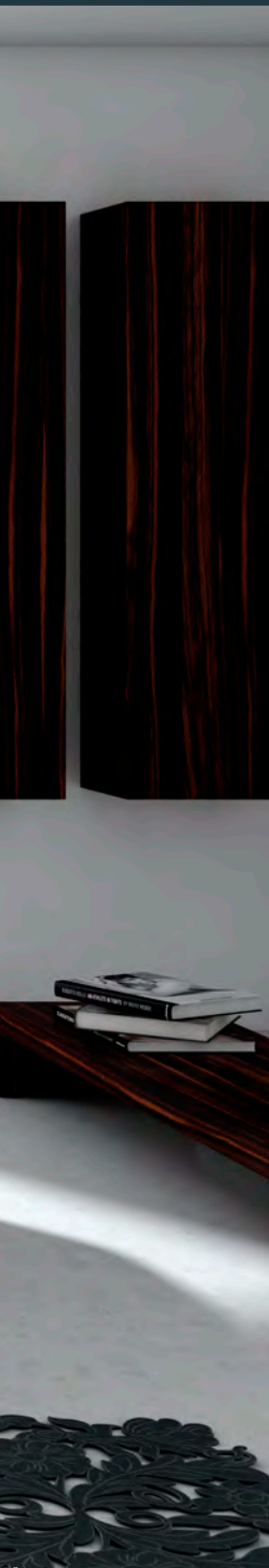

**BANHEIRAS**  
BAÑERAS  
BATHTUBS

<b>EGG</b>	218
<b>ZEN</b>	218
<b>MOON</b>	218
<b>LUX</b>	218
<b>STAR</b>	219
<b>CLASSIC</b>	219
<b>PLATANO</b>	219
<b>ARTIC</b>	220
<b>BALTIC</b>	220



**FREESTANDING**



**EGG**  
PAG 218



**ZEN**  
PAG 218

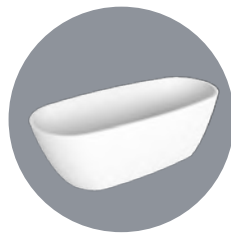

**MOON**  
PAG 218

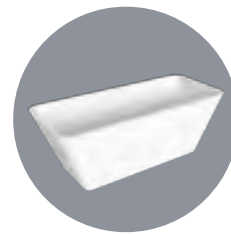

**LUX**  
PAG 218



**STAR**  
PAG 219



**CLASSIC**  
PAG 219



**PLATANO**  
PAG 219

**ACRÍLICAS | ACRÍLICO | ACRYLIC**



**ARTIC**  
PAG 220



**BALTIC**  
PAG 220



**EGG**

REF

BRANCO  
BLANCO  
WHITE

(170x70x50 cm)

52100000

7.441 €

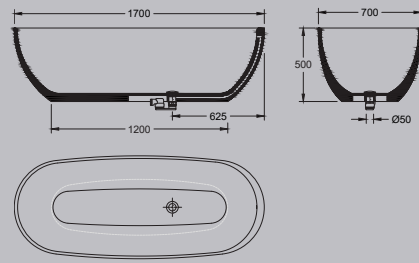

**ZEN**

REF

BRANCO  
BLANCO  
WHITE

(190x100x53 cm)

51100204

4.658 €

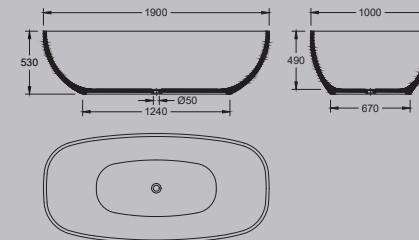

**MOON**

REF

BRANCO  
BLANCO  
WHITE

(170x72x55 cm)

51100206

4.534 €

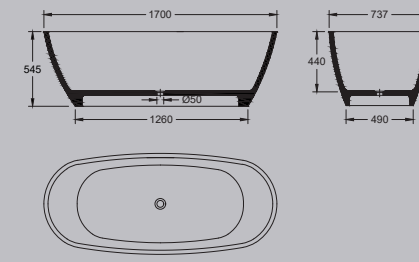

**LUX**

REF

BRANCO  
BLANCO  
WHITE

(165x70x58 cm)

51100202

4.099 €

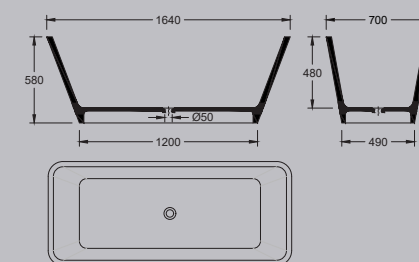



BRANCO  
BLANCO  
WHITE

REF

STAR

4.311 €

51100201

(178x84x63cm)

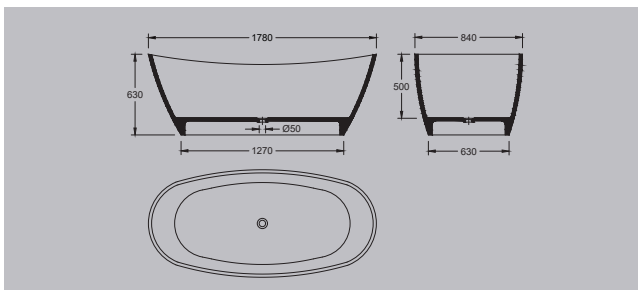

BRANCO  
BLANCO  
WHITE

REF

CLASSIC

3.974 €

51100001

(168x76x65 cm)

4.400 €

51100002

(175x82x55 cm)

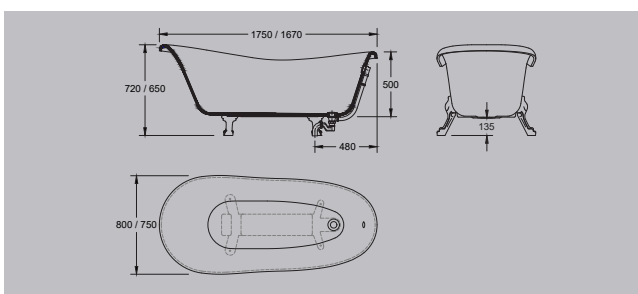

Banheiras Classic fornecidas com pés e sistema de esgoto cromados.  
Bañeras Classic suministradas con pies y sistema de alcantarillado cromo.  
Classic bathtubs supplied with chrome feet and sewage system.

Em opção, os pés e o sistema de esgoto podem ser em branco ou em cobre velho.  
Opcionalmente, los pies y el sistema de alcantarillado pueden ser en blanco o en cobre viejo.  
Optionally, the feet and the sewer system can be in white or in old copper.

BRANCO  
BLANCO  
WHITE

REF

PLATANO

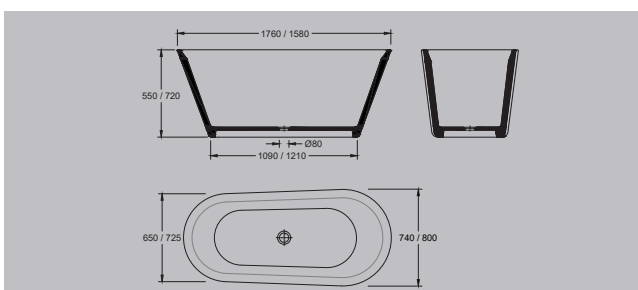

2.976 €

51101001

(176x80x72 cm)

2.851 €

51101002

(158x74x55 cm)

Inclui válvula de descarga horizontal  
Incluye válvula de descarga horizontal  
Includes horizontal discharge valve



**ARTIC**

REF

BRANCO  
BLANCO  
WHITE

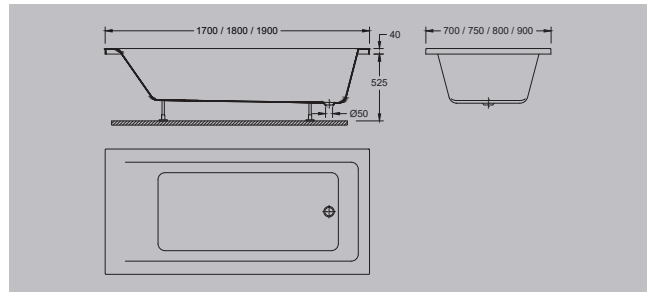

190x90	51614000	726 €
180x80	51613000	494 €
170x75	51612000	402 €
170x70	51611000	387 €

**BALTIC**

REF

BRANCO  
BLANCO  
WHITE

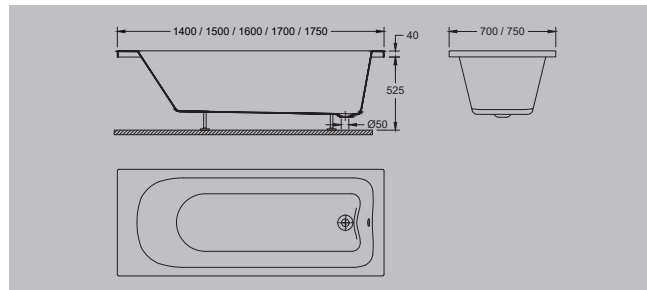

175x70	51627000	297 €
170x75	51626000	297 €
170x70	51625000	286 €
160x75	51624000	286 €
160x70	51623000	274 €
150x70	51622000	274 €
140x70	51621000	274 €

CROMADO  
CROMO  
CHROME

REF

CHASSI

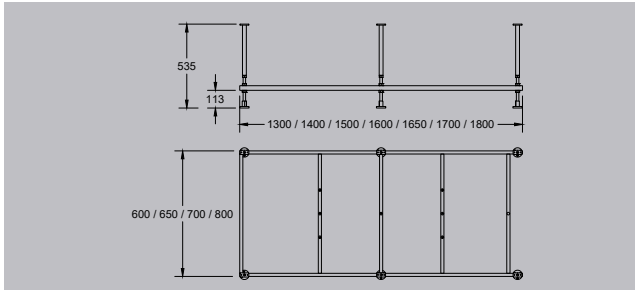

138 €

55570009

**PARA BANHEIRA 190x90**

Para bañera 190x90  
For bathtub 190x90

(1800x800x534mm)

117 €

55570008

**PARA BANHEIRA 180x80**

Para bañera 180x80  
For bathtub 180x80

(1700x700x534mm)

104 €

55570007

**PARA BANHEIRA 175x70**

Para bañera 175x70  
For bathtub 175x70

(1650x600x534mm)

109 €

55570006

**PARA BANHEIRA 170x75**

Para bañera 170x75  
For bathtub 170x75

(11600x650x534mm)

97 €

55570005

**PARA BANHEIRA 170x70**

Para bañera 170x70  
For bathtub 170x70

(1600x600x534mm)

97 €

55570004

**PARA BANHEIRA 160x75**

Para bañera 160x75  
For bathtub 160x75

(1500x650x534mm)

91 €

55570003

**PARA BANHEIRA 160x70**

Para bañera 160x70  
For bathtub 160x70

(1500x600x534mm)

87 €

55570002

**PARA BANHEIRA 150x70**

Para bañera 150x70  
For bathtub 150x70

(1400x600x534mm)

80 €

55570001

**PARA BANHEIRA 140x70**

Para bañera 140x70  
For bathtub 140x70

(1300x600x534mm)

**CONJUNTO PÉS**

REF

CROMADO  
CROMO  
CHROME

Juego de Pies  
Feet Set

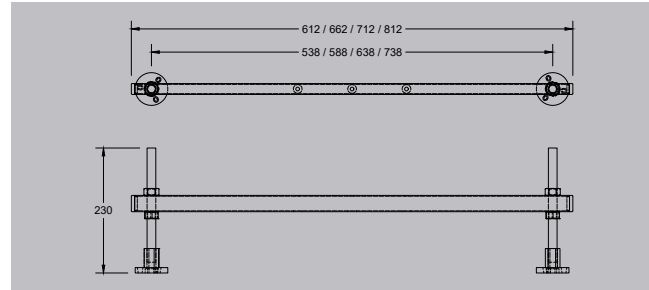

**PARA BANHEIRA 90CM**

Para bañera ancho 90cm  
For bathtub width 90cm

(812x230mm)

55560004

43 €

**PARA BANHEIRA 80CM**

Para bañera ancho 80cm  
For bathtub width 80cm

(712x230mm)

55560003

36 €

**PARA BANHEIRA 75CM**

Para bañera ancho 75cm  
For bathtub width 75cm

(662x230mm)

55560002

29 €

**PARA BANHEIRA 70CM**

Para bañera ancho 70cm  
For bathtub width 70cm

(612x230mm)

55560001

29 €

BRANCO  
BLANCO  
WHITE

REF

**PAINEIS**

Paneles  
Panels

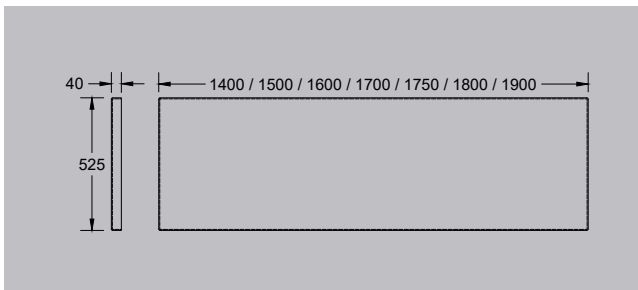

**FRONTAL**

Frontal  
Frontal

242 €	51727000	190
201 €	51726000	180
201 €	51725000	175
179 €	51724000	170
179 €	51723000	160
159 €	51722000	150
159 €	51721000	140

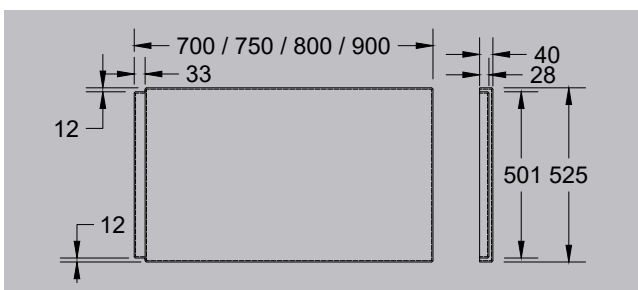

**LATERAL**

Lateral  
Lateral

198 €	51714000	90
138 €	51713000	80
109 €	51712000	75
104 €	51711000	70



# RESGUARDOS

## MAMPARAS

### SHOWER CABINS

<b>OPALA</b>	228
<b>RUBI</b>	229
<b>PURA</b>	230
<b>SPLASH</b>	231

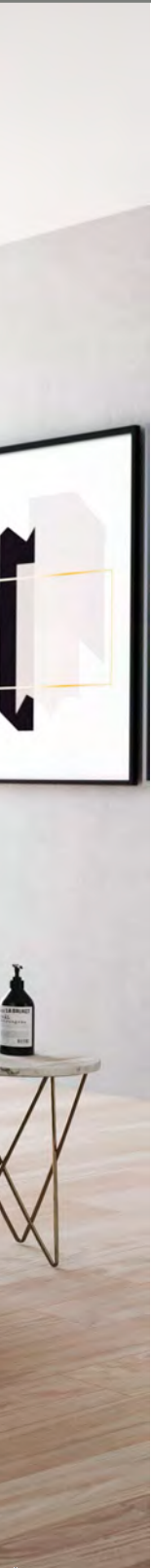



## OPALA

Frontal com porta de correr e painel fixo. Produzido em vidro temperado de 8mm (porta de correr) e de 10mm (folha fixa) UNE-EN 12150-2. Altura de 1950mm. Componentes em aço inox. Calha de retenção inferior. Fecho magnético. Este painel permite montagem como painel frontal e como painel de canto, ligando com os painéis fixos até 800mm.



Frontal con puerta corredera y panel fijo. Producido en vidrio templado de 8 mm (puerta corredera) y 10 mm (hoja fija) UNE-EN 12150-2. Altura de 1950 mm. Componentes de acero inoxidable. Riel de retención inferior. Cierre magnético. Este panel permite el montaje como panel frontal y como panel de esquina, conectando con paneles fijos de hasta 800 mm.



Front with sliding door and fixed panel. Produced in tempered glass of 8mm (sliding door) and 10mm (fixed leaf) UNE-EN 12150-2. 1950mm height. Stainless steel components. Lower retaining rail. Magnetic closure. This panel allows assembly as a front panel and as a corner panel, connecting with fixed panels up to 800mm.



## RUBI

Frontal com duas folhas articuladas. Produzido em vidro temperado de 6mm UNE-EN 12150-2. Altura de 1950mm. Perfis em alumínio. Puxador e acessórios cromados. Dobradiças em aço inox. Fecho magnético. Este painel permite montagem como painel frontal e como painel de canto, ligando com o painel fixo até 800mm.



Frontal con dos hojas abisagradas. Realizado en vidrio templado de 6 mm UNE-EN 12150-2. 1950 mm de altura. Perfiles de aluminio. Tirador y accesorios cromados. Bisagras de acero inoxidable. Cierre magnético. Este panel permite el montaje como panel frontal y como panel de esquina, conectando con el panel fijo hasta 800 mm.

Front with two hinged leaves. Produced in 6mm tempered glass UNE-EN 12150-2. 1950mm height. Aluminum profiles. Chrome handle and accessories. Stainless steel hinges. Magnetic closure. This panel allows assembly as a front panel and as a corner panel, connecting with the fixed panel up to 800mm.



## PURA

Painel em vidro temperado de 8mm de espessura e 2,00m de altura com perfis em alumínio cromado brilho e extensor de suporte em aço inox. Vidro com tratamento anticálcio (fácil limpeza)



Panel de vidrio templado de 8 mm de espesor y 2,00 m de altura con perfiles de aluminio cromado brillante y extensor de soporte de acero inoxidable. Vidrio con tratamiento antical (fácil limpieza)

High tempered glass panel with 8mm thick and 2,00m and with gloss chrome aluminium profiles and stainless steel support extender. Glass with anti-calc treatment (easy cleaning)



## SPLASH FRONTAL | SPLASH FRONT PANEL

Frontal com um painel fixo e uma porta de correr. Produzidos com perfis de alumínio cromado brilhante e vidro temperado de 6mm de espessura e 2,00m de altura. Vidro com tratamento anticalcário (fácil limpeza)

Frontal con panel fijo y puerta corredera. Fabricado con perfiles de aluminio cromado brillante y cristal templado de 6 mm de espesor y 2,00 m de altura. Vidrio con tratamiento antical (fácil limpieza)

Front with a fixed panel and a sliding door. Produced with profiles of shiny chrome aluminum and tempered glass 6mm thick and 2.00m high. Glass with anti-calc treatment (easy cleaning)



## SPLASH MÓDULOS | SPLASH MODULES

Cabine de canto com painéis fixos e portas de correr de abertura central. Produzidas com perfis de alumínio cromado brilhante e vidro temperado de 6mm de espessura e 2,00m de altura. Vidro com tratamento anticalcário (fácil limpeza)

Mampara de esquina con paneles fijos y puertas correderas con apertura central. Fabricado con perfiles de aluminio cromado brillante y vidrio templado de 6 mm de espesor y 2,00 m de altura. Vidrio con tratamiento antical (fácil limpieza)

Corner cabin with fixed panels and sliding doors with central opening. Produced with profiles of shiny chrome aluminum and tempered glass 6mm thick and 2.00m high. Glass with anti-calc treatment (easy cleaning)



**PAINEL FRONTAL C/ PORTA DE CORRER** REF

Panel frontal con puerta corredera  
Front panel with sliding door

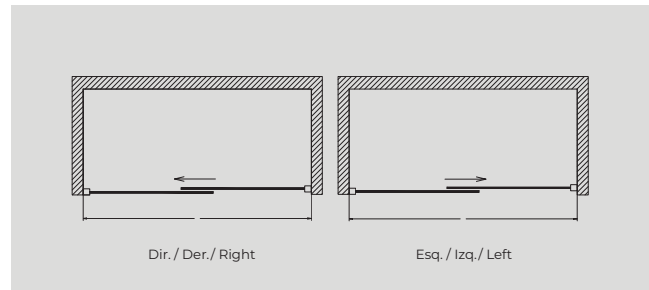

**1401-1600 DIR./ESQ.**

1401-1600 dir./izq.  
1401-1600 right/left

52762072D/E      1.651 €

**1201-1400 DIR./ESQ.**

1201-1400 dir./izq.  
1201-1400 right/left

52762062D/E      1.542 €

**1000-1200 DIR./ESQ.**

1000-1200 dir./izq.  
1000-1200 right/left

52762052D/E      1.433 €

**PAINEL FRONTAL C/ PORTA DE CORRER E LATERAL ATÉ 800** REF

Panel frontal con puerta corredera y lateral hasta 800  
Front panel with sliding door and side panel up to 800

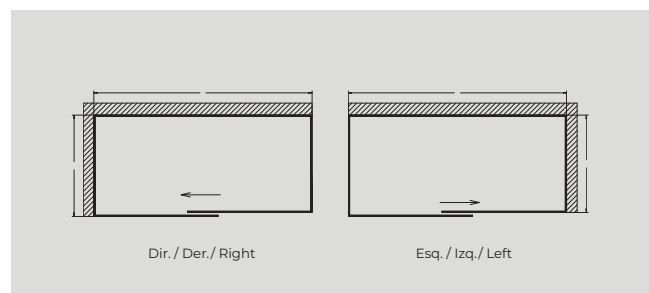

**1401-1600x800 DIR./ESQ.**

1401-1600x800 dir./izq.  
1401-1600x800 right/left

52762102D/E      2.207 €

**1201-1400x800 DIR./ESQ.**

1201-1400x800 dir./izq.  
1201-1400x800 right/left

52762092D/E      2.100 €

**1000-1200x800 DIR./ESQ.**

1000-1200x800 dir./izq.  
1000-1200x800 right/left

52762082D/E      1.991 €

REF

**PAINEL FRONTAL COM 2 FOLHAS ARTICULADAS**Panel frontal con 2 hojas con bisagras  
Front Panel with 2 hinged sheets**640-800 DIR./ESQ.**640-800 dir./izq.  
640-800 right/left

1.094 €

52762012D/E

**801-1000 DIR./ESQ.**801-1000 dir./izq.  
801-1000 right/left

1.155 €

52762022D/E

REF

**PAINEL FRONTAL COM 2 FOLHAS ARTICULADAS E LATERAL ATÉ 800MM**Panel frontal con 2 hojas con bisagras y lateral hasta 800mm  
Front Panel with 2 hinged sheets and a side panel up to 800mm**640-800x800 DIR./ESQ.**640-800x800 dir./izq.  
640-800x800 right/left

1.524 €

52762032D/E

**801-1000x800 DIR./ESQ.**801-1000x800 dir./izq.  
801-1000x800 right/left

1.606 €

52762042D/E



PURA

REF



**PAINEL 120**

Panel 120  
Panel 120

52763232

454 €

**PAINEL 100**

Panel 100  
Panel 100

52763222

412 €

**PAINEL 90**

Panel 90  
Panel 90

52763212

391 €

**PAINEL 80**

Panel 80  
Panel 80

52763202

360 €

REF

## PAINEL FRONTAL

Panel frontal  
Front panel

676 €	52763162	160
654 €	52763152	150
634 €	52763142	140
612 €	52763132	130
592 €	52763122	120
570 €	52763112	110
550 €	52763102	100

REF

## PAINEL LATERAL FIXO

Panel lateral fijo  
Fixed side panel

317 €	52763192	90
296 €	52763182	80
286 €	52763172	70



**SPLASH MÓDULOS**

REF

Splash módulos  
Splash modules



120 (118,5 - 120)	52763052	376 €
100 (98,5 - 100)	52763042	344 €
90 (88,5 - 90)	52763032	334 €
80 (78,5 - 80)	52763022	312 €
75 (73,5 - 75)	52763012	306 €
70 (68,5 - 70)	52763002	296 €

Dimensão do resguardo	Dimensión de la mampara	Cabine dimension	Módulos/ Modules
	70x70		52763002 + 52763002
	75x75		52763012 + 52763012
	80x80		52763022 + 52763022
	90x90		52763032 + 52763032
	100x100		52763042 + 52763042
	120x120		52763052 + 52763052
	80x70		52763022 + 52763002
	90x70		52763032 + 52763002
	100x70		52763042 + 52763002
	120x70		52763052 + 52763002

Dimensão do resguardo	Dimensión de la mampara	Cabine dimension	Módulos/ Modules
	80x75		52763022 + 52763012
	90x75		52763032 + 52763012
	100x75		52763042 + 52763012
	120x75		52763052 + 52763012
	90x80		52763032 + 52763022
	100x80		52763042 + 52763022
	120x80		52763052 + 52763022

REF

RESGUARDO EGG 90

856 €

52750201

Mampara EGG 90  
Shower EGG 90

Resguardo com dois painéis fixos e duas portas de correr. Produzidos com perfis de alumínio metalizado e vidro temperado de 4mm. Rolamentos de esferas em inox. Altura de 185 cm

Mampara con dos paneles fijos y dos puertas correderas. Fabricado con perfiles de aluminio metalizado y vidrio templado de 4 mm. Rodamientos de bolas de acero inoxidable. Altura 185 cm

Cabin with two fixed panels and two sliding doors. Produced with metallized aluminium profiles and 4mm tempered glass. Stainless steel ball bearings. Height 185 cm







# ACESSÓRIOS CERÂMICOS

ACCESORIOS EN CERÁMICA  
CERAMIC ACCESSORIES

<b>BLEND</b>	238
<b>NEOCLÁSSICO</b>	240
<b>ALFA</b>	242



**BLEND**



**CABIDE**  
PERCHA  
HANGER  
PAG 238



**PORTA PIAÇABA**  
ESCOBILLERO  
TOILET BRUSH HOLDER  
PAG 238

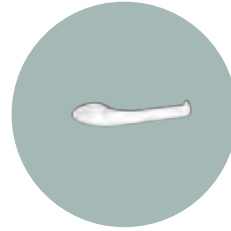

**PORTA-ROLO**  
PORTARROLLO  
TOILET PAPER HOLDER  
PAG 238

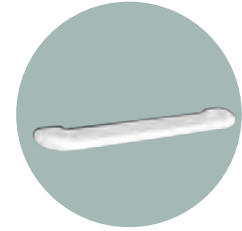

**PRATELEIRA**  
ESTANTE  
SHELF  
PAG 239



**VASSOURA**  
ESCOBILLA  
BRUSH  
PAG 238

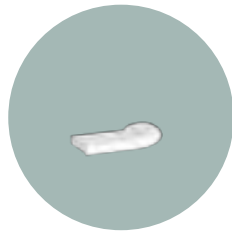

**SABONETEIRA PEQUENA**  
JABONERA PEQUEÑA  
SMALL SOAP TRAY  
PAG 239



**SABONETEIRA GRANDE**  
JABONERA GRANDE  
LARGE SOAP TRAY  
PAG 239

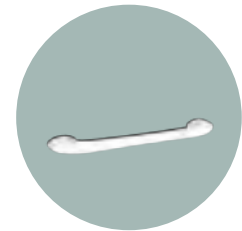

**TOALHEIRO**  
TOALLERO  
PORCELAIN TOWEL RAIL  
PAG 239

**NEOCLÁSSICO**



**CABIDE**  
PERCHA  
HANGER  
PAG 240



**PORTA PIAÇABA**  
ESCOBILLERO  
TOILET BRUSH HOLDER  
PAG 240



**PORTA-ROLO**  
PORTARROLLO  
TOILET PAPER HOLDER  
PAG 240

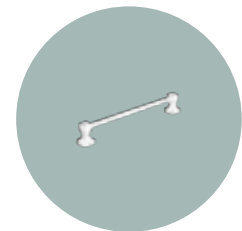

**VARÃO DE TOALHEIRO**  
BARRA DE TOALLERO  
PORCELAIN TOWEL RAIL  
PAG 241



**VASSOURA**  
ESCOBILLA  
BRUSH  
PAG 240



**SABONETEIRA PEQUENA**  
JABONERA PEQUEÑA  
SMALL SOAP TRAY  
PAG 241



**SABONETEIRA GRANDE**  
JABONERA GRANDE  
LARGE SOAP TRAY  
PAG 241

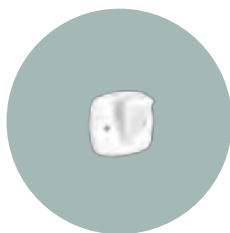

**CABIDE**  
PERCHA  
HANGER  
PAG 242



**PORTA PIAÇABA**  
ESCOBILLERO  
TOILET BRUSH HOLDER  
PAG 242



**PORTA-ROLO**  
PORTARROLLO  
TOILET PAPER HOLDER  
PAG 242

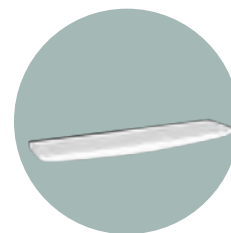

**PRATELEIRA**  
ESTANTE  
SHELF  
PAG 243



**VASSOURA**  
ESCOBILLA  
BRUSH  
PAG 242

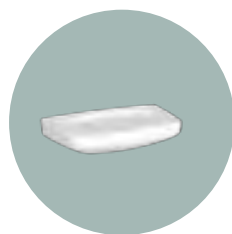

**SABONETEIRA PEQUENA**  
JABONERA PEQUEÑA  
SMALL SOAP TRAY  
PAG 243



**SABONETEIRA GRANDE**  
JABONERA GRANDE  
LARGE SOAP TRAY  
PAG 243



**VARÃO DE TOALHEIRO**  
BARRA DE TOALLERO  
PORCELAIN TOWEL RAIL  
PAG 244



**CABIDE**

REF

BRANCO  
BLANCO  
WHITE

Percha  
Hanger

24001xx2

XX= 00

17 €

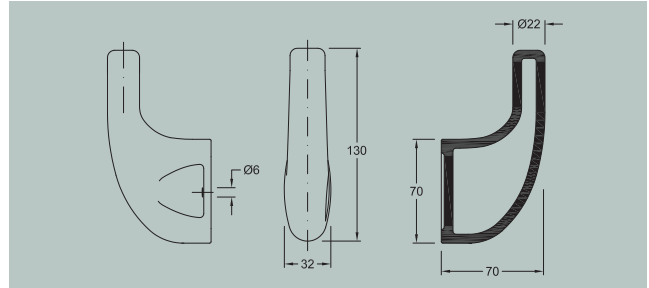

**PORTA-PIAÇABA**

REF

BRANCO  
BLANCO  
WHITE

Escobillero  
Toilet brush holder

24100xx2

XX= 00

38 €

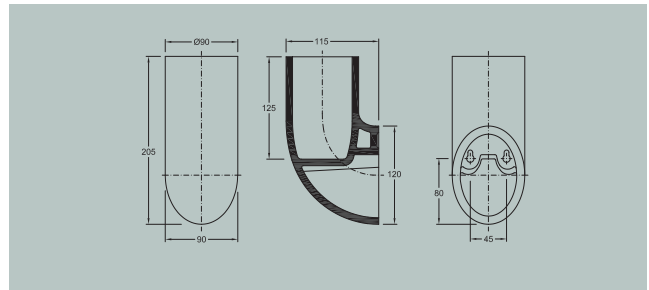

**VASSOURA**

REF

CROMADO  
CROMO  
CHROME

Escobilla  
Brush

55020005

XX= 00

12 €



**PORTA-ROLO**

REF

BRANCO  
BLANCO  
WHITE

Portarollo  
Toilet paper holder

24200xx2

XX= 00

25 €

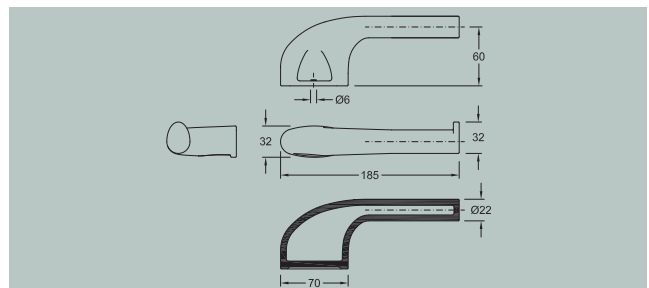

BRANCO  
BLANCO  
WHITE

REF

PRATELEIRA

XX= 00

Estante  
Shelf

41 €

24350xx2

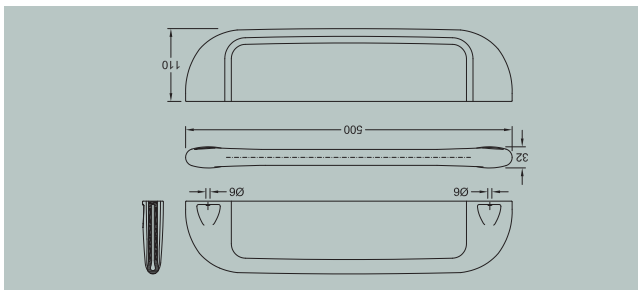

BRANCO  
BLANCO  
WHITE

REF

SABONETEIRA PEQUENA

XX= 00

Jabonera pequeña  
Small soap tray

25 €

24400xx2

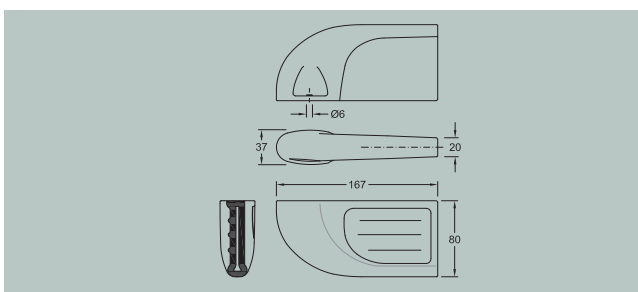

BRANCO  
BLANCO  
WHITE

REF

SABONETEIRA GRANDE

XX= 00

Jabonera grande  
Large soap

37 €

24401xx2

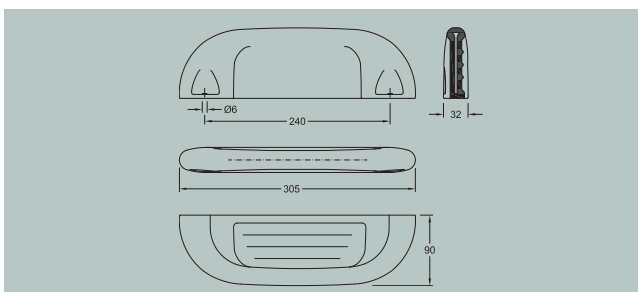

BRANCO  
BLANCO  
WHITE

REF

TOALHEIRO

XX= 00

Toallero  
Porcelain towel rail  
30 cm

21 €

24530xx2

25 €

24540xx2

40 cm

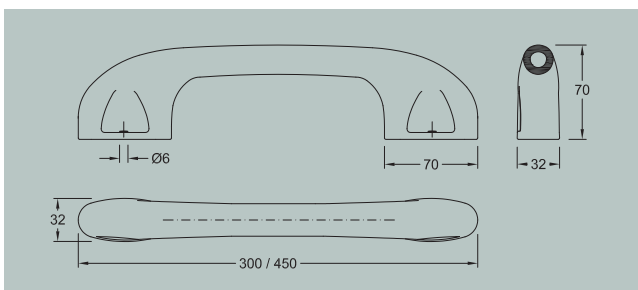

**CABIDE**

REF

BRANCO  
BLANCO  
WHITE

Percha  
Hanger

26001xx2

XX= 00

10 €

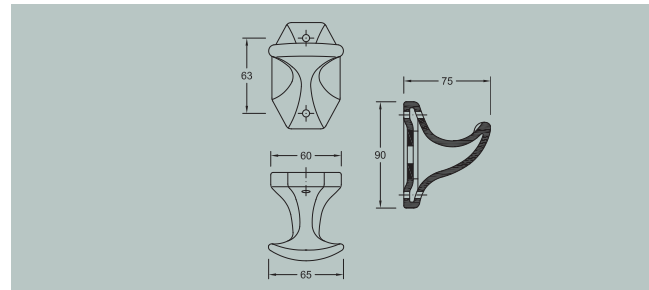

**PORTA-PIAÇABA**

REF

BRANCO  
BLANCO  
WHITE

Escobillero  
Toilet brush holder

26100xx2

XX= 00

32 €

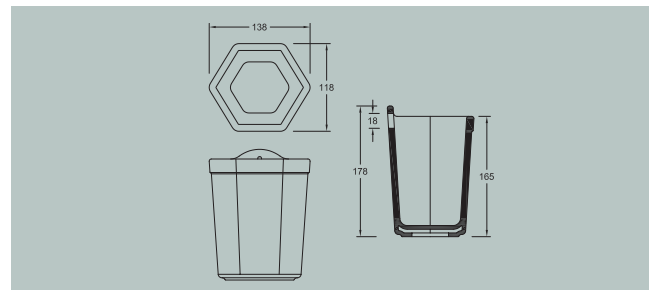

**VASSOURA**

REF

CROMADO  
CROMO  
CHROME

Escobilla  
Brush

55020005

XX= 00

12 €



**PORTA-ROLO**

REF

BRANCO  
BLANCO  
WHITE

Portarrollo  
Toilet paper holder

26200xx2

XX= 00

19 €

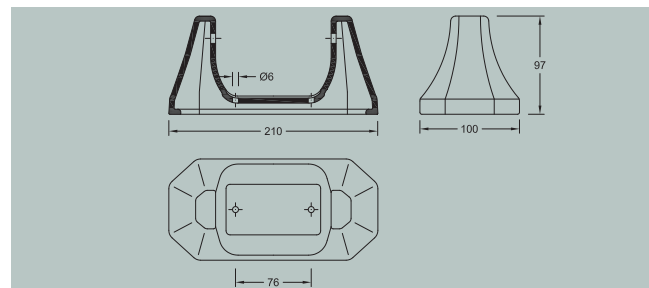

BRANCO  
BLANCO  
WHITE

REF

**SABONETEIRA PEQUENA**

XX= 00

Jabonera pequeña  
Small soap tray

20 €

26400xx2

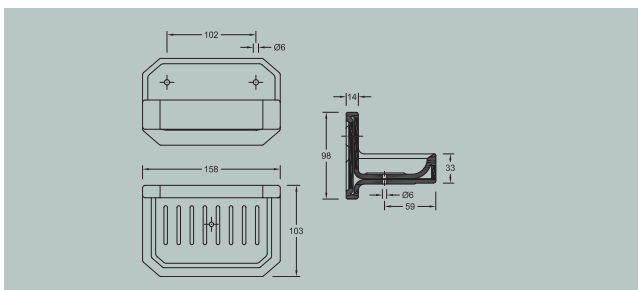

BRANCO  
BLANCO  
WHITE

REF

**SABONETEIRA GRANDE**

XX= 00

Jabonera grande  
Large soap tray

33 €

26404xx2

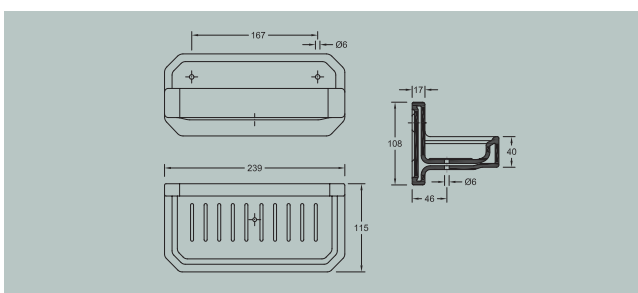

BRANCO  
BLANCO  
WHITE

REF

**VARÃO DE TOALHEIRO**

XX= 00

Barra de toallero  
Porcelain towel rail

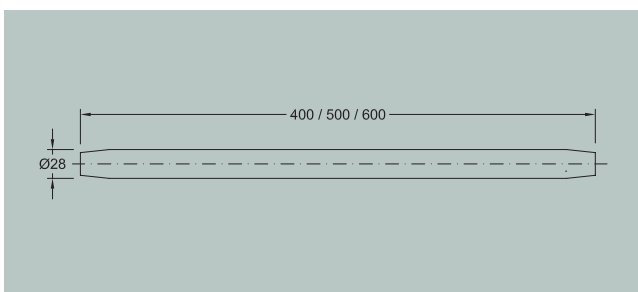

17 €

22630xx2

30 cm

18 €

22640xx2

40 cm

19 €

22650xx2

50 cm

26 €

22660xx2

60 cm

BRANCO  
BLANCO  
WHITE

REF

**SUPORE P/ VARÃO DE TOALHEIRO**

XX= 00

Suporte para barra de toallero  
Bracket for towel rail

12 €

26500xx2

**CABIDE**

REF

BRANCO  
BLANCO  
WHITEPercha  
Hanger

22001xx2

XX= 00

9 €

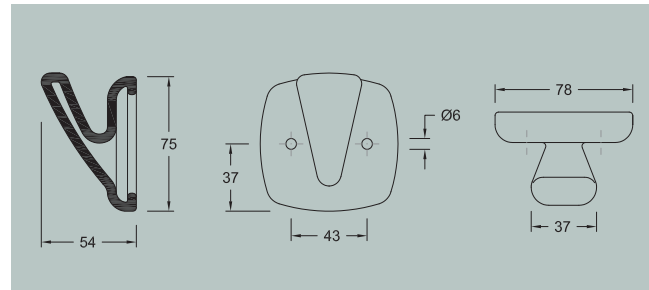
**PORTA-PIAÇABA**

REF

BRANCO  
BLANCO  
WHITEEscobillero  
Toilet brush holder

22100xx2

XX= 00

14 €

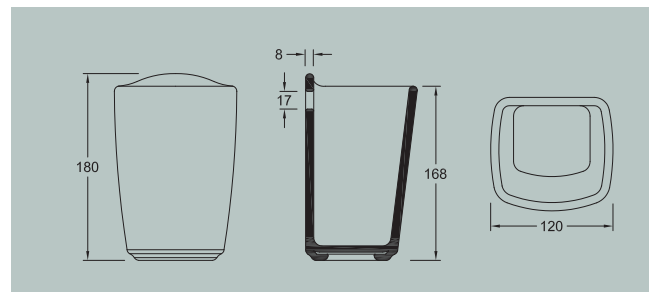
**VASSOURA**

REF

CROMADO  
CROMO  
CHROMEEscobilla  
Brush

55020005

XX= 00

12 €

**PORTA-ROLO**

REF

BRANCO  
BLANCO  
WHITEPortarollo  
Toilet paper holder

22200xx2

XX= 00

14 €

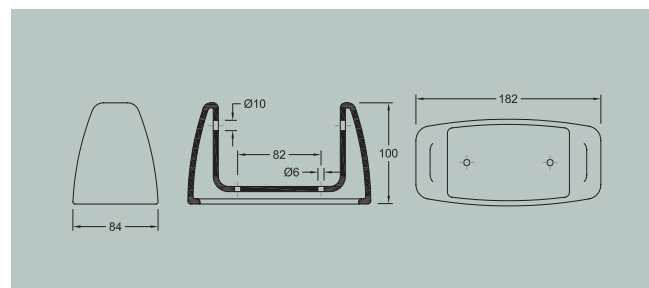



BRANCO  
BLANCO  
WHITE

REF

PRATELEIRA

XX= 00

Estante  
Shelf

33 €

22360xx2

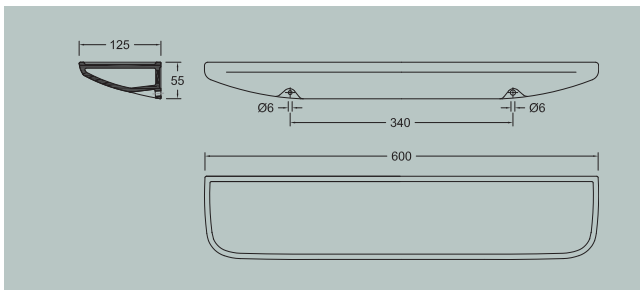

BRANCO  
BLANCO  
WHITE

REF

SABONETEIRA PEQUENA

XX= 00

Jabonera pequeña  
Small soap tray

15 €

22400xx2

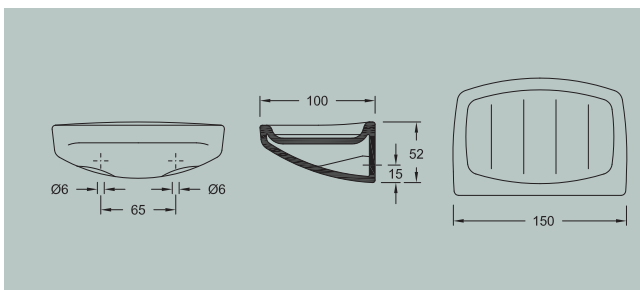

BRANCO  
BLANCO  
WHITE

REF

SABONETEIRA ESPONJEIRA

XX= 00

Jabonera empotrada  
Soap tray and sponge tray

38 €

22401xx2

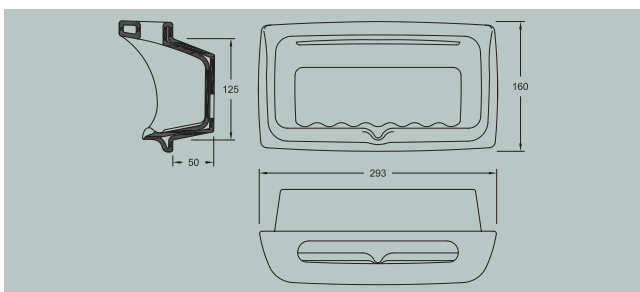

**VARÃO DE TOALHEIRO**

REF

BRANCO  
BLANCO  
WHITEBarra de toallero  
Porcelain towel rail

XX= 00

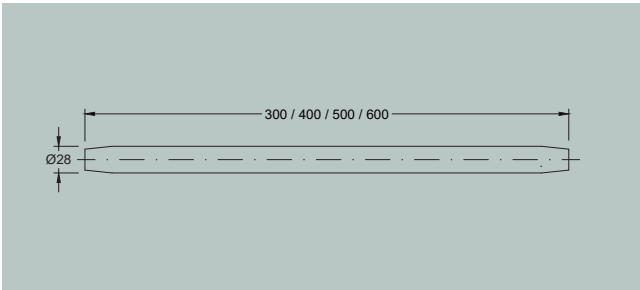

30 cm

22630xx2

17 €

40 cm

22640xx2

18 €

50 cm

22650xx2

19 €

60 cm

22660xx2

26 €

**SUORTE PARA VARÃO DE TOALHEIRO**

REF

BRANCO  
BLANCO  
WHITESoporte para barra de toallero  
Bracket for towel rail

XX= 00

22500xx2

10 €



## INTRODUÇÃO

Todas as relações comerciais entre a ARCH, SA e os seus Clientes são reguladas pelas seguintes “condições gerais de Venda” que conjuntamente com as “condições gerais de Pagamento” consideram-se integralmente aceites pelo comprador no ato da encomenda.

### 1. Catálogos, ofertas e encomendas

- 1.1 Todas as indicações e características constantes do material publicitário e informativo estão sujeitas às tolerâncias definidas pelas normas de regulamentação interna de acordo com o normativo do setor.
- 1.2 Qualquer encomenda realizada à ARCH,SA deverá ser realizada em formato escrito, com devida identificação do Cliente, data e descrição técnica suportada nas nossas referências de artigo.
- 1.3 Todas as encomendas serão, para todos os efeitos, passíveis de confirmação por escrito por parte do Cliente.
- 1.4 Qualquer condição estipulada pelo Cliente nos seus pedidos e que não esteja em conformidade com as presentes “condições gerais de Venda” bem como “condições gerais de Pagamento” serão consideradas sem efeito, com posterior confirmação escrita, pela ARCH, SA.

### 2. Suspensão das Encomendas

- 2.1 A ARCH, SA reserva o direito de suspender a execução de qualquer encomenda nos seguintes casos:
- Quando o Cliente não tiver dado cumprimento parcial ou total a contratos anteriores;
  - Quando por parte do Cliente se verificar recusa na recepção de encomendas após carga e expedição conforme prévia encomenda,
  - Sempre que se verifique conduta indevida do Cliente em prejuízo da ARCH, SA.

### 3. Entregas

- 3.1 Os prazos de entrega são acordados entre a ARCH, SA e o Cliente no decurso da encomenda. Se nada for formalmente estipulado entre as partes, o prazo de referência para entrega será de 30 dias úteis. Sempre que não for possível garantir um prazo acordado, a ARCH, SA compromete-se a avisar o Cliente e a combinar um novo prazo.
- 3.2 Toda e qualquer encomenda poderá ser executada por entregas parciais.
- 3.3 Os artigos e mercadorias consideram-se entregues ao Cliente no momento da carga do meio de transporte deste e a respectiva guia de remessa assinada pelo operador do transporte quando este é da responsabilidade do Cliente. Nestes casos não serão aceites reclamações posteriores por faltas ou dano em mercadoria entregue.
- 3.4 Sempre que a mercadoria é entregue em transporte da responsabilidade da ARCH, SA, esta considera-se entregue quando da validação de recepção de mercadoria no destinatário.
- 3.5 O acto de recepção da mercadoria por parte do Cliente implica a confirmação do conteúdo e conformidade da mesma de acordo com encomenda efectuada e/ou com documentos comprovativos de transporte. Qualquer anomalia deverá ser registada em Guia de remessa da ARCH, SA bem como na Guia de transporte.
- 3.6 Caso não seja possível verificar mercadoria no momento da entrega, o Cliente deverá assinalar nas Guias de Remessa e Transporte a referência “Sujeito a conferência”. Qualquer anomalia verificada deverá ser comunicada por escrito pelo Cliente aos nossos serviços comerciais em tempo útil e nunca superior a 5 dias úteis à data da recepção da mercadoria.
- 3.7 A ARCH, SA poderá recusar-se a efectuar o transporte de mercadoria sempre que :
  - O local de destino não seja o armazém do Cliente ou local definido no momento da encomenda.
  - O volume da encomenda não o justifique
  - Sempre que houver recusa de recepção de mercadoria sem motivos imputáveis à ARCH,SA., sendo nesse caso debitado ao Cliente o valor relativo ao transporte e a custos adicionais decorrentes dessa condição.
  - A ARCH, SA reserva-se o direito de considerar sem efeito toda a encomenda que aguarde mais de 30 dias após sua execução nas nossas instalações, sem que o Cliente proceda ao seu levantamento.

### 4. Preços

- 4.1 Os preços praticados são os constantes da tabela de preços da ARCH, SA em vigor no momento da expedição.
- 4.2 A Tabela de preços poderá ser alterada sem qualquer aviso prévio.
- 4.3 Em caso de publicação e divulgação de nova Tabela de Preços e no prazo de 8 dias úteis seguintes à sua divulgação, o Cliente poderá anular, por escrito, qualquer encomenda ainda não executada ou expedida pela ARCH, SA.
- 4.4 Consideram-se aceites pelos Clientes os preços constantes da nova tabela para as encomendas em curso e que não tenham sido objecto de anulação.
- 4.5 Os preços constantes da Tabela de Preços serão sempre líquidos de impostos em vigor, os quais serão devidamente discriminados em documentos de facturação.
- 4.6 Os preços constantes da Tabela de Preços serão acrescidos de despesas efectuadas com expedição e transporte da mercadoria e / ou embalagem especial quando solicitado pelo Cliente e aceite pela ARCH, SA.

### 5. Pagamentos

- 5.1 O pagamento das facturas rege-se pelas “Condições Gerais de Pagamento” da ARCH, SA em vigor à data da expedição.
- 5.2 Se o Cliente se constituir em mora, a ARCH, SA reserva-se o direito de suspender a execução de encomendas em curso de processamento ou recebidas entretanto.
- 5.3 Sempre que a ARCH, SA tomar conhecimento de factos e circunstâncias que originem fundado receio de incumprimento de obrigações por parte do Cliente, poderá suspender o processamento e entrega de encomendas efectuadas, salvo mediante garantias fundamentadas do Cliente que honrará os seus compromissos de pagamento em prazo acordado e aceite pela ARCH, SA

### 6. Garantia de Artigos Cerâmicos

- 6.1 A ARCH, SA dá garantia de 20 anos sobre todos os artigos cerâmicos Sanitários da sua conceção e produção, considerando a data de venda.
- 6.2 Os artigos que durante este período apresentem algum problema técnico ou de qualidade evidente e da responsabilidade da ARCH, SA, serão substituídos sem custos para o Cliente.
- 6.3 Para que a garantia seja ativada, é imprescindível que os defeitos sejam comunicados por escrito aos serviços comerciais da ARCH, SA, acompanhados dos respetivos documentos comprovativos da venda e entrega por parte da ARCH, SA para devida comprovação de origem e data de entrega.

6.4 A aceitação da reclamação será condicionada por validação técnica dos nossos serviços técnicos, para despistagem de causas não cobertas pela garantia aqui descrita, como uso indevido, deficiente instalação ou manutenção, danos de transporte, manipulações, reparações ou alterações efetuadas por terceiros, sem o nosso consentimento escrito.

6.5 A garantia sobre produtos cerâmicos por nós concebidos e produzidos, exclui toda e qualquer responsabilidade decorrente de consequências relativas a incompatibilidade técnica de instalações do Cliente, más condições de operação da instalação, assim como condições indevidas de armazenamento ou manuseamento e não aceitaremos nenhuma reclamação por despesas com as mesmas, assim como responsabilidades legais por danos ou prejuízos.

6.6 O material reclamado será repostado pela ARCH, SA no mais curto espaço de tempo e de acordo com a disponibilidade de material igual ao reclamado.

**7. Garantia de componentes não cerâmicos**

7.1 A ARCH, SA garante por período de 2 anos, desde a data de compra (comprovada), os produtos não cerâmicos por si comercializados e a seguir discriminados:

- Componentes dos mecanismos de descarga: Válvulas, vedantes, tanques.
- Componentes das Bacias: Sistemas de fixação, tampos, tubos de descarga
- Componentes dos Bidés: Torneiras, válvulas, tampo, e fixação
- Componentes de Lavatórios: Torneiras, válvulas, fixações.

7.2 Para que a presente garantia seja válida, os equipamentos deverão ser instalados de acordo com as nossas instruções técnicas de montagem e operação.

7.3 A presente garantia não cobre reclamações que resultem de uso indevido, desgaste prematuro por condições de utilização não destinadas à sua configuração ou funcionalidade, alterações realizadas por terceiros, manutenção negligente, desadequação às instalações do Cliente.

**8. Reclamações**

8.1 Todas as reclamações relacionadas com a entrega de mercadorias (quebras, erros quantidade, faltas, etc) terão de ser efectuadas por escrito para os nossos serviços comerciais num período máximo de 5 dias úteis a contar da data (confirmada) de receção.

8.2 Qualquer reclamação de discordância de preços ou descontos praticados na fatura deverá ser efectuada por escrito para serviços comerciais até 15 dias após a data de receção da mesma.

8.3 Qualquer reclamação técnica ou de qualidade dos nossos produtos e mercadorias, deverá ser comunicada por escrito para os nossos serviços comerciais, com a descrição do problema, peças e quantificação de artigos envolvidos. O Cliente deverá garantir a guarda do material defeituoso até à sua substituição, sem custos para o Cliente, após devido processamento e aceitação de reclamação por parte da ARCH, SA.

8.4 A ARCH ,SA procederá de forma a assegurar uma resposta em tempo útil à reclamação de cada Cliente, cujo tempo de resolução estará condicionado pelo processo de análise de causas e a necessária clarificação de responsabilidades.

**9. Devoluções**

9.1 A ARCH, SA não aceitará qualquer devolução sem a prévia validação escrita do seu departamento Comercial e após devida fundamentação.

9.2 Não serão aceites devoluções de artigos sanitários em modelos e cores que não façam, à data, parte da gama comercializada.

9.3 Mercadorias e componentes não existentes no portfólio comercializado à data ou com tempo de venda superior à garantia comercial.

**10. Litígios**

10.1 O foro competente para dirimir qualquer litígio emergente das transações comerciais reguladas pelas presentes “condições gerais de Venda” é o da comarca de Vila Nova de Gaia.

10.2 De acordo com a lei n.º 144/2015 de 8 de Setembro, em caso de litígio o cliente pode recorrer ao Centro de Informação de Consumo e Arbitragem do Porto para resolução alternativa de litígios de consumo.

**CONDIÇÕES GERAIS DE PAGAMENTO**

1. Os fornecimentos a novos Clientes terão de ser liquidados por cheque ou numerário contra entrega da mercadoria. A abertura de crédito só poderá ser concedida após aprovação da Direção Financeira e da Direção Comercial da ARCH, SA.

2. Uma vez acordada a concessão de crédito e estabelecido o plafond respetivo, todas as faturas terão de ser liquidadas a um prazo máximo de 60 dias após a data de emissão.

3. No início de cada mês será emitido um resumo das faturas relativas ao mês anterior.

4. Serão concedidos descontos financeiros de acordo com as condições definidas em contrato com o Cliente ou aplicando regra geral de 2% de desconto financeiro a pronto pagamento.

5. A ARCH, SA reserva o direito de debitar juros compensatórios sempre que não se verifique o cumprimento das condições de pagamento aqui estabelecidas. Em caso algum será aceite como justificação para o não pagamento duma fatura, a existência de situações pendentes relativas a outros fornecimentos.

6. Haverá suspensão de fornecimentos sempre que ocorra uma das seguintes situações:

6.1 Pagamento de mercadorias seja efetuado com cheque sem provisão

6.2 Existam faturas vencidas por liquidar sem uma devida justificação

6.3 O plafond de crédito concedido tenha sido ultrapassado.

7. A nenhum Cliente com crédito suspenso será satisfeito qualquer encomenda, mesmo que o novo fornecimento seja contra pronto pagamento.

8. Em caso algum a ARCH, SA aceitará letras como forma de pagamento, mesmo que os encargos fiquem por conta do Cliente.

**CONDIÇÕES GERAIS**

1. A todos os preços da Tabela de Preços acresce o valor de I.V.A. à taxa em vigor.

2. Os preços da Tabela de Preços podem ser alterados sem aviso prévio.

3. As características e dimensões dos artigos constantes da Tabela de Preços estão sujeitas às tolerâncias técnicas regulamentadas em normas do sector de atividade.

4. Reserva-se o direito de eliminar e alterar referências a artigos e mercadorias comercializadas e constantes da Tabela de Preços.

## INTRODUCCIÓN

Todas las relaciones comerciales entre ARCH, S.A. y sus clientes son reguladas por las "condiciones generales de venta" que junto las "condiciones generales de pago" se consideran aceptadas integralmente por el comprador en el momento de la compra.

### 1. Catálogos, ofertas y pedidos

1.1 Todas las indicaciones y características que constan en la publicidad y material informativo están sujetas a las tolerancias establecidas por las reglas internas en conformidad con las normas del sector.

1.2 Cualquier pedido realizado a ARCH, S.A. se tendrá que hacer por escrito, con la debida identificación del cliente, fecha y descripción técnica conforme las referencias del producto.

1.3 Todos los pedidos serán para los debidos efectos sujetos a confirmación por escrito de la parte del cliente.

1.4 Cualquier condición estipulada por el cliente en sus pedidos y que no esté conforme con las presentes "condiciones de venta" así como en las "condiciones generales de pago" se considerarán sin efecto y serán confirmadas por escrito por ARCH, S.A. con posterioridad.

### 2. Cancelación de pedidos

2.1 ARCH, SA se reserva el derecho de cancelar un pedido en los siguientes casos:

- Cuando hubiera incumplimiento parcial o total de contratos anteriores.
- Cuando el cliente se niega a recibir la mercancía después de la expedición de la misma y mediante previa confirmación del pedido.
- Siempre que se constate un comportamiento indebido en detrimento de ARCH, S.A.

### 3. Entregas

3.1 Los plazos de entrega se definen entre ARCH, SA y el cliente durante el transcurso del pedido. Si no hubiera nada estipulado el plazo de referencia para la entrega es de 30 días laborables. Si no fuese posible garantizar un plazo estipulado, ARCH, S.A. se compromete a avisar el cliente con un nuevo plazo.

3.2 Todos los pedidos se podrán satisfacer mediante entregas parciales.

3.3 Todos los productos y mercancías que se hayan recogido a través del transporte del cliente se considerarán como entregados en el momento de su carga mediante la firma del albarán por el correspondiente conductor siempre y cuando la responsabilidad del transporte recaiga en el cliente. En estos casos no se aceptarán reclamaciones a posteriori sea por faltas o daños.

3.4 Cuando la responsabilidad del transporte recaiga en ARCH, S.A. la mercancía se considerará como entregada en el momento de la firma del albarán en el destino acordado.

3.5 El acto de recepción de la mercancía por parte del cliente implica la confirmación de su contenido y consecuente conformidad de acuerdo con el pedido efectuado y/o con los documentos del transporte que lo comprueben. Cualquier anomalía se deberá registrar en el albarán de ARCH, S.A. y en el respectivo documento de transporte.

3.6 En el caso que no se pueda comprobar la mercancía en el acto de entrega, el cliente tendrá que hacer referencia en el albarán y documento de transporte el siguiente comentario " sujeto a confirmación". Cualquier anomalía deberá ser comunicada por el cliente por escrito para nuestros servicios comerciales en tiempo útil y nunca superior a 5 días laborables después de la recepción de la mercancía.

3.7 ARCH, SA se puede negar a realizar un transporte de la mercancía en las siguientes circunstancias:

- Cuando el destino no sea el almacén del cliente o el local de entrega estipulado en el pedido.
- Cuando la cantidad pedida no lo justifique.
- Si el cliente se recusa a descargar la mercancía por motivos no imputables a ARCH, S.A. en cuyo caso se procederá al cargo del transporte y demás costes adicionales que puedan surgir como consecuencia de ese acto.
- ARCH, SA se reserva el derecho de considerar sin efecto todo pedido que quede en espera más de 30 días después de su disponibilidad sin que el cliente proceda a la respectiva recogida

### 4. Precios

4.1 Los precios practicados son los que constan en la tarifa de ARCH, S.A. en vigor en el momento de la expedición.

4.2 Se podrá alterar la tarifa sin previo aviso.

4.3 El cliente podrá anular en un plazo de 8 días laborables posteriores a la publicación de la nueva tarifa, cualquier pedido en curso no efectuado o expedido por ARCH, S.A.

4.4 Los pedidos en curso que no hayan sido anulados después del tiempo transcurrido para ese efecto tendrán como base los nuevos precios.

4.5 Los precios que constan en la tarifa serán siempre antes de los impuestos en vigor y los cuales aparecerán en las respectivas facturas.

4.6 Los precios de tarifa podrán sufrir un aumento según eventuales costes de expedición, transporte y/o embalaje especial que sean solicitados por el cliente y aceptados por ARCH S.A.

### 5. Pagos

5.1 El pago de facturas se rige por las "condiciones Generales de Pago" de ARCH, S.A. en vigor a la fecha de expedición.

5.2 Si el Cliente entra en mora, ARCH, SA se reserva el derecho de suspender los pedidos pendientes de servicio.

5.3 Siempre que ARCH, S.A. tome conocimiento de hechos y circunstancias que puedan originar un incumplimiento por parte del cliente, esta podrá suspender los pedidos en curso salvo mediante la presentación de garantías de pago fidedignas por parte del cliente y que sean previamente aprobadas por ARCH, S.A.

### 6. Garantía de Productos cerámicos

6.1 ARCH, S.A ofrece una garantía de 20 años sobre todos los artículos cerámicos Sanitarios de su autoría a partir de la fecha de venta.

6.2 Los artículos que durante ese período presenten algún problema técnico o de calidad evidente serán substituidos sin cualquier coste para el cliente y desde que sea responsabilidad de ARCH, S.A.

6.3 Es imprescindible que los defectos sean comunicados por escrito a los servicios comerciales de ARCH S.A. para que se produzca la activación de la mencionada garantía. Esa comunicación deberá ir acompañada de los documentos comprobantes de la venta y entrega por ARCH, S.A. para efectos de verificación de origen y fecha de entrega.

6.4 La aceptación de la reclamación estará condicionada por la validación técnica de nuestros servicios técnicos para un apuramiento de eventuales causas que puedan estar fuera de la cobertura de la garantía como el uso indebido y deficiente de la instalación o mantenimiento, desperfectos en el transporte, manipulaciones, reparaciones o alteraciones efectuadas por terceros sin un previo acuerdo o consentimiento por escrito.

6.5 La garantía sobre los productos cerámicos concebidos y producidos por ARCH, S.A. excluye toda y cualquier responsabilidad que transcurra de consecuencias relativas a la incompatibilidad técnica de las instalaciones del cliente, malas condiciones de operatividad

de las instalaciones, así como condiciones indebidas de almacenaje o manejo y no se aceptará ninguna reclamación por gastos con las mismas así como responsabilidades por daños y perjuicios.

6.6 Se repondrá el material reclamado en el espacio de tiempo más breve posible y de acuerdo con la disponibilidad del material igual al reclamado.

### 7. Garantía de componentes no cerámicos

7.1 ARCH, SA garantiza por un período de 2 años, desde la fecha de compra (comprobada), los productos no cerámicos que se siguen:

- Componentes de los mecanismos de descarga: Válvulas, aislantes, tanques.
- Componentes de los inodoros: Sistemas de fijación, tapas, tubos de descarga
- Componentes de los Bidés : Grifos, válvulas, tapas, y fijación
- Componentes de los lavabos: Grifos, válvulas, tapas, y fijaciones.

7.2 Para que la presente garantía sea válida, los equipos deberán ser instalados de acuerdo con nuestras instrucciones técnicas de montaje y operación.

7.3 La presente garantía no cubre reclamaciones que resulten del uso indebido, desgaste prematuro por condiciones de utilización no destinadas a su configuración o funcionalidad, alteraciones realizadas por terceros, mantenimiento negligente o inadaptación a las instalaciones del cliente.

### 8. Reclamaciones

8.1 Todas las reclamaciones relacionadas con la entrega de mercancías (quebras, errores de cantidad, faltas etc.) se tendrán que efectuar por escrito a nuestros servicios comerciales en un tiempo máximo de 5 días laborables a partir de la fecha (comprobada) de entrega.

8.2 Cualquier reclamación sobre la disputa de precios o descuentos constantes en la factura se tendrá que efectuar por escrito hasta 15 días después de la recepción de la misma.

8.3 Se deberá comunicar por escrito para nuestros servicios comerciales cualquier reclamación técnica o de calidad de nuestros productos y mercancías con la descripción del problema, piezas y cuantificación de los artículos en cuestión. El cliente deberá garantizar el almacenaje del material defectuoso hasta su sustitución, sin costes para el, y solamente después de la aceptación previa por parte de ARCH, S.A de la respectiva reclamación.

8.4 A ARCH, S.A siempre procederá de manera a dar una respuesta a la reclamación de cada cliente en tiempo útil y cuya solución dependa de las causas y el apuramiento de responsabilidades.

### 9. Devoluciones

9.1 ARCH, S.A. no aceptará cualquier devolución sin la aceptación previa por escrito del departamento comercial y mediante la debida fundamentación.

9.2 No se aceptarán devoluciones de artículos sanitarios cuyos modelos y colores no hagan parte de la gama actual en comercialización.

9.3 No se aceptarán mercancías y componentes que no existan en la gama comercializada presentemente o con tiempo de venta superior a la garantía comercial.

### 10. Litigios

10.1 El fuero competente para dirimir cualquier litigio resultante de las transacciones comerciales reglamentadas por las presentes "condiciones generales de venta" es el de la comarca de Vila Nova de Gaia.

10.2 De acuerdo con la Ley n° 144/2015 del 8 de Septiembre, em caso de litigio el cliente puede recurrir al " Centro de Informação de Consumo e Arbitragem" de Porto para una resolución alternativa de litigios al consumo.

### CONDICIONES GENERALES DE PAGO

1. Los suministros de nuevos clientes se tendrán que pagar mediante cheque o en efectivo al entregar la mercancía. La apertura de crédito solamente se podrá efectuar mediante la aprobación previa de la dirección Financiera y Comercial de ARCH, S.A.

2. Una vez que se aprueba la apertura de crédito y el respectivo límite, todas las facturas tendrán que ser liquidadas pasados 60 días de la fecha de emisión de las mismas.

3. Al inicio de cada mes se emitirá un resumen de las facturas del mes anterior.

4. Los descuentos financieros se concederán de acuerdo con las condiciones especificadas en el contrato de cada cliente o aplicando la regla general del 2% de descuento a pronto pago.

5. ARCH, SA se reserva el derecho a cobrar intereses de demora siempre y cuando no se verifiquen las condiciones de pago aqui establecidas. En ninguna circunstancia se aceptará como justificación del impago la existencia de situaciones pendientes relativas a otros suministros.

6. Habrá suspensión de suministros siempre que ocurra una de las siguientes situaciones:

6.1 Pago de mercancías con un cheque sin fondo.

6.2 Existencia de facturas en atraso sin la debida justificación.

6.3 Alcanzar el Límite de crédito.

7. No habrá nuevo suministro una vez que el crédito se encuentre anulado aún cuando el nuevo suministro sea a pronto pago.

8. En ningún caso se aceptarán letras de cambio como forma de pago aun cuando los gastos corran por cuenta del cliente.

### CONDICIONES GENERALES

1. Los precios en la tarifa no incluyen el IVA.

2. Los precios en la tarifa pueden sufrir alteraciones sin previo aviso.

3. Las características y dimensiones de los artículos que figuran en la tarifa se someterán a las tolerancias técnicas especificadas en las respectivas normas del sector.

4. Se reserva el derecho de eliminar o alterar referencias a artículos y mercancías constantes en la tarifa.

## INTRODUCTION

All commercial relations between ARCH, SA and its Clients are ruled by the following "General Terms of Sale" which, together with the "General Terms of Payment" are deemed to have been fully accepted by the purchaser at the time its order is made.

### 1. Catalogues, offers and orders

1.1 All indications and characteristics stated in our advertising material are subject to the tolerances defined in the Quality Assurance System in accordance with the standards in force for the sector.

1.2 Any order to ARCH, SA shall be made in writing by way of a duly numbered requisition on company headed paper, date and technical description on our catalogue references.

1.3 To all intents and purposes, all orders are subject to acceptance in writing.

1.4 Any condition stipulated by the Client in its requests which does not conform to the present "General Terms of Sale" or to the "General Terms of Payment" shall be deemed null and void, unless subsequently confirmed in writing by ARCH, SA.

### 2. Suspension of orders

2.1 ARCH, SA reserves the right to suspend the execution of any order in the following cases:

- When the Customer has not given partial or full compliance with previous contracts;
- When by the Customer to check refuses to receive their orders after loading and dispatch as prior order,
- Where there is Customer misconduct to the detriment of ARCH, SA.

### 3. Deliveries

3.1 The delivery dates are agreed upon between ARCH, SA and its Clients. Should nothing be formally stipulated by both parties, the delivery date to be assumed shall be

of 30 days. Whenever this cannot be met, ARCH, SA undertakes to notify the Client and agree upon a new date.

3.2 Any order may be carried out through partial deliveries.

3.3 The goods are deemed to have been delivered to the Client as soon as their loading onto the truck has been completed at ARCH, SA warehouse and the respective Delivery Slip has been signed by the driver, with transport being wholly the responsibility of the Client meaning that, in such cases, no complaints shall be accepted owing to the breakage of material or goods missing.

3.4 Whenever transport is carried out in transport chartered by ARCH, SA the goods shall be deemed to have been delivered upon their receipt at the destiny.

3.5 The Client shall verify upon receipt whether the products correspond to those ordered by it. Any irregularity shall be registered on ARCH, SA Delivery Slip as well as on the Transporter Slip.

3.6 Should it not be possible to verify the goods upon delivery, the Client shall write on the corresponding Delivery Slips and on the Transporter Slip "Subject to Conferral". Any irregularity detected shall be communicated to our commercial services in writing within no more than 5 days

3.7 ARCH, SA may refuse to transport orders whenever:

- The place of destination is not the Client's warehouse or that agreed upon previously;
- The volume of the order does not so justify.
- Whenever there is a refusal to receive, for reasons not attributable to ARCH, SA, the Client shall be charged an amount corresponding to the value of transport.
- ARCH, SA reserves the right to deem null and void any order remaining over 30 days after it was made without the Client having collected it.

### 4. Prices

4.1 The prices charged are always those set out in the Price Table of ARCH, SA in force at the time of dispatch of the goods.

4.2 The Price Table may be altered without any prior notice.

4.3 Owing to the coming into force of the new Price Table of ARCH, SA, and within eight days after its disclosure, the Client may cancel, in writing, any order yet to be implemented or dispatched by ARCH, SA.

4.4 In case of projects in study with deliveries scheduled for the coming year, the proposed prices shall have the validity of the budget even if some change in the price list occurs in that period.

4.5 The prices set out in the table shall be deemed to have been accepted by the Clients whenever their orders have not been subject to cancellation in accordance to the point.

4.6 The prices stated in the Table are always net of the taxes in force which shall always be itemised on the invoices.

4.7 Any expenses defrayed on dispatching goods in special packaging shall accrue to the prices stated in this price list whenever said packaging is requested by the Client and accepted by ARCH, SA.

### 5. Payments

5.1 The payment of invoices is subject to the "General Terms of Payment" of ARCH, SA in force as at the date of dispatch.

5.2 If the Client is late in making payment, ARCH, SA reserves the right to suspend the implementation and dispatch of any orders in portfolio.

5.3 Whenever ARCH, SA learns of any facts and circumstances which cause well-founded fears of breaches in compliance with obligations by the Client, it may suspend the delivery of goods, unless the purchaser provides guarantees in a timeframe to be agreed upon.

### 6. Guarantee of ceramic components

6.1 ARCH, SA gives guarantee of 20 years from buying date to all ceramic products conceived and produced by them.

6.2 All the ceramic wares that during this period show any problem due to any material defect or manufacturing one will be replaced to the customer for free.

6.3 In order to activate the guarantee it is necessary that all defects are communicated immediately by written to ARCH, SA, together with invoice or other document issued by us proving the origin and delivery date of the product.

6.4 The acceptance of the claim shall be conditioned by our Quality Department to verify causes non covered by this guarantee such as negligence, bad installation and/

or maintenance, transport damages, handling, repairs or intervention done by third parties without our Previous written permission.

6.5 The guarantee about ceramic products conceived and produced by ARCH, SA exclude all and any responsibility coming from technical



incompatibility of Client premises, bad conditions of installing process, and also improper storage or handling conditions. ARCH, SA shall not accept any claim of expenses occurred from those referred situations as well as legal responsibility for damages or prejudices.

6.6 The claimed material will be replaced by ARCH, SA in the shortest period and according to the availability of such material.

#### 7. Guarantee of non ceramic components

7.1 ARCH, SA grants 2 years guarantee from buying date (duly proved) on the bellow non-ceramic products:

- Discharge Mechanisms components: Valves, sealant system and plastic cisterns;
- WC components: Seats, fixation systems and discharge pipes;
- Bidet components: Taps, valves, seats and fixation systems;
- Washbasins components: Taps, valves and fixation systems.

7.2 This Guarantee comes in force always and when all the proceedings written on installation manual have been followed (if applicable).

7.3 The present guarantee does not cover claims occurring from the misuse, premature deterioration for usage conditions not designated to its configuration or functionality, changes done by third parties, negligent maintenance, inadequate to client's premises.

#### 8. Claims

8.1 As specified in 3.1 all claims related to the delivery of products (breaks, quantity errors, failures, etc) must be made in writing to Commercial Department within a period of 5 days from the date of receipt of the same.

8.2 Any claim owing to a disagreement over the prices or discounts made to the invoice shall be lodged in writing to Commercial Department within 15 days after receipt thereof.

8.3 Any technical or quality claim of our products must be communicated by written to our Commercial services with full description of the problem, pieces and quantification. The client must guarantee to keep the materials properly until its replacement after verification and acceptance of the claim by ARCH, SA.

8.4 ARCH, SA shall assure a reply in appropriate time to each Client claim, which resolution time shall be conditioned by the confirmation of responsibilities.

#### 9. Returns

9.1 ARCH, SA will not accept any return without the prior authorisation in writing of its Commercial Department.

9.2 Under no circumstances shall returns be accepted of sanitary ware in models or colours which do not, to date, form part of the current range

9.3 All products and components non existent in the catalogue to date or with selling date superior to commercial guarantee.

9.4 The charges with the return process of all the products shall be on the Clients responsibility.

#### 10. Disputes

10.1 The competent venue for settling any litigation arising out of the commercial transactions regulated by the present "General Terms of Sale" is the District of Vila Nova de Gaia.

10.2 According to Law No. 144/2015 of September 8, in the event of litigation the customer may use the Consumer Information and Arbitration Center of PORTO for alternative resolution of consumer disputes

#### GENERAL TERMS OF PAYMENT

1. Supplies to new Clients must be paid upon delivery of goods. Credit shall only be granted after approval of the Financial Management and the Commercial of ARCH, SA.

2. Once it has been agreed to grant credit and the respective limit has been established, all invoices must be settled within 60 days after the date of the respective issue.

3. At the start of each month a summary of invoices shall be issued relating to the previous month.

4. A prompt payment discount shall be granted (in cheque, cash or bank transfer) with order acceptance, or with payment in the delivery date, or by payment at loading date, or by financial discount with payment till 15 days after invoice date, according personalized conditions.

5. ARCH, SA has the right to cancel given discounts all the time the terms of payment previously established are not fulfilled.

6. Supplies shall be suspended in the event of any of the following situations:

6.1 The payment of the goods and/or costs has been made with a bouncing cheque;

6.2 There are documents due and unpaid without proper justification;

6.3 The credit plafond assigned has been exceeded.

7. Any Client whose credit has been suspended cannot make an order even if prompt payment is made

8. In any case, ARCH, SA shall accept bill of exchanges as payment, even with charges on client's account.

#### GENERAL CONDITIONS

1. All prices in the price list are subject to vat at the legal rate in force.

2. Prices may be changed without prior notice.

3. The characteristics and measurements shown are subject to some technical tolerances, according to the norms of this activity sector.

4. We reserve the right to alter and/or eliminate products shown in this price list

5. The commercialisation of the aforementioned products is subject to the general terms of sale and payment set out in this price list.

Cofinanciado por:



**SEDE / FÁBRICA** | HEADQUARTERS/ FACTORY  
Av. António Coelho Moreira  
4405-528 Vila Nova de Gaia  
Portugal

+351 223 238 038  
comercial@archvaladares.com

**www.archvaladares.com**  
**www.arch.pt**